

Programmable Controller

MELSEC **Q**series MELSEC *L*series

MELSEC-Q/L

QD77MS/QD77GF/LD77MS/LD77MH

Simple Motion Module

User's Manual (Synchronous Control)

---

-QD77MS2  
-QD77MS4  
-QD77MS16

-QD77GF4  
-QD77GF8  
-QD77GF16

-LD77MS2  
-LD77MS4  
-LD77MS16

-LD77MH4  
-LD77MH16

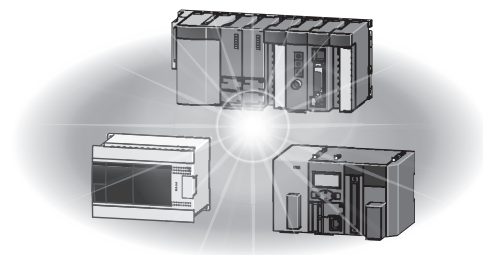



## ● SAFETY PRECAUTIONS ●

(Please read these instructions before using this equipment.)

Before using this product, please read this manual and the relevant manuals introduced in this manual carefully and pay full attention to safety to handle the product correctly.

The precautions given in this manual are concerned with this product only. Refer to the user's manual of the CPU module to use for a description of the PLC system safety precautions.

In this manual, the safety instructions are ranked as "DANGER" and "CAUTION".

 **DANGER**

Indicates that incorrect handling may cause hazardous conditions, resulting in death or severe injury.

 **CAUTION**

Indicates that incorrect handling may cause hazardous conditions, resulting in medium or slight personal injury or physical damage.

Depending on circumstances, procedures indicated by  CAUTION may also be linked to serious results.

In any case, it is important to follow the directions for usage.

Please save this manual to make it accessible when required and always forward it to the end user.

## For Safe Operations

### 1. Prevention of electric shocks

#### DANGER

- Never open the front case or terminal covers while the power is ON or the unit is running, as this may lead to electric shocks.
- Never run the unit with the front case or terminal cover removed. The high voltage terminal and charged sections will be exposed and may lead to electric shocks.
- Never open the front case or terminal cover at times other than wiring work or periodic inspections even if the power is OFF. The insides of the module and servo amplifier are charged and may lead to electric shocks.
- Completely turn off the externally supplied power used in the system before mounting or removing the module, performing wiring work, or inspections. Failing to do so may lead to electric shocks.
- When performing wiring work or inspections, turn the power OFF, wait at least ten minutes, and then check the voltage with a tester, etc. Failing to do so may lead to electric shocks.
- Be sure to ground the module, servo amplifier and servomotor (Ground resistance: 100  $\Omega$  or less). Do not ground commonly with other devices.
- The wiring work and inspections must be done by a qualified technician.
- Wire the units after installing the module, servo amplifier and servomotor. Failing to do so may lead to electric shocks or damage.
- Never operate the switches with wet hands, as this may lead to electric shocks.
- Do not damage, apply excessive stress, place heavy things on or sandwich the cables, as this may lead to electric shocks.
- Do not touch the module, servo amplifier, servomotor connector or terminal blocks while the power is ON, as this may lead to electric shocks.
- Do not touch the built-in power supply, built-in grounding or signal wires of the module and servo amplifier, as this may lead to electric shocks.

### 2. For fire prevention

#### CAUTION

- Install the module, servo amplifier, servomotor and regenerative resistor on incombustible. Installing them directly or close to combustibles will lead to fire.
- If a fault occurs in the module or servo amplifier, shut the power OFF at the servo amplifier's power source. If a large current continues to flow, fire may occur.
- When using a regenerative resistor, shut the power OFF with an error signal. The regenerative resistor may abnormally overheat due to a fault in the regenerative transistor, etc., and may lead to fire.
- Always take heat measures such as flame proofing for the inside of the control panel where the servo amplifier or regenerative resistor is installed and for the wires used. Failing to do so may lead to fire.
- Do not damage, apply excessive stress, place heavy things on or sandwich the cables, as this may lead to fire.

### 3. For injury prevention

#### CAUTION

- Do not apply a voltage other than that specified in the instruction manual on any terminal. Doing so may lead to destruction or damage.
- Do not mistake the terminal connections, as this may lead to destruction or damage.
- Do not mistake the polarity (+ / -), as this may lead to destruction or damage.
- Do not touch the heat radiating fins of module or servo amplifier, regenerative resistor and servomotor, etc., while the power is ON and for a short time after the power is turned OFF. In this timing, these parts become very hot and may lead to burns.
- Always turn the power OFF before touching the servomotor shaft or coupled machines, as these parts may lead to injuries.
- Do not go near the machine during test operations or during operations such as teaching. Doing so may lead to injuries.

### 4. Various precautions

Strictly observe the following precautions. Mistaken handling of the unit may lead to faults, injuries or electric shocks.

#### (1) System structure

#### CAUTION

- Always install a leakage breaker on the module and servo amplifier power source.
- If installation of an electromagnetic contactor for power shut off during an error, etc., is specified in the instruction manual for the servo amplifier, etc., always install the electromagnetic contactor.
- Install the emergency stop circuit externally so that the operation can be stopped immediately and the power shut off.
- Use the module, servo amplifier, servomotor and regenerative resistor with the correct combinations listed in the instruction manual. Other combinations may lead to fire or faults.
- Use the CPU module, base unit, and Simple Motion module with the correct combinations listed in the instruction manual. Other combinations may lead to faults.
- If safety standards (ex., robot safety rules, etc.,) apply to the system using the module, servo amplifier and servomotor, make sure that the safety standards are satisfied.
- Construct a safety circuit externally of the module or servo amplifier if the abnormal operation of the module or servo amplifier differs from the safety directive operation in the system.
- In systems where coasting of the servomotor will be a problem during the forced stop, emergency stop, servo OFF or power supply OFF, use the dynamic brake.
- Make sure that the system considers the coasting amount even when using the dynamic brake.
- In systems where perpendicular shaft dropping may be a problem during the forced stop, emergency stop, servo OFF or power supply OFF, use both the dynamic brake and electromagnetic brake.
- The dynamic brake must be used only on errors that cause the forced stop, emergency stop, or servo OFF. This brake must not be used for normal braking.
- The brake (electromagnetic brake) assembled into the servomotor are for holding applications, and must not be used for normal braking.

## CAUTION

- The system must have a mechanical allowance so that the machine itself can stop even if the stroke limits switch is passed through at the max. speed.
- Use wires and cables that have a wire diameter, heat resistance and bending resistance compatible with the system.
- Use wires and cables within the length of the range described in the instruction manual.
- The ratings and characteristics of the parts (other than module, servo amplifier and servomotor) used in a system must be compatible with the module, servo amplifier and servomotor.
- Install a cover on the shaft so that the rotary parts of the servomotor are not touched during operation.
- There may be some cases where holding by the electromagnetic brake is not possible due to the life or mechanical structure (when the ball screw and servomotor are connected with a timing belt, etc.). Install a stopping device to ensure safety on the machine side.

### (2) Parameter settings and programming

## DANGER

- Set the parameter values to those that are compatible with the module, servo amplifier, servomotor and regenerative resistor model and the system application. The protective functions may not function if the settings are incorrect.
- The regenerative resistor model and capacity parameters must be set to values that conform to the operation mode and servo amplifier. The protective functions may not function if the settings are incorrect.
- Set the mechanical brake output and dynamic brake output validity parameters to values that are compatible with the system application. The protective functions may not function if the settings are incorrect.
- Set the stroke limit input validity parameter to a value that is compatible with the system application. The protective functions may not function if the setting is incorrect.
- Set the servomotor encoder type (increment, absolute position type, etc.) parameter to a value that is compatible with the system application. The protective functions may not function if the setting is incorrect.
- Use the program commands for the program with the conditions specified in the instruction manual.
- Set the sequence function program capacity setting, device capacity, latch validity range, I/O assignment setting, and validity of continuous operation during error detection to values that are compatible with the system application. The protective functions may not function if the settings are incorrect.

## DANGER

- The input devices and data registers assigned to the link will hold the data previous to when communication is terminated by an error, etc. Thus, an error correspondence interlock program specified in the instruction manual must be used.
- Use the interlock program specified in the intelligent function module's instruction manual for the program corresponding to the intelligent function module.
- When connecting GX Works2 with the CPU module or connecting a personal computer with an intelligent function module to modify data of a running programmable controller, configure an interlock circuit in the program to ensure that the entire system will always operate safely. For other forms of control (such as program modification or operating status change) of a running programmable controller, read the relevant manuals carefully and ensure that the operation is safe before proceeding. Especially, when a remote programmable controller is controlled by an external device, immediate action cannot be taken if a problem occurs in the programmable controller due to a communication failure. To prevent this, configure an interlock circuit in the program, and determine corrective actions to be taken between the external device and CPU module in case of a communication failure.
- For the operating status of each station after a communication failure, refer to the "MELSEC-Q QD77GF Simple Motion Module User's Manual (Network)". Incorrect output or malfunction due to a communication failure may result in an accident.
- Do not write any data to the "system area" of the buffer memory in the intelligent function module. Also, do not use any "use prohibited" signals as an output signal from the CPU module to the intelligent function module.  
Doing so may cause malfunction of the programmable controller system.
- To set a refresh device in the network parameter, select the device Y for the remote output (RY) refresh device. If a device other than Y, such as M and L, is selected, the CPU module holds the device status even after its status is changed to STOP.
- If a communication cable is disconnected, the network may be unstable, resulting in a communication failure of multiple stations. Configure an interlock circuit in the program to ensure that the entire system will always operate safely even if communications fail.  
Failure to do so may result in an accident due to an incorrect output or malfunction.

### (3) Transportation and installation

## DANGER

- Shut off the external power supply (all phases) used in the system before mounting or removing a module. Failure to do so may result in electric shock or cause the module to fail or malfunction.

## ⚠ CAUTION

- Transport the product with the correct method according to the mass.
- Use the servomotor suspension bolts only for the transportation of the servomotor. Do not transport the servomotor with machine installed on it.
- Do not stack products past the limit.
- When transporting the module or servo amplifier, never hold the connected wires or cables.
- When transporting the servomotor, never hold the cables, shaft or detector.
- When transporting the module or servo amplifier, never hold the front case as it may fall off.
- When transporting, installing or removing the module or servo amplifier, never hold the edges.
- Install the unit according to the instruction manual in a place where the mass can be withstood.
- Do not get on or place heavy objects on the product.
- Always observe the installation direction.
- Keep the designated clearance between the module or servo amplifier and control panel inner surface or the module and servo amplifier, module or servo amplifier and other devices.
- Do not install or operate modules, servo amplifiers or servomotors that are damaged or that have missing parts.
- Do not block the intake/outtake ports of the servo amplifier and servomotor with cooling fan.
- Do not allow conductive matter such as screw or cutting chips or combustible matter such as oil enter the module, servo amplifier or servomotor.
- The module, servo amplifier and servomotor are precision machines, so do not drop or apply strong impacts on them.
- Securely fix the module, servo amplifier and servomotor to the machine according to the instruction manual. If the fixing is insufficient, these may come off during operation.
- Always install the servomotor with reduction gears in the designated direction. Failing to do so may lead to oil leaks.
- Store and use the unit in the following environmental conditions.

Environment	Conditions	
	Module/Servo amplifier	Servomotor
Ambient temperature	According to each instruction manual.	0°C to +40°C (With no freezing) (32°F to +104°F)
Ambient humidity	According to each instruction manual.	80% RH or less (With no dew condensation)
Storage temperature	According to each instruction manual.	-20°C to +65°C (-4°F to +149°F)
Atmosphere	Indoors (where not subject to direct sunlight). No corrosive gases, flammable gases, oil mist or dust must exist	
Altitude	According to each instruction manual	
Vibration	According to each instruction manual	

- When coupling with the servomotor shaft end, do not apply impact such as by hitting with a hammer. Doing so may lead to detector damage.
- Do not apply a load larger than the tolerable load onto the servomotor shaft. Doing so may lead to shaft breakage.



## CAUTION

- When not using the module for a long time, disconnect the power line from the module or servo amplifier.
- Place the module and servo amplifier in static electricity preventing vinyl bags and store.
- When storing for a long time, please contact with our sales representative.  
Also, execute a trial operation.
- Make sure that the connectors for the servo amplifier and peripheral devices have been securely installed until a click is heard.  
Not doing so could lead to a poor connection, resulting in erroneous input and output.
- Use the programmable controller in an environment that meets the general specifications in the user's manual for the CPU module used. Failure to do so may result in electric shock, fire, malfunction, or damage to or deterioration of the product.
- To mount the module, while pressing the module mounting lever located in the lower part of the module, fully insert the module fixing projection(s) into the hole(s) in the base unit and press the module until it snaps into place. Incorrect mounting may cause malfunction, failure or drop of the module.  
When using the programmable controller in an environment of frequent vibrations, fix the module with a screw.
- Tighten the screws within the specified torque range. Undertightening can cause drop of the screw, short circuit or malfunction. Overtightening can damage the screw and/or module, resulting in drop, short circuit, or malfunction.
- Do not directly touch any conductive parts and electronic components of the module. Doing so can cause malfunction or failure of the module.
- When fumigants that contain halogen materials such as fluorine, chlorine, bromine, and iodine are used for disinfecting and protecting wooden packaging from insects, they cause malfunction when entering our products.  
Please take necessary precautions to ensure that remaining materials from fumigant do not enter our products, or treat packaging with methods other than fumigation (heat method). Additionally, disinfect and protect wood from insects before packing products.
- The module and the servo amplifier must not be used with parts which contain halogen-series flame retardant materials (such as bromine) under coexisting conditions.

### (4) Wiring

## DANGER

- Shut off the external power supply (all phases) used in the system before wiring.  
Failure to do so may result in electric shock or cause the module to fail or malfunction.

## ⚠ CAUTION

- Correctly and securely wire the wires. Reconfirm the connections for mistakes and the terminal screws for tightness after wiring. Failing to do so may lead to run away of the servomotor.
- After wiring, install the protective covers such as the terminal covers to the original positions.
- Do not install a phase advancing capacitor, surge absorber or radio noise filter (option FR-BIF) on the output side of the servo amplifier.
- Correctly connect the output side (terminal U, V, W). Incorrect connections will lead the servomotor to operate abnormally.
- Do not connect a commercial power supply to the servomotor, as this may lead to trouble.
- Do not mistake the direction of the surge absorbing diode installed on the DC relay for the control signal output of brake signals, etc. Incorrect installation may lead to signals not being output when trouble occurs or the protective functions not functioning.

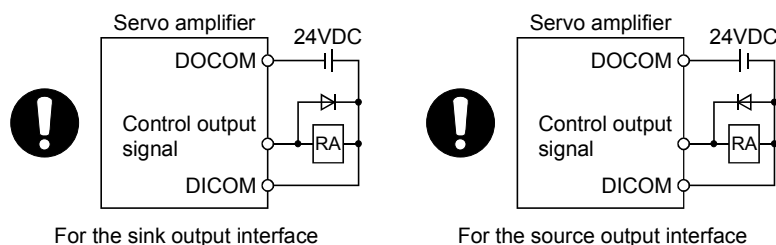

- Do not connect or disconnect the connection cables between each unit, the encoder cable or PLC expansion cable while the power is ON.
- Securely tighten the cable connector fixing screws and fixing mechanisms. Insufficient fixing may lead to the cables coming off during operation.
- Do not bundle the power line or cables.
- Use applicable solderless terminals and tighten them with the specified torque.  
If any solderless spade terminal is used, it may be disconnected when the terminal screw comes loose, resulting in failure.
- Do not install the control lines or communication cables together with the main circuit lines or power cables. Keep a distance of 100mm or more between them. Failure to do so may result in malfunction due to noise.
- Prevent foreign matter such as dust or wire chips from entering the module. Such foreign matter can cause a fire, failure, or malfunction.
- A protective film is attached to the top of the module to prevent foreign matter, such as wire chips, from entering the module during wiring. Do not remove the film during wiring. Remove it for heat dissipation before system operation.
- Place the cables in a duct or clamp them. If not, dangling cable may swing or inadvertently be pulled, resulting in damage to the module or cables or malfunction due to poor contact.
- When disconnecting the cable from the module, do not pull the cable by the cable part. For the cable with connector, hold the connector part of the cable. Pulling the cable connected to the module may result in malfunction or damage to the module or cable.
- Use 1000BASE-T-compliant Ethernet cables for Ethernet connection. For the maximum station-to-station distance and the overall cable distance, follow the specifications in this manual. If not, normal data transmission is not guaranteed.

## (5) Trial operation and adjustment

### CAUTION

- Confirm and adjust the program and each parameter before operation. Unpredictable movements may occur depending on the machine.
- Extreme adjustments and changes may lead to unstable operation, so never make them.
- When using the absolute position system function, on starting up, and when the module or absolute position motor has been replaced, always perform a home position return.
- Before starting test operation, set the parameter speed limit value to the slowest value, and make sure that operation can be stopped immediately by the forced stop, etc. if a hazardous state occurs.
- Before starting the operation, confirm the brake function.

(6) Usage methods

**⚠ CAUTION**

- Immediately turn OFF the power if smoke, abnormal sounds or odors are emitted from the module, servo amplifier or servomotor.
- Always execute a test operation before starting actual operations after the program or parameters have been changed or after maintenance and inspection.
- Do not attempt to disassemble and repair the units excluding a qualified technician whom our company recognized.
- Do not make any modifications to the unit.
- Keep the effect or electromagnetic obstacles to a minimum by installing a noise filter or by using wire shields, etc.  
Electromagnetic obstacles may affect the electronic devices used near the module or servo amplifier.
- When using the CE Mark-compliant equipment design, refer to the "EMC Installation Guidelines" (data number IB(NA)-67339) and refer to the corresponding EMC guideline information for the servo amplifiers and other equipment.
- Note that when the reference axis speed is designated for interpolation operation, the speed of the partner axis (2nd axis, 3rd axis and 4th axis) may be larger than the set speed (larger than the speed limit value).
- Use the units with the following conditions.

1) QD77MS/QD77GF

Item	Conditions
Input power	According to each instruction manual.
Input frequency	According to each instruction manual.
Tolerable momentary power failure	According to each instruction manual.

2) LD77MS/LD77MH

Item	Conditions	
	L61P	L63P
Input power	100 to 240VAC <sup>+10%</sup> <sub>-15%</sub> (85 to 264VAC)	24VDC <sup>+30%</sup> <sub>-35%</sub> (15.6 to 31.2VDC)
Input frequency	50/60Hz ±5%	
Tolerable momentary power failure	10ms or less	

## (7) Corrective actions for errors

### ⚠ CAUTION

- If an error occurs in the self diagnosis of the module or servo amplifier, confirm the check details according to the instruction manual, and restore the operation.
- If a dangerous state is predicted in case of a power failure or product failure, use a servomotor with an electromagnetic brake or install a brake mechanism externally.
- Use a double circuit construction so that the electromagnetic brake operation circuit can be operated by emergency stop signals set externally.

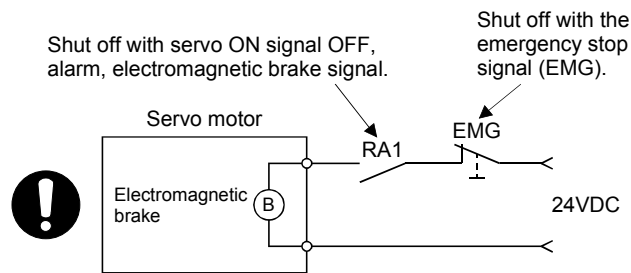

- If an error occurs, remove the cause, secure the safety and then resume operation after alarm release.
- The unit may suddenly resume operation after a power failure is restored, so do not go near the machine. (Design the machine so that personal safety can be ensured even if the machine restarts suddenly.)

## (8) Maintenance, inspection and part replacement

### ⚠ DANGER

- Do not touch any terminal while power is on. Doing so will cause electric shock or malfunction.
- Shut off the external power supply (all phases) used in the system before cleaning the module or retightening the module fixing screw. Failure to do so may result in electric shock.

## CAUTION

- Before performing online operations (especially, program modification, forced output, and operating status change) for the running CPU module on another station from GX Works2 over CC-Link IE Field Network, read relevant manuals carefully and ensure the safety. Improper operation may damage machines or cause accidents.
- Do not disassemble or modify the modules. Doing so may cause failure, malfunction, injury, or a fire.
- Use any radio communication device such as a cellular phone or PHS (Personal Handy-phone System) more than 25cm away in all directions from the programmable controller. Failure to do so may cause malfunction.
- Shut off the external power supply (all phases) used in the system before mounting or removing a module. Failure to do so may cause the module to fail or malfunction.
- Tighten the screw within the specified torque range. Undertightening can cause drop of the screw, short circuit or malfunction. Overtightening can damage the screw and/or module, resulting in drop, short circuit, or malfunction.
- Perform the daily and periodic inspections according to the instruction manual.
- Perform maintenance and inspection after backing up the program and parameters for the module and servo amplifier.
- Do not place fingers or hands in the clearance when opening or closing any opening.
- Periodically replace consumable parts such as batteries according to the instruction manual.
- Do not touch the lead sections such as ICs or the connector contacts.
- Before touching the module, always touch grounded metal, etc. to discharge static electricity from human body. Failure to do so may cause the module to fail or malfunction.
- Do not directly touch the module's conductive parts and electronic components.  
Touching them could cause an operation failure or give damage to the module.
- Do not place the module or servo amplifier on metal that may cause a power leakage or wood, plastic or vinyl that may cause static electricity buildup.
- Do not perform a megger test (insulation resistance measurement) during inspection.
- When replacing the module or servo amplifier, always set the new module settings correctly.

## ⚠ CAUTION

- When the module or absolute position motor has been replaced, carry out a home position return operation using the following method, otherwise position displacement could occur.
  - After writing the servo data to the Simple Motion module using programming software, switch on the power again, then perform a home position return operation.
- After maintenance and inspections are completed, confirm that the position detection of the absolute position detector function is correct.
- Do not drop or impact the battery installed to the module.  
Doing so may damage the battery, causing battery liquid to leak in the battery. Do not use the dropped or impacted battery, but dispose of it.
- Do not short circuit, charge, overheat, incinerate or disassemble the batteries.
- The electrolytic capacitor will generate gas during a fault, so do not place your face near the module or servo amplifier.
- The electrolytic capacitor and fan will deteriorate. Periodically replace these to prevent secondary damage from faults. Please contact with our sales representative.
- Lock the control panel and prevent access to those who are not certified to handle or install electric equipment.
- Do not mount/remove the module and base or terminal block more than 50 times (IEC61131-2-compliant), after the first use of the product. Failure to do so may cause malfunction.
- Do not burn or break a module and servo amplifier. Doing so may cause a toxic gas.

### (9) About processing of waste

When you discard module, servo amplifier, a battery (primary battery) and other option articles, please follow the law of each country (area).

## ⚠ CAUTION

- This product is not designed or manufactured to be used in equipment or systems in situations that can affect or endanger human life.
- When considering this product for operation in special applications such as machinery or systems used in passenger transportation, medical, aerospace, atomic power, electric power, or submarine repeating applications, please contact your nearest Mitsubishi sales representative.
- Although this product was manufactured under conditions of strict quality control, you are strongly advised to install safety devices to forestall serious accidents when it is used in facilities where a breakdown in the product is likely to cause a serious accident.

### (10) General cautions

- All drawings provided in the instruction manual show the state with the covers and safety partitions removed to explain detailed sections. When operating the product, always return the covers and partitions to the designated positions, and operate according to the instruction manual.

## ● CONDITIONS OF USE FOR THE PRODUCT ●

- (1) Mitsubishi programmable controller ("the PRODUCT") shall be used in conditions;
  - i) where any problem, fault or failure occurring in the PRODUCT, if any, shall not lead to any major or serious accident; and
  - ii) where the backup and fail-safe function are systematically or automatically provided outside of the PRODUCT for the case of any problem, fault or failure occurring in the PRODUCT.
- (2) The PRODUCT has been designed and manufactured for the purpose of being used in general industries. MITSUBISHI SHALL HAVE NO RESPONSIBILITY OR LIABILITY (INCLUDING, BUT NOT LIMITED TO ANY AND ALL RESPONSIBILITY OR LIABILITY BASED ON CONTRACT, WARRANTY, TORT, PRODUCT LIABILITY) FOR ANY INJURY OR DEATH TO PERSONS OR LOSS OR DAMAGE TO PROPERTY CAUSED BY the PRODUCT THAT ARE OPERATED OR USED IN APPLICATION NOT INTENDED OR EXCLUDED BY INSTRUCTIONS, PRECAUTIONS, OR WARNING CONTAINED IN MITSUBISHI'S USER, INSTRUCTION AND/OR SAFETY MANUALS, TECHNICAL BULLETINS AND GUIDELINES FOR the PRODUCT.

("Prohibited Application")

Prohibited Applications include, but not limited to, the use of the PRODUCT in;

- Nuclear Power Plants and any other power plants operated by Power companies, and/or any other cases in which the public could be affected if any problem or fault occurs in the PRODUCT.
- Railway companies or Public service purposes, and/or any other cases in which establishment of a special quality assurance system is required by the Purchaser or End User.
- Aircraft or Aerospace, Medical applications, Train equipment, transport equipment such as Elevator and Escalator, Incineration and Fuel devices, Vehicles, Manned transportation, Equipment for Recreation and Amusement, and Safety devices, handling of Nuclear or Hazardous Materials or Chemicals, Mining and Drilling, and/or other applications where there is a significant risk of injury to the public or property.

Notwithstanding the above, restrictions Mitsubishi may in its sole discretion, authorize use of the PRODUCT in one or more of the Prohibited Applications, provided that the usage of the PRODUCT is limited only for the specific applications agreed to by Mitsubishi and provided further that no special quality assurance or fail-safe, redundant or other safety features which exceed the general specifications of the PRODUCTS are required. For details, please contact the Mitsubishi representative in your region.



## INTRODUCTION

Thank you for purchasing our MELSEC-Q/L series programmable controllers.

This manual describes the functions and programming of the Simple Motion module.

Before using this product, please read this manual and the relevant manuals carefully and develop familiarity with the functions and performance of the MELSEC-Q/L series programmable controller to handle the product correctly.

When applying the program examples introduced in this manual to the actual system, ensure the applicability and confirm that it will not cause system control problems.

Please make sure that the end users read this manual.

### REMARK

- Unless otherwise specified, this manual describes the program examples in which the I/O numbers of X/Y00 to X/Y1F are assigned for a Simple Motion module. I/O number assignment is required for using the program examples described in the manual.

For I/O number assignment, refer to the following.

- QnUCPU User's Manual (Function Explanation, Program Fundamentals)
- Qn(H)/QnPH/QnPRHCPU User's Manual (Function Explanation, Program Fundamentals)
- MELSEC-L CPU Module User's Manual (Function Explanation, Program Fundamentals)
- Operating procedures are explained using GX Works2.

REVISIONS

\* The manual number is given on the bottom left of the back cover.

Print Date	* Manual Number	Revision
Mar., 2011	IB(NA)-0300174-A	First edition
Feb., 2012	IB(NA)-0300174-B	[Additional model] QD77MS [Additional correction/partial correction] Processing time of cam auto-generation
Mar., 2013	IB(NA)-0300174-C	[Additional model] QD77GF
Jul., 2013	IB(NA)-0300174-D	[Additional model] LD77MS [Additional function] Synchronous encoder via servo amplifier
Feb., 2014	IB(NA)-0300174-E	[Additional correction/partial correction] Speed-torque control mode (QD77GF), Synchronous encoder via servo amplifier
Nov., 2014	IB(NA)-0300174-F	[Additional function] MR-JE-B [Additional correction/partial correction] Search for the cam axis current value per cycle
Apr., 2016	IB(NA)-0300174-G	[Additional model] QD77GF4/QD77GF8 [Additional function] Communication mode switching (QD77GF), Synchronous encoder via servo amplifier (QD77GF) [Additional correction/partial correction] SAFETY PRECAUTIONS, RELEVANT MANUALS, MANUAL PAGE ORGANIZATION, TERMS, Synchronous encoder via servo amplifier, Cam Function, Slippage method smoothing, Phase compensation of delay time of the input axis, WARRANTY
Feb., 2017	IB(NA)-0300174-H	[Additional correction/partial correction] Synchronous encoder axis parameters, Cam axis current value per cycle restoration, Cam reference position restoration, Cam axis feed current value restoration
Jun., 2017	IB(NA)-0300174-J	[Additional function] Command generation axis, MR-JE-BF [Additional correction/partial correction] Performance specifications, Main shaft parameters, Main shaft clutch parameters, Auxiliary shaft module, Auxiliary shaft clutch parameters, Phase compensation function, List of input axis errors

Japanese Manual Version IB-0300166

This manual confers no industrial property rights of any other kind, nor does it confer any patent licenses. Mitsubishi Electric Corporation cannot be held responsible for any problems involving industrial property rights which may occur as a result of using the contents noted in this manual.

© 2011 MITSUBISHI ELECTRIC CORPORATION

## CONTENTS

SAFETY PRECAUTIONS.....	A- 1
CONDITIONS OF USE FOR THE PRODUCT .....	A-14
INTRODUCTION.....	A-15
REVISIONS .....	A-16
CONTENTS.....	A-17
COMPLIANCE WITH THE EMC AND LOW VOLTAGE DIRECTIVES.....	A-20
RELEVANT MANUALS .....	A-21
MANUAL PAGE ORGANIZATION .....	A-25
TERMS .....	A-27
PACKING LIST.....	A-28

<b>1. Outline of Synchronous Control</b>	<b>1- 1 to 1-16</b>
--	---------------------

1.1 Outline of synchronous control .....	1- 2
1.2 Performance specifications.....	1- 6
1.3 Restrictions by the SERIAL No. and version .....	1- 9
1.4 Operation method of synchronous control .....	1-11
1.4.1 Synchronous control execution procedure.....	1-11
1.4.2 Starting/ending for synchronous control.....	1-12
1.4.3 Stop operation of output axis .....	1-14

<b>2. Input Axis Module</b>	<b>2- 1 to 2-60</b>
-----------------------------	---------------------

2.1 Servo input axis.....	2- 2
2.1.1 Overview of servo input axis .....	2- 2
2.1.2 Servo input axis parameters .....	2- 4
2.1.3 Servo input axis monitor data .....	2- 8
2.2 Command generation axis.....	2-10
2.2.1 Overview of command generation axis .....	2-10
2.2.2 Command generation axis parameters .....	2-15
2.2.3 Command generation axis control data.....	2-19
2.2.4 Command generation axis monitor data .....	2-24
2.2.5 Command generation axis positioning data .....	2-29
2.2.6 Write/read method for command generation axis parameter and positioning data.....	2-31
2.3 Synchronous encoder axis .....	2-35
2.3.1 Overview of synchronous encoder axis.....	2-35
2.3.2 Setting method for synchronous encoder .....	2-38
2.3.3 Synchronous encoder axis parameters.....	2-46
2.3.4 Synchronous encoder axis control data .....	2-54
2.3.5 Synchronous encoder axis monitor data.....	2-58

<b>3. Cam Function</b>	<b>3- 1 to 3-20</b>
------------------------	---------------------

3.1 Control details for cam function .....	3- 2
3.2 Create cam data.....	3-10
3.2.1 Memory configuration of cam data .....	3-10
3.2.2 Cam data operation function.....	3-13

3.2.3 Cam auto-generation function .....	3-17
--	------

<b>4. Synchronous Control</b>	<b>4- 1 to 4-66</b>
-------------------------------	---------------------

4.1 Main shaft module .....	4- 2
4.1.1 Overview of main shaft module .....	4- 2
4.1.2 Main shaft parameters .....	4- 3
4.1.3 Main shaft clutch parameters .....	4- 6
4.1.4 Main shaft clutch control data .....	4-14
4.2 Auxiliary shaft module .....	4-15
4.2.1 Overview of auxiliary shaft module .....	4-15
4.2.2 Auxiliary shaft parameters .....	4-16
4.2.3 Auxiliary shaft clutch parameters .....	4-19
4.2.4 Auxiliary shaft clutch control data .....	4-27
4.3 Clutch .....	4-28
4.3.1 Overview of clutch .....	4-28
4.3.2 Control method for clutch .....	4-28
4.3.3 Smoothing method for clutch .....	4-35
4.3.4 Use example of clutch .....	4-40
4.4 Speed change gear module .....	4-41
4.4.1 Overview of speed change gear module .....	4-41
4.4.2 Speed change gear parameters .....	4-42
4.5 Output axis module .....	4-44
4.5.1 Overview of output axis module .....	4-44
4.5.2 Output axis parameters .....	4-46
4.6 Synchronous control change function .....	4-50
4.6.1 Overview of synchronous control change function .....	4-50
4.6.2 Synchronous control change control data .....	4-51
4.7 Synchronous control monitor data .....	4-56
4.8 Phase compensation function .....	4-61
4.9 Output axis sub functions .....	4-64

<b>5. Synchronous Control Initial Position</b>	<b>5- 1 to 5-34</b>
--	---------------------

5.1 Synchronous control initial position .....	5- 2
5.2 Synchronous control initial position parameters .....	5- 7
5.3 Cam axis position restoration method .....	5-11
5.3.1 Cam axis current value per cycle restoration .....	5-11
5.3.2 Cam reference position restoration .....	5-17
5.3.3 Cam axis feed current value restoration .....	5-19
5.4 Synchronous control analysis mode .....	5-22
5.5 Cam position calculation function .....	5-24
5.5.1 Cam position calculation control data .....	5-25
5.5.2 Cam position calculation monitor data .....	5-27
5.6 Method to restart synchronous control .....	5-33

<b>6. Troubleshooting (Synchronous Control)</b>	<b>6- 1 to 6-16</b>
---	---------------------

6.1 Error and warning details .....	6- 2
6.2 Error and warning of input axis .....	6- 3
6.2.1 List of input axis errors .....	6- 4

6.2.2 List of input axis warnings .....	6- 6
6.3 Error and warning of output axis.....	6- 7
6.3.1 List of output axis errors.....	6- 7
6.3.2 List of output axis warnings.....	6-11
6.4 Warning of cam operation.....	6-12
6.4.1 List of cam data operation warnings.....	6-12
6.4.2 List of cam auto-generation warnings .....	6-14
6.4.3 List of cam position calculation warnings .....	6-15

Appendices	Appendix- 1 to Appendix-20
------------	----------------------------

Appendix 1 Comparisons with the Motion controller SV22 .....	Appendix- 2
Appendix 2 Sample program of synchronous control .....	Appendix- 6
Appendix 3 Lists of buffer memory addresses for synchronous control .....	Appendix-10

## COMPLIANCE WITH THE EMC AND LOW VOLTAGE DIRECTIVES

### (1) For programmable controller system

To ensure that Mitsubishi programmable controllers maintain EMC and Low Voltage Directives when incorporated into other machinery or equipment, certain measures may be necessary. Please refer to one of the following manuals.

- QCPU User's Manual (Hardware Design, Maintenance and Inspection)
- MELSEC-L CPU Module User's Manual (Hardware Design, Maintenance and Inspection)
- Safety Guidelines

(This manual is included with the CPU module or base unit.)

The CE mark on the side of the programmable controller indicates compliance with EMC and Low Voltage Directives.

### (2) For the product

To make this product comply with EMC and Low Voltage Directives, refer to Section 4.3.1 "Precautions for wiring" of the following.

- "MELSEC-Q QD77MS Simple Motion Module User's Manual (Positioning Control)"
- "MELSEC-Q QD77GF Simple Motion Module User's Manual (Positioning Control)"
- "MELSEC-L LD77MS Simple Motion Module User's Manual (Positioning Control)"
- "MELSEC-L LD77MH Simple Motion Module User's Manual (Positioning Control)"

RELEVANT MANUALS

(1) Simple Motion module

Manual Name <Manual number (model code)>	Description
MELSEC-Q QD77MS Simple Motion Module User's Manual (Positioning Control)  <IB-0300185, 1XB947>	Specifications of the QD77MS and information on how to establish a system, maintenance and inspection, and troubleshooting  Functions, programming and buffer memory for the positioning control of the QD77MS
MELSEC-Q QD77GF Simple Motion Module User's Manual (Positioning Control)  <IB-0300202, 1XB956>	Specifications of the QD77GF and information on how to establish a system, maintenance and inspection, and troubleshooting  Functions, programming and buffer memory for the positioning control of the QD77GF
MELSEC-Q QD77GF Simple Motion Module User's Manual (Network)  <IB-0300203, 1XB957>	Overview of CC-Link IE Field Network, and specifications, procedures before operation, system configuration, installation, wiring, settings, functions, programming, and troubleshooting of the MELSEC-Q series Simple Motion module
MELSEC-L LD77MS Simple Motion Module User's Manual (Positioning Control)  <IB-0300211, 1XB961>	Specifications of the LD77MS and information on how to establish a system, maintenance and inspection, and troubleshooting  Functions, programming and buffer memory for the positioning control of the LD77MS
MELSEC-L LD77MH Simple Motion Module User's Manual (Positioning Control)  <IB-0300172, 1XB942>	Specifications of the LD77MH and information on how to establish a system, maintenance and inspection, and troubleshooting  Functions, programming and buffer memory for the positioning control of the LD77MH
MELSEC-Q/L QD77MS/QD77GF/LD77MS/LD77MH Simple Motion Module User's Manual (Synchronous Control)  <IB-0300174, 1XB943>	Functions, programming and buffer memory for the synchronous control of the Simple Motion module

## (2) CPU module

Manual Name <Manual number (model code)>	Description
QCPU User's Manual (Hardware Design, Maintenance and Inspection) <SH-080483ENG, 13JR73>	Specifications of the hardware (CPU modules, power supply modules, base units, batteries, and memory cards), system maintenance and inspection, and troubleshooting
QnUCPU User's Manual (Function Explanation, Program Fundamentals) <SH-080807ENG, 13JZ27>	Functions, devices, and programming of the CPU module
Qn(H)/QnPH/QnPRHCPU User's Manual (Function Explanation, Program Fundamentals) <SH-080808ENG, 13JZ28>	Functions, devices, and programming of the CPU module
MELSEC-L CPU Module User's Manual (Hardware Design, Maintenance and Inspection) <SH-080890ENG, 13JZ36>	Specifications of the CPU modules, power supply modules, display unit, SD memory cards, and batteries, information on how to establish a system, maintenance and inspection, and troubleshooting
MELSEC-L CPU Module User's Manual (Function Explanation, Program Fundamentals) <SH-080889ENG, 13JZ35>	Functions, devices, and programming of the CPU module

## (3) Programming tool

Manual Name <Manual number (model code)>	Description
GX Works2 Version1 Operating Manual (Common) <SH-080779ENG, 13JU63>	System configuration, parameter settings, and online operations (common to Simple project and Structured project) of GX Works2
GX Works2 Version1 Operating Manual (Intelligent Function Module) <SH-080921ENG, 13JU69>	Parameter settings, monitoring, and operations of the predefined protocol support function of intelligent function modules, using GX Works2
GX Developer Version 8 Operating Manual <SH-080373E, 13JU41>	Operating methods of GX Developer, such as programming, printing, monitoring, and debugging
GX Configurator-QP Version 2 Operating Manual <SH-080172, 13JU19>	Data creation (such as parameters and positioning data) and operations of transferring data to modules, positioning monitor, and tests using GX Configurator-QP (sold separately) *1

\*1: The manual is included in the CD-ROM of the software package in a PDF-format file.

For users interested in buying the manual separately, a printed version is available. Please contact us with the manual number (model code) in the list above.



#### (4) Servo amplifier

Manual Name <Manual number (model code)>	Description
SSCNETⅢ/H Interface AC Servo MR-J4-_B_(-RJ) Servo Amplifier Instruction Manual <SH-030106, 1CW805>	This manual explains the I/O signals, parts names, parameters, start-up procedure and others for MR-J4-_B_(-RJ) servo amplifier.
SSCNETⅢ/H Interface Multi-axis AC Servo MR-J4W2-_B_/MR-J4W3-_B_/MR-J4W2-0303B6 Servo Amplifier Instruction Manual <SH-030105, 1CW806>	This manual explains the I/O signals, parts names, parameters, start-up procedure and others for multi-axis AC servo MR-J4W2-_B_/MR-J4W3-_B_/MR-J4W2-0303B6 servo amplifier.
SSCNETⅢ Interface MR-J3-_B_ Servo Amplifier Instruction Manual <SH-030051, 1CW202>	This manual explains the I/O signals, parts names, parameters, start-up procedure and others for MR-J3-_B_ servo amplifier.
SSCNETⅢ Compatible Linear Servo MR-J3-_B_-RJ004(U_) Instruction Manual <SH-030054, 1CW943>	This manual explains the I/O signals, parts names, parameters, start-up procedure and others for linear servo MR-J3-_B_-RJ004(U_).
SSCNETⅢ Fully Closed Loop Control MR-J3-_B_-RJ006 Servo Amplifier Instruction Manual <SH-030056, 1CW304>	This manual explains the I/O signals, parts names, parameters, start-up procedure and others for fully closed loop control MR-J3-_B_-RJ006 servo amplifier.
SSCNETⅢ Interface 2-axis AC Servo Amplifier MR-J3W-0303BN6/MR-J3W-_B_ Servo Amplifier Instruction Manual <SH-030073, 1CW604>	This manual explains the I/O signals, parts names, parameters, start-up procedure and others for 2-axis AC servo amplifier MR-J3W-0303BN6/MR-J3W-_B_ servo amplifier.
SSCNETⅢ Interface Direct Drive Servo MR-J3-_B_-RJ080W Instruction Manual <SH-030079, 1CW601>	This manual explains the I/O signals, parts names, parameters, start-up procedure and others for direct drive servo MR-J3-_B_-RJ080W.
SSCNETⅢ Interface Drive Safety Integrated MR-J3-_B_ Safety Servo Amplifier Instruction Manual <SH-030084, ---- >	This manual explains the I/O signals, parts names, parameters, start-up procedure and others for safety integrated MR-J3-_B_ safety servo amplifier.
CC-Link IE Field Network Interface with Motion MR-J4-_B_-RJ010/MR-J4-_B4_-RJ010/MR-J3-T10 Servo Amplifier Instruction Manual <SH-030117, 1CW810>	This manual explains the I/O signals, parts names, parameters, start-up procedure and others for CC-Link IE Field Network interface AC servo amplifier with Motion MR-J4-_B_-RJ010/MR-J4-_B4_-RJ010 and CC-Link IE Field Network interface unit MR-J3-T10.
SSCNETⅢ/H Interface AC Servo MR-JE-_B_ Servo Amplifier Instruction Manual <SH-030152-A, 1CW750>	This manual explains the I/O signals, parts names, parameters, start-up procedure and others for MR-JE-_B_ servo amplifier.
SSCNETⅢ/H Interface AC Servo With Functional Safety MR-JE-_BF_ Servo Amplifier Instruction Manual <SH-030258, ---- >	This manual explains the I/O signals, parts names, parameters, start-up procedure and others for functional safety MR-JE-_BF_ servo amplifier.

Manual Name <Manual number (model code)>	Description
CC-Link IE Field Network Interface MR-J4-_GF_(-RJ) Servo Amplifier Instruction Manual (Motion Mode) <SH-030218, 1CW861>	This manual explains the I/O signals, parts names, parameters, start-up procedure and others for CC-Link IE Field Network interface AC servo amplifier with MR-J4-_GF_(-RJ).
CC-Link IE Field Network Interface MR-J4-_GF_(-RJ) Servo Amplifier Instruction Manual (I/O Mode) <SH-030221, 1CW863>	This manual explains the parameters for point table operation, start-up procedure and others for CC-Link IE Field Network interface AC servo amplifier with MR-J4-_GF_(-RJ).

MANUAL PAGE ORGANIZATION

■ The symbols used in this manual are shown below.

- A serial No. is inserted in the "\*" mark.

Symbol	Description
[Pr. * ]	Symbol that indicates positioning parameter and HPR parameter item.
[Da. * ]	Symbol that indicates positioning data, block start data and condition data item.
[Md. * ]	Symbol that indicates monitor data item.
[Cd. * ]	Symbol that indicates control data item.
<b>QD77MS</b>	Symbol that indicates correspondence to only QD77MS.
<b>LD77MS</b>	Symbol that indicates correspondence to only LD77MS.
<b>QD77GF</b>	Symbol that indicates correspondence to only QD77GF.
[RJ010 mode]	Symbol that indicates specifications during the communication mode compatible with MR-J4-B-RJ010. This mode corresponds to the MR-J4-_B_-RJ010+MR-J3-T10 servo amplifier. When using the virtual servo amplifier function, it operates in MR-J4-B-RJ010 communication mode regardless of the communication mode setting.
[CiA402 mode]	Symbol that indicates specifications during the communication mode compatible with CiA402. This mode corresponds to the MR-J4-_GF_(-RJ) servo amplifier and others.

■ Representation of numerical values used in this manual.

- Buffer memory addresses, error codes and warning codes are represented in decimal.
- X/Y devices are represented in hexadecimal.
- Setting data and monitor data are represented in decimal or hexadecimal. Data ended by "H" or "h" is represented in hexadecimal.

(Example) 10.....Decimal

10H.....Hexadecimal

■ Representation of buffer memory address used in this manual.

In the buffer memory address, "n" in "32800+10n", etc. indicates a value corresponding to axis No. such as the following table.

Axis No.	n	Axis No.	n	Axis No.	n	Axis No.	n
1	0	5	4	9	8	13	12
2	1	6	5	10	9	14	13
3	2	7	6	11	10	15	14
4	3	8	7	12	11	16	15

(Note-1): Calculate as follows for the buffer memory address corresponding to each axis.

(Example) For axis No. 16

$$32800+10n \text{ ([Pr.300] Servo input axis type)}=32800+10 \times 15=32950$$

(Note-2): The range from axis No.1 to 2 (n=0 to 1) is valid in the 2-axis module, the range from axis No.1 to 4 (n=0 to 3) is valid in the 4-axis module, and the range from axis No.1 to 8 (n=0 to 7) is valid in the 8-axis module.

In the buffer memory address, "j" in "34720+20j", etc. indicates a value corresponding to synchronous encoder axis No. such as the following table.

Synchronous encoder axis No.	j
1	0
2	1
3	2
4	3

(Note-1): Calculate as follows for the buffer memory address corresponding to each axis.

(Example) For synchronous encoder axis No. 4

$$34720+20j \text{ ([Pr.320] Synchronous encoder axis type)}=34720+20 \times 3=34780$$

## TERMS

Unless otherwise specified, this manual uses the following terms.

Term	Description
PLC CPU	The abbreviation for the MELSEC-Q/L series PLC CPU module
QCPU	Another term for the MELSEC-Q series PLC CPU module
Simple Motion module	The abbreviation for the MELSEC-Q/MELSEC-L series Simple Motion module
QD77MS	Another term for the MELSEC-Q series Simple Motion module
QD77GF	
LD77MS	Another term for the MELSEC-L series Simple Motion module
LD77MH	
MR-J4(W)-B	MR-J4-_B_(-RJ)/MR-J4W_-_B/MR-J4-_B_-RJ010+MR-J3-T10 Servo amplifier series
MR-J3(W)-B	MR-J3-_B_(-RJ)/MR-J3W-_B Servo amplifier series
MR-J4-GF	MR-J4-_GF_(-RJ) Servo amplifier series
MR-J4-B-RJ	MR-J4-_B_-RJ Servo amplifier series
MR-J4-GF-RJ	MR-J4-_GF_-RJ Servo amplifier series
MR-JE-B(F)	MR-JE-_B_(F) Servo amplifier series
Programming tool	A generic term for GX Works2, GX Developer and MR Configurator2
GX Works2	The product name of the software package for the MELSEC programmable controllers (Version 1.31H or later)
MR Configurator2	The product name of the setup software for the servo amplifier (Version 1.01B or later)
GX Developer	The product name of the software package for the MELSEC programmable controllers (Version 8.89T or later)
GX Configurator-QP	The product name of the setting and monitoring tool for the Simple Motion module (Version 2.34L or later)
Intelligent function module	A MELSEC-Q/L series module that has functions other than input or output, such as A/D converter module and D/A converter module
Servo amplifier	A generic term for a drive unit Unless specified in particular, indicates the motor driver unit of the sequential command method which is controlled by the Simple Motion module (belonging to own station).
Axis	Another term for a servo amplifier
HPR	A generic term for "Home position return"
HP	A generic term for "Home position"
SSCNET III/H (Note)	High speed synchronous communication network between QD77MS/LD77MS/LD77MH and servo amplifier
SSCNET III (Note)	
CC-Link IE Field Network	A high-speed and large-capacity open field network that is based on Ethernet (1000BASE-T)
2-axis module	A generic term for QD77MS2 and LD77MS2
4-axis module	A generic term for QD77MS4, QD77GF4, LD77MS4, and LD77MH4
8-axis module	Another term for QD77GF8
16-axis module	A generic term for QD77MS16, QD77GF16, LD77MS16 and LD77MH16

(Note): SSCNET: Servo System Controller NETwork

PACKING LIST

The following items are included in the package of each product. Before use, check that all the items are included.

■ QD77MS

(1) QD77MS2

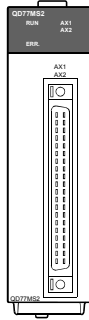

QD77MS2



Before Using the Product

(2) QD77MS4

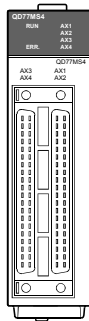

QD77MS4



Before Using the Product

(3) QD77MS16

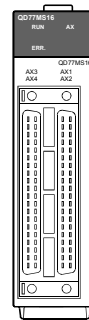

QD77MS16



Before Using the Product

■ QD77GF

(1) QD77GF4



QD77GF4



Before Using the Product

(2) QD77GF8

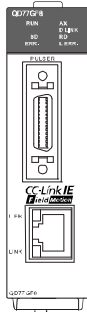

QD77GF8



Before Using the Product

(3) QD77GF16

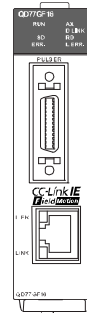

QD77GF16

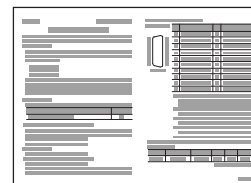

Before Using the Product

■ LD77MS

(1) LD77MS2

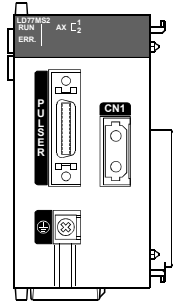

LD77MS2

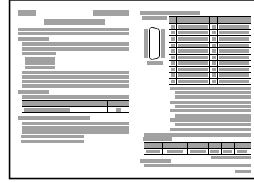

Before Using the Product

(2) LD77MS4

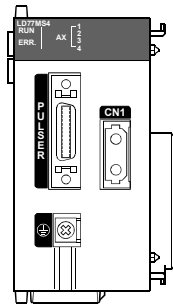

LD77MS4

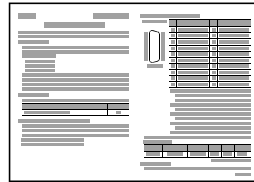

Before Using the Product

(3) LD77MS16

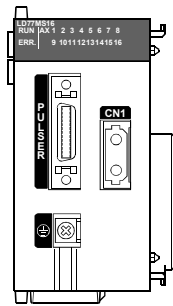

LD77MS16



Before Using the Product



■ LD77MH

(1) LD77MH4

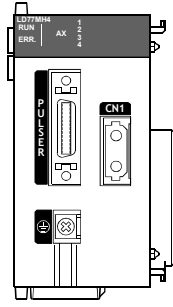

LD77MH4

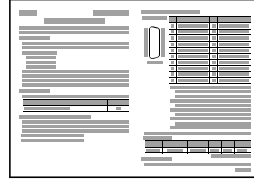

Before Using the Product

(2) LD77MH16

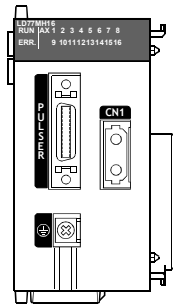

LD77MH16

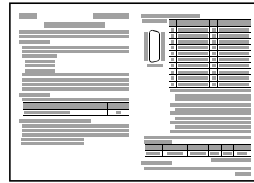

Before Using the Product



# Chapter 1 Outline of Synchronous Control

The outline, specifications and the operation method of synchronous control using the Simple Motion module are explained in this chapter.

This chapter helps to understand what can be done using the positioning system and which procedure to use for a specific purpose.

1.1	Outline of synchronous control .....	1- 2
1.2	Performance specifications .....	1- 6
1.3	Restrictions by the SERIAL No. and version .....	1- 9
1.4	Operation method of synchronous control .....	1-11
1.4.1	Synchronous control execution procedure .....	1-11
1.4.2	Starting/ending for synchronous control .....	1-12
1.4.3	Stop operation of output axis .....	1-14

## 1.1 Outline of synchronous control

"Synchronous control" can be achieved using software instead of controlling mechanically with gear, shaft, speed change gear or cam, etc.

"Synchronous control" synchronizes movement with the input axis (servo input axis, command generation axis or synchronous encoder axis), by setting "the parameters for synchronous control" and starting synchronous control on each output axis.

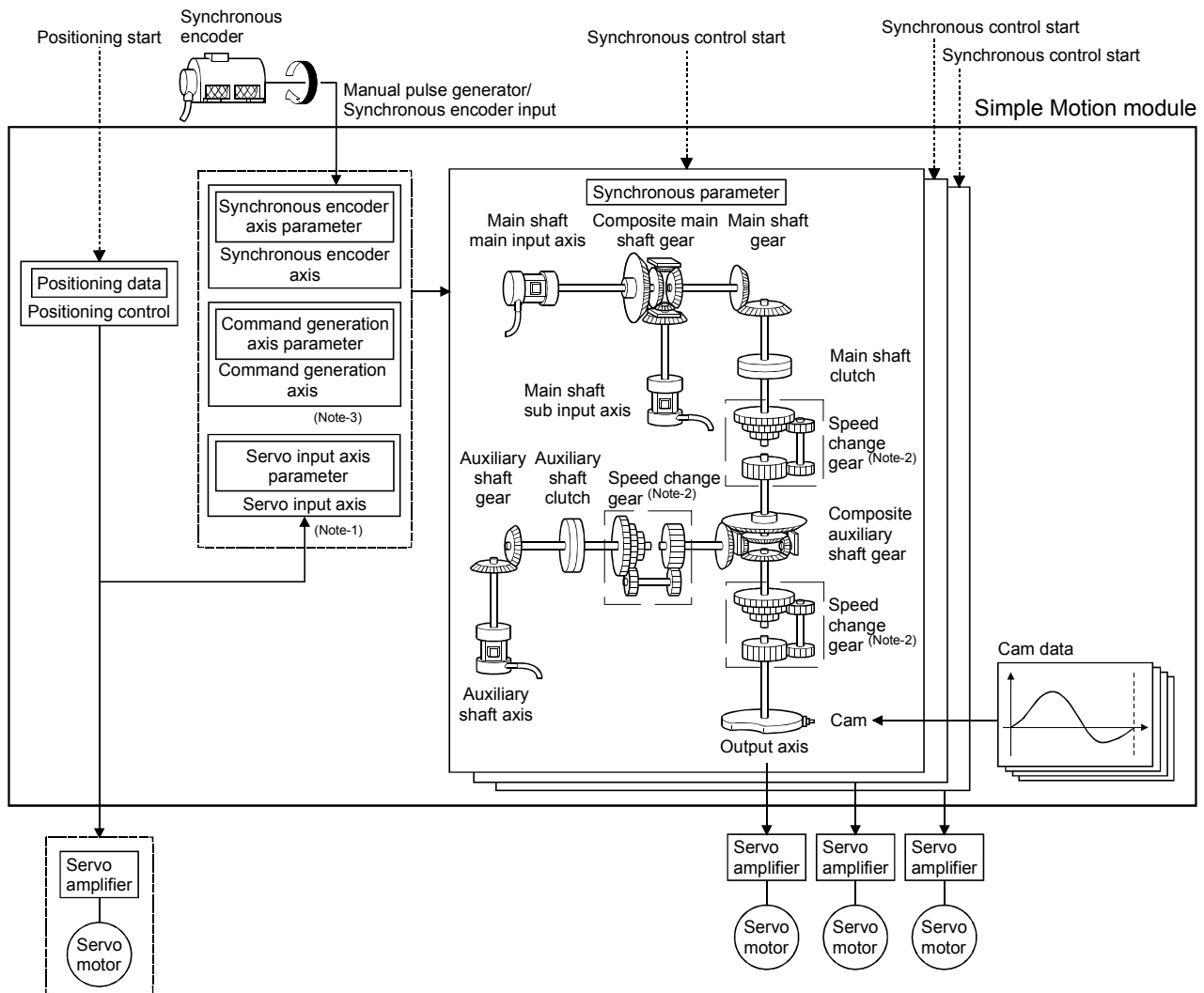

It is possible to control without amplifier by setting the virtual servo amplifier.

(Note-1): It is possible to drive the servo input axis except for the positioning control (HPR, manual control, speed-torque control, synchronous control). Refer to the "User's Manual (Positioning control)" of each Simple Motion module for details on the positioning control, HPR, the manual control and the speed-torque control. (For QD77GF, it is not available to switch to "Continuous operation to torque control mode" of speed-torque control.)

(Note-2): Speed change gear can be arranged on one of "Main shaft side", "Auxiliary shaft side" or "After composite auxiliary shaft gear".

(Note-3): For the drive method of the command generation axis, refer to Section 2.2 "Command generation axis".

■ List of synchronous control module

The module is used in synchronous control as follows.

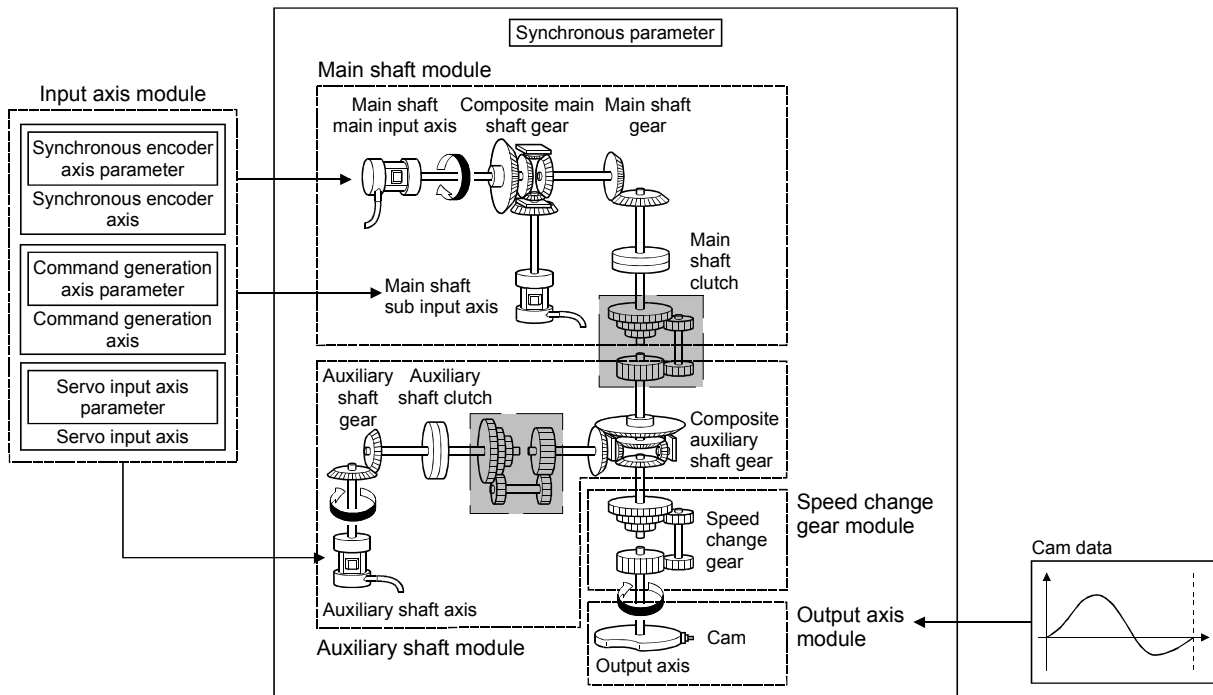





**POINT**





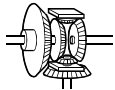

- (1) Input axis module can be set to one of servo input axis, command generation axis or synchronous encoder axis.
- (2) Speed change gear can be arranged on one of main shaft side, auxiliary shaft side or after composite auxiliary shaft gear.
- (3) Set the travel value of input axis module as large as possible to prevent the speed fluctuation of output axis module in the synchronous control. If the travel value of input axis module is small, the speed fluctuation of output axis module may occur depending on the setting for synchronous parameter.
- (4) The following items can be monitored in the synchronous control image screen using the Simple Motion Module Setting Tool; each synchronous control monitor data and the rotation direction of main shaft main input axis, main shaft sub input axis, auxiliary shaft axis, and output axis (cam axis feed current value)

(1) Input axis

Classification	Name	Parts	Function description	Maximum number of usable					Reference
				Number per module				Number per axis	
				2-axis module	4-axis module	8-axis module	16-axis module		
Input axis module	Servo input axis	—	<ul style="list-style-type: none"> <li>Used to drive the input axis with the position of the servomotor controlled by the Simple Motion module.</li> </ul>	2	4	8	16	—	Section 2.1
	Command generation axis	—	<ul style="list-style-type: none"> <li>Used to drive the input axis by generating only the positioning command based on the positioning data of the command generation axis.</li> </ul>	2	4	—	8	—	Section 2.2
	Synchronous encoder axis	—	<ul style="list-style-type: none"> <li>Used to drive the input axis with input pulse from the synchronous encoder.</li> </ul>	4				—	Section 2.3

(2) Output axis

Classification	Name	Parts	Function description	Maximum number of usable					Reference
				Number per module				Number per axis	
				2-axis module	4-axis module	8-axis module	16-axis module		
Main shaft module	Main shaft main input axis		<ul style="list-style-type: none"> <li>The input axis on the main side of the main shaft module.</li> <li>The reference position on the main shaft.</li> </ul>	2	4	8	16	1	Section 4.1
	Main shaft sub input axis		<ul style="list-style-type: none"> <li>The input axis on the sub side of the main shaft module.</li> <li>It is used to compensate for the position of the main shaft main input axis.</li> </ul>	2	4	8	16	1	Section 4.1
	Composite main shaft gear		<ul style="list-style-type: none"> <li>The composite travel value of the main shaft main input axis and the main shaft sub input axis are transmitted to the main shaft gear.</li> </ul>	2	4	8	16	1	Section 4.1
	Main shaft gear		<ul style="list-style-type: none"> <li>The converting travel value after composite main shaft gear is transmitted by the setting gear ratio.</li> </ul>	2	4	8	16	1	Section 4.1
	Main shaft clutch		<ul style="list-style-type: none"> <li>The main shaft travel value is transmitted by the clutch ON/OFF.</li> </ul>	2	4	8	16	1	Section 4.1 Section 4.3

Classification	Name	Parts	Function description	Maximum number of usable					Reference
				Number per module				Number per axis	
				2-axis module	4-axis module	8-axis module	16-axis module		
Auxiliary shaft module	Auxiliary shaft axis		<ul style="list-style-type: none"> <li>The input axis of the auxiliary shaft module.</li> </ul>	2	4	8	16	1	Section 4.2
	Auxiliary shaft gear		<ul style="list-style-type: none"> <li>The converting auxiliary shaft travel value is transmitted by the setting gear ratio.</li> </ul>	2	4	8	16	1	Section 4.2
	Auxiliary shaft clutch		<ul style="list-style-type: none"> <li>The auxiliary shaft travel value is transmitted by the clutch ON/OFF.</li> </ul>	2	4	8	16	1	Section 4.2 Section 4.3
	Composite auxiliary shaft gear		<ul style="list-style-type: none"> <li>The composite travel value of the main shaft and the auxiliary shaft are transmitted.</li> </ul>	2	4	8	16	1	Section 4.2
Speed change gear module	Speed change gear		<ul style="list-style-type: none"> <li>It is used to change the speed by setting speed change ratio during the operation.</li> </ul>	2	4	8	16	1	Section 4.4
Output axis module	Output axis		<ul style="list-style-type: none"> <li>The cam conversion is processed based on the input travel value and the setting cam data.</li> <li>The feed current value is output as the command to the servo amplifier.</li> </ul>	2	4	8	16	1	Section 4.5

(3) Cam data

Classification	Name	Function description	Maximum number of usable	Reference
			Number per module	
Cam data	Cam data	<ul style="list-style-type: none"> <li>It controls the operation pattern of the output axis (two-way operation and feed operation), which is corresponding to the input travel value of the output axis module.</li> </ul>	Up to 256	Chapter 3

## 1.2 Performance specifications

## ■ Performance specifications

Item		Number of settable axes			
		2-axis module	4-axis module	8-axis module	16-axis module
Input axis	Servo input axis	2 axes/module	4 axes/module	8 axes/module	16 axes/module
	Command generation axis QD77MS LD77MS	2 axes/module	4 axes/module	—	8 axes/module
	Synchronous encoder axis	4 axes/module			
Composite main shaft gear		1/output axis			
Main shaft main input axis		1 axis/output axis			
Main shaft sub input axis		1 axis/output axis			
Main shaft gear		1/output axis			
Main shaft clutch		1/output axis			
Auxiliary shaft		1 axis/output axis			
Auxiliary shaft gear		1/output axis			
Auxiliary shaft clutch		1/output axis			
Composite auxiliary shaft gear		1/output axis			
Speed change gear		1/output axis			
Output axis (Cam axis)		2 axes/module	4 axes/module	8 axes/module	16 axes/module



■ Cam specifications

Item		Specification	
Memory capacity	Cam storage area	256k bytes	
	Cam open area	1024k bytes	
Number of cam registration <sup>(Note-1)</sup>		Up to 256 (Dependent on memory capacity, cam resolution and coordinate number)	
Comment		Up to 32 characters per cam data	
Cam data	Stroke ratio data format	Cam resolution	256/512/1024/2048/4096/8192/16384/32768
		Stroke ratio	-214.7483648 to 214.7483647[%]
	Coordinate data format	Coordinate number	2 to 16384
		Coordinate data	Input value: 0 to 2147483647 Output value: -2147483648 to 2147483647

(Note-1): The maximum number of cam registration by the cam resolution is shown below. (In case it created by the same cam resolution.)

(1) Stroke ratio data format

Cam resolution	Maximum number of cam registration	
	Cam storage area	Cam open area
256	256	256
512	128	256
1024	64	256
2048	32	128
4096	16	64
8192	8	32
16384	4	16
32768	2	8

(2) Coordinate data format

Coordinate number	Maximum number of cam registration	
	Cam storage area	Cam open area
128	256	256
256	128	256
512	64	256
1024	32	128
2048	16	64
4096	8	32
8192	4	16
16384	2	8

### ■ Cam operation specifications

Item	Specification
Operation method of cam data	(1) GX Works2 Write/read/verify to cam storage area (2) Via buffer memory (Cam data operation function) Write/read to cam storage area and cam open area
Cam auto-generation function	Automatically generate the cam for rotary cutter.
Cam position calculation function	Calculate the cam position by the program. Used to calculate the cam position for the synchronous control initial position before starting synchronous control.

### ■ Synchronous encoder axis specifications

Item	Specification
Number of control axes	4
Synchronous encoder axis type	Incremental synchronous encoder/ Synchronous encoder via servo amplifier <b>QD77MS</b> <b>LD77MS</b> <b>QD77GF</b> [CiA402 mode]/ Synchronous encoder via CPU
Control unit	mm, inch, degree, PLS (Possible to select the decimal places of position unit and speed unit)
Unit conversion	Numerator -2147483648 to 2147483647 [Synchronous encoder axis position unit]
	Denominator 1 to 2147483647 [PLS]
Length per cycle setting range	1 to 2147483647 [Synchronous encoder axis position unit]
Current value range	Current value -2147483648 to 2147483647 [Synchronous encoder axis position unit]
	Current value per cycle 0 to (Length per cycle - 1) [Synchronous encoder axis position unit]
Control method	Control instruction Current value change, Counter disable, Counter enable
	Current value setting address Address setting range: -2147483648 to 2147483647 [Synchronous encoder axis position unit]

### 1.3 Restrictions by the SERIAL No. and version

Software versions that are compatible with each Simple Motion module are shown below.

	Version	
	GX Works2	MR Configurator2
QD77MS	Version 1.77F or later	Version 1.09K or later
QD77GF	Version 1.98C or later	Version 1.19V or later
LD77MS	Version 1.493P or later	Version 1.20W or later
LD77MH	Version 1.31H or later	Version 1.01B or later

There are restrictions in the function that can be used by the SERIAL No. of the Simple Motion module and the version of GX Works2.

The combination of each version and function are shown below.

#### (1) QD77MS

Function	QD77MS2/QD77MS4/QD77MS16		Reference
	First five digits of SERIAL No. (Note-1)	GX Works2	
Synchronous encoder via servo amplifier	15042 or later	1.492N or later	Section 2.3
Command generation axis	19032 or later	1.565P or later	Section 2.2

(Note-1): The serial number can be checked on the "Product Information List" screen in GX Works2.

#### (2) QD77GF

Function	QD77GF4/QD77GF8/QD77GF16		Reference
	First five digits of SERIAL No. (Note-1)	GX Works2	
Synchronous encoder via servo amplifier	18022 or later	Scheduled to be 1.545T or later	Section 2.3

(Note-1): The serial number can be checked on the "Product Information List" screen in GX Works2.

#### (3) LD77MS

Function	LD77MS2/LD77MS4/LD77MS16		Reference
	First five digits of SERIAL No. (Note-1)	GX Works2	
Command generation axis	19032 or later	1.565P or later	Section 2.2

(Note-1): The serial number can be checked on the "Product Information List" screen in GX Works2.

## (4) LD77MH

Function	LD77MH4		LD77MH16		Reference
	First five digits of SERIAL No. (Note-1)	GX Works2	First five digits of SERIAL No. (Note-1)	GX Works2	
Clutch function	12102 or later	1.48A or later	—	1.48A or later	Section 4.1 Section 4.2 Section 4.3
Auxiliary shaft	12102 or later	1.48A or later	—	1.48A or later	Section 4.2
Cam function using coordinate data format	12102 or later	1.48A or later	—	1.48A or later	Chapter 3
Expand capacity of cam storage area (16k bytes to 256k bytes)	12102 or later	1.48A or later	—	1.48A or later	Section 1.2
Synchronous control change function	12102 or later	1.48A or later	—	1.48A or later	Section 4.6
Synchronous encoder: 4 axes	12102 or later	1.48A or later	—	1.48A or later	Section 2.3
Synchronous encoder via CPU	12102 or later	1.48A or later	—	1.48A or later	Section 2.3
Synchronous encoder control by high speed input request	12102 or later	1.48A or later	—	1.48A or later	Section 2.3
Output axis smoothing function	12102 or later	1.48A or later	12102 or later	1.48A or later	Section 4.5
Cam axis current value per cycle movement function	12102 or later	—	12102 or later	—	Section 4.6

—: No restriction by the version.

(Note-1): The serial number can be checked on the "Product Information List" screen in GX Works2.

Refer to the following for how to check the SERIAL No. of the Simple Motion module.

- QD77MS : "MELSEC-Q QD77MS Simple Motion Module User's Manual (Positioning Control)"
- QD77GF : "MELSEC-Q QD77GF Simple Motion Module User's Manual (Positioning Control)"
- LD77MS : "MELSEC-L LD77MS Simple Motion Module User's Manual (Positioning Control)"
- LD77MH : "MELSEC-L CPU Module User's Manual (Hardware Design, Maintenance and Inspection)"

## 1.4 Operation method of synchronous control

### 1.4.1 Synchronous control execution procedure

The synchronous control is executed using the following procedure.

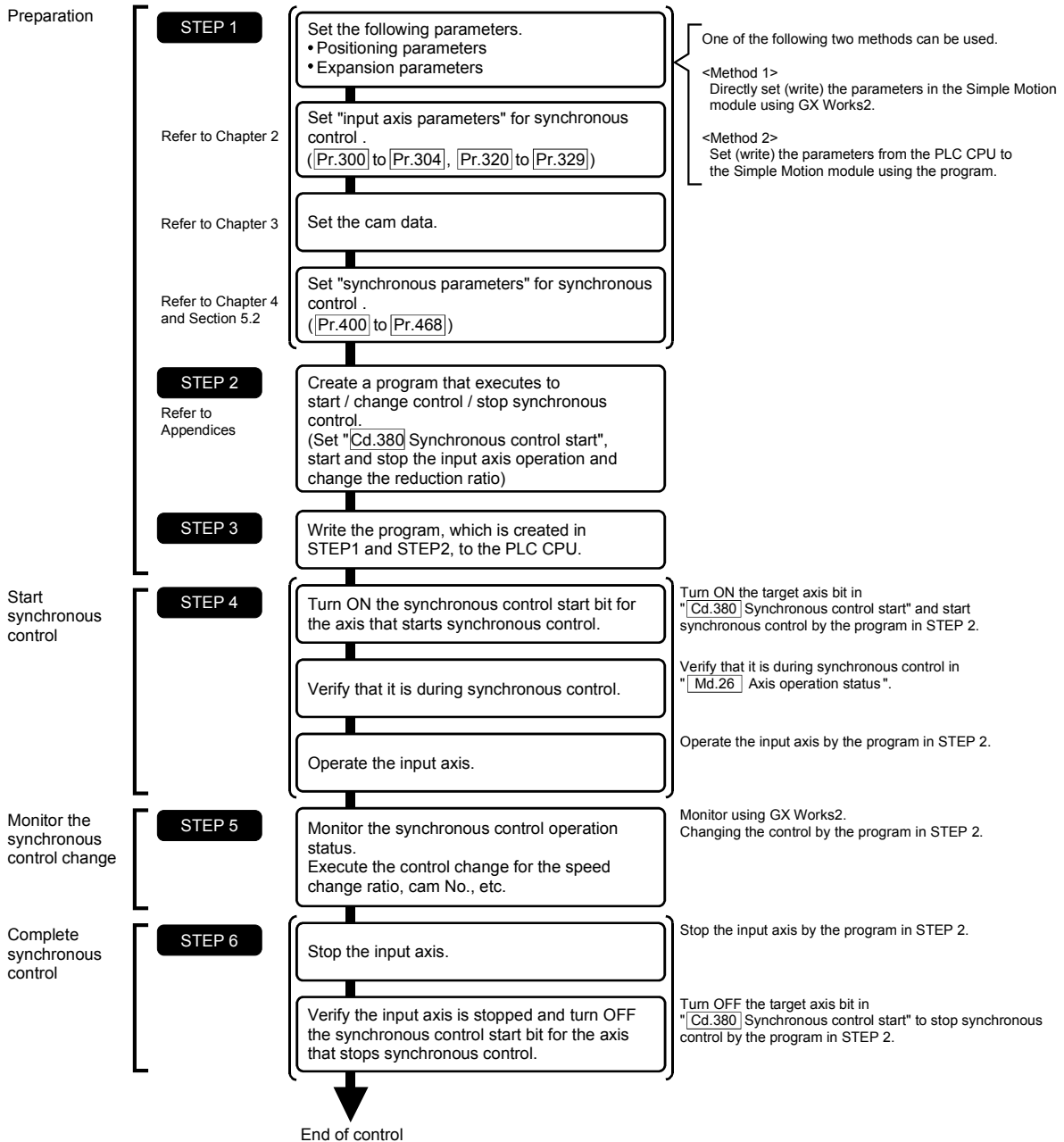

#### REMARK

- Mechanical elements such as limit switches are considered as already installed.
- Parameter settings for positioning control apply for all axes with the Simple Motion module.
- Be sure to execute the HPR when the HPR request flag is ON.

### 1.4.2 Starting/ending for synchronous control

Set the parameters for synchronous control for each output axis to start synchronous control. The status changes to synchronous control after the parameters are analyzed at the start of synchronous control, and the output axes synchronize with input axis operations.

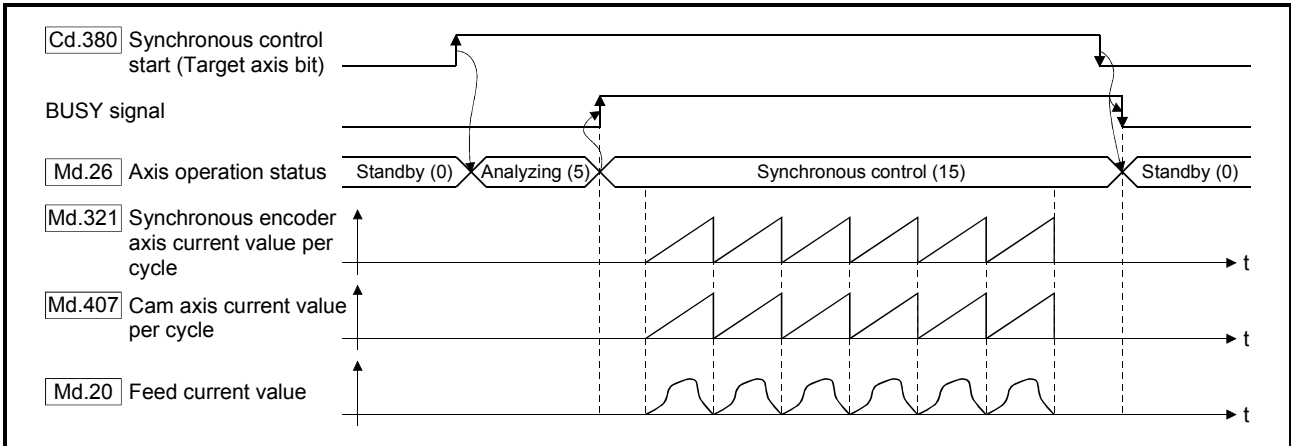

#### ■ Synchronous control system control data

Setting item	Setting details	Setting value	Default value	Buffer memory address
[Cd.380] Synchronous control start	<ul style="list-style-type: none"> <li>Synchronous control begins if the target axis bit is turned ON.</li> <li>Synchronous control ends if the bit is turned OFF during synchronous control.</li> </ul> Fetch cycle: Operation cycle	<ul style="list-style-type: none"> <li>Set the target axis in 16bits. (bit0: axis 1 to bit15: axis 16 (Note-1))</li> <li>OFF : Synchronous control end</li> <li>ON : Synchronous control start</li> </ul>	0	36320

(Note-1): The range from axis 1 to 2 is valid in the 2-axis module, from axis 1 to 4 is valid in the 4-axis module, from axis 1 to 8 is valid in the 8-axis module, and from axis 1 to 16 is valid in the 16-axis module.

#### ■ Starting method for synchronous control

Synchronous control can be started by turning the target axis bit from OFF to ON in "[Cd.380] Synchronous control start" after setting the parameters for synchronous control. "5: Analyzing" is set in "[Md.26] Axis operation status" at the synchronous control start, and the parameters for synchronous control are analyzed. The BUSY signal turns ON after completion of analysis, and "15: Synchronous control" is set in "[Md.26] Axis operation status".

Start the input axis operation after confirming that "15: Synchronous control" is set in "[Md.26] Axis operation status".

#### ■ Ending method for synchronous control

Synchronous control can be ended by turning the target axis bit from ON to OFF in "[Cd.380] Synchronous control start" after the input axis operation is stopped. The BUSY signal turns OFF at the synchronous control end, and "0: Standby" is set in "[Md.26] Axis operation status" at the output axis stop.

Synchronous control can also be ended by turning the target axis bit from ON to OFF in "[Cd.380] Synchronous control start" during the input axis operation. However, it is recommended to end after stopping the input axis operation since the output axis stops immediately.

Refer to Section 1.4.3 "Stop operation of output axis" at the synchronous control end.

■ Starting history

The starting history is updated when starting synchronous control. "9020: Synchronous control operation" is stored in "[Md.4] Start No."

■ Status when starting synchronous control

The following bits in "[Md.31] Status" are turned OFF when starting synchronous control in the same way as for the positioning control start.

- b0 : In speed control flag
- b1 : Speed-position switching latch flag
- b2 : Command in-position flag
- b4 : HPR complete flag
- b5 : Position-speed switching latch flag
- b10 : Speed change 0 flag

■ Restrictions

- (1) If bit for multiple axes are turned ON simultaneously in "[Cd.380] Synchronous control start", control is not started simultaneously since the analysis is processed for each axis in numerical order. When the multiple axes must be started simultaneously, start the input axis operation after confirming that all axes are configured for the synchronous control.
- (2) If the input axis operates during the analysis at the synchronous control start, the travel value of the input axis is reflected immediately after the synchronous control start. The output axis might rapidly accelerate depending on the travel value of the input axis. Start the input axis operation after confirming that are configured for synchronous control.
- (3) The analysis process for synchronous control start might take time depending on the parameter setting for synchronous control. (Up to about 10ms: In case of searching the cam (cam resolution: 32768) with the setting "0: Cam axis current value per cycle restoration" in "[Pr.462] Cam axis position restoration object".)  
Set "1: Cam reference position restoration" or "2: Cam axis feed current value restoration" in "[Pr.462] Cam axis position restoration object" to start synchronous control at high speed.
- (4) When the synchronous control parameter is set to the value outside the setting range, the synchronous control does not start, and the input axis error No. is stored in the monitor data.

### 1.4.3 Stop operation of output axis

If the following causes occur in stopping the output axis during synchronous control, synchronous control is completed after stops processing for the output axis (BUSY signal is OFF, axis operation status is standby).

Synchronous alignment must be executed for the output axis to restart the synchronous control. (Refer to Section 4.5)

Stop cause	Stop process
The target axis bit of "[Cd.380] Synchronous control start" is turned from ON to OFF.	Immediate stop
Software stroke limit error occurrence	
Forced stop	
Stop group1 to 3 <sup>(Note-1)</sup> (Stop with hardware stroke limit or stop command)	Deceleration stop

(Note-1): Refer to the "User's Manual (Positioning control)" of each Simple Motion module.

#### (1) Immediate stop

The operation stops without decelerate. The Simple Motion module immediately stops the command, but the operation will coast for the droop pulses accumulated in the deviation counter of the servo amplifier.

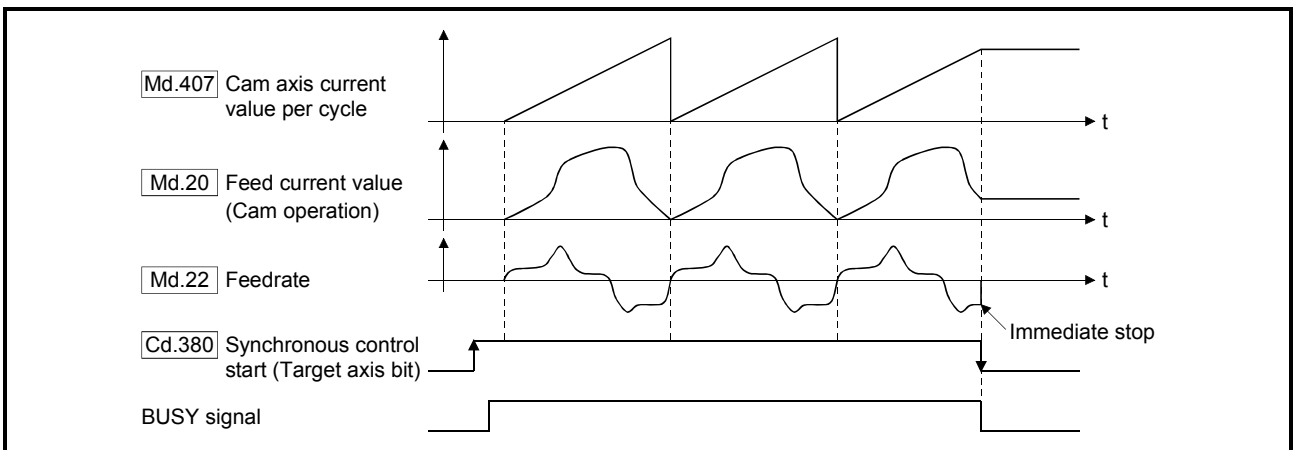



(2) Deceleration stop

The output axis stops with deceleration according to the setting in "[Pr.37] Stop group 1 rapid stop selection" to "[Pr.39] Stop group 3 rapid stop selection". The deceleration time is set in "[Pr.446] Synchronous control deceleration time" for deceleration stop, and in "[Pr.36] Rapid stop deceleration time" for rapid stop. The slope of deceleration is as follows.

$$\text{Slope of deceleration} = \frac{\text{"[Pr.8] Speed limit value"} \times \text{Deceleration time}}{\text{(Rapid stop deceleration time)}}$$

The cam axis current value per cycle is not updated, and only the feed current value is updated, since the deceleration stop begins. Therefore, the path of the feed current value is drawn regardless the cam operation with deceleration stop.

The input axis must be stopped when the output axis is stop synchronizing with the input axis.

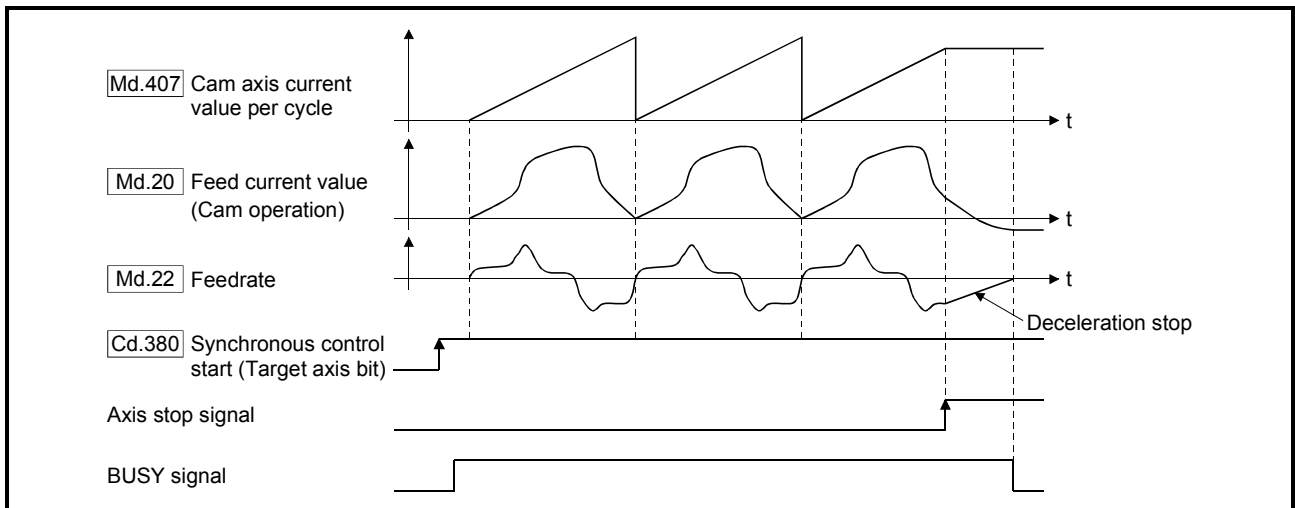



# Chapter 2 Input Axis Module

The settings for the parameter and monitor data for the input axis module that are used with synchronous control are explained in this chapter.

Refer to the "User's Manual (Positioning Control)" of each Simple Motion module for details on the connection and control for the servo amplifier and the synchronous encoder that is used for input axis module.

2.1	Servo input axis.....	2- 2
2.1.1	Overview of servo input axis .....	2- 2
2.1.2	Servo input axis parameters .....	2- 4
2.1.3	Servo input axis monitor data .....	2- 8
2.2	Command generation axis .....	2-10
2.2.1	Overview of command generation axis .....	2-10
2.2.2	Command generation axis parameters .....	2-15
2.2.3	Command generation axis control data .....	2-19
2.2.4	Command generation axis monitor data .....	2-24
2.2.5	Command generation axis positioning data.....	2-29
2.2.6	Write/read method for command generation axis parameter and positioning data .....	2-31
2.3	Synchronous encoder axis.....	2-35
2.3.1	Overview of synchronous encoder axis .....	2-35
2.3.2	Setting method for synchronous encoder .....	2-38
2.3.3	Synchronous encoder axis parameters .....	2-46
2.3.4	Synchronous encoder axis control data .....	2-54
2.3.5	Synchronous encoder axis monitor data .....	2-58

## 2.1 Servo input axis

### 2.1.1 Overview of servo input axis

The servo input axis is used to drive the input axis based on the position of the servomotor that is being controlled by the Simple Motion module.

The status of a servo input axis can also be monitored even before the synchronous control start since the setting of a servo input axis is valid after the system's power supply ON.

The following shows the relationship between the position of the servomotor and the servo input axis.

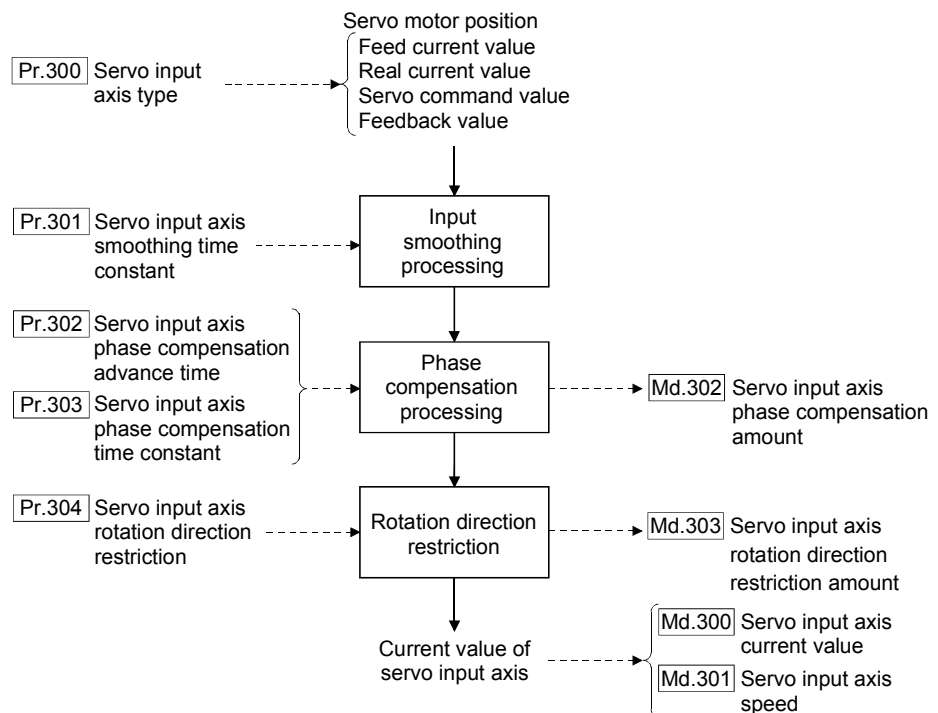

#### ■ Control method for servo input axis

All controls (including synchronous control) can be executed for a servo input axis.

Refer to the "User's Manual (Positioning Control)" of each Simple Motion module for the controls other than the synchronous control.

#### POINT

If the virtual servo amplifier function is set in the servo input axis, synchronous control can be executed by the input value as virtual.

Refer to the "User's Manual (Positioning Control)" of each Simple Motion module for details on virtual servo amplifier function.

### ■ Restrictions

If "1: Feed current value" or "2: Real current value" is set in "[Pr.300] Servo input axis type", set "1: Update feed current value" in "[Pr.21] Feed current value during speed control" to start the speed position change control. If "0: Do not update feed current value" or "2: Clear feed current value to zero" is set in [Pr.21], the error "Speed-position switching control start in servo input axis not possible" (error code: 609) will occur and the control will not start.

### ■ Units for the servo input axis

The position units and speed units for the servo input axis are shown below for the setting "[Pr.300] Servo input axis type" and "[Pr.1] Unit setting".

Table 2.1 Servo input axis position units

Setting value of "[Pr.300] Servo input axis type"	Setting value of "[Pr.1] Unit setting"	Servo input axis position unit	Range
1: Feed current value 2: Real current value	0: mm	$\times 10^{-4}$ mm ( $10^{-1}$ $\mu$ m)	-214748.3648 to 214748.3647 [mm] (-214748364.8 to 214748364.7 [ $\mu$ m])
	1: inch	$\times 10^{-5}$ inch	-21474.83648 to 21474.83647 [inch]
	2: degree	$\times 10^{-5}$ degree	-21474.83648 to 21474.83647 [degree]
	3: PLS	PLS	-2147483648 to 2147483647 [PLS]
3: Servo command value 4: Feedback value	—	PLS	-2147483648 to 2147483647 [PLS]

Table 2.2 Servo input axis speed units

Setting value of "[Pr.300] Servo input axis type"	Setting value of "[Pr.1] Unit setting"	Servo input axis speed unit	Range
1: Feed current 2: Real current value	0: mm	$\times 10^{-2}$ mm/min	-21474836.48 to 21474836.47 [mm/min]
	1: inch	$\times 10^{-3}$ inch/min	-2147483.648 to 2147483.647 [inch/min]
	2: degree	$\times 10^{-3}$ degree/min (Note-1)	-2147483.648 to 2147483.647 [degree/min] (Note-1)
	3: PLS	PLS/s	-2147483648 to 2147483647 [PLS/s]
3: Servo command value 4: Feedback value	—	PLS/s	-2147483648 to 2147483647 [PLS/s]

(Note-1): When "[Pr.83] Speed control 10 x multiplier setting for degree axis" is valid, this will be the speed unit " $\times 10^{-2}$  degree/min" (Range: -21474836.48 to 21474836.47 [degree/min]).

POINT
(1) When "1: Feed current value" or "3: Servo command value" is set in "[Pr.300] Servo input axis type", and the servo input axis becomes servo OFF by the servo alarm or forced stop, the amount of value change may be large. This can be prevented by setting "2: Real current value" or "4: Feedback value" in "[Pr.300] Servo input axis type".
(2) When a home position return for the axis where "1: Feed current value" or "2: Real current value" is set in "[Pr.300] Servo input axis type" is performed, if the servo input axis operation during home position return is used as the input value, the input is stopped in the midway of home position return. When the servo input axis operation during home position return is used as the input value, set "3: Servo command value" or "4: Feedback value" in "[Pr.300] Servo input axis type".

## 2.1.2 Servo input axis parameters

Setting item	Setting details	Setting value	Default value	Buffer memory address
[Pr.300] Servo input axis type	<ul style="list-style-type: none"> <li>Set the current value type to be generated of the input value for the servo input axis.</li> </ul> <u>Fetch cycle: At power supply ON</u>	<ul style="list-style-type: none"> <li>Set in decimal.</li> <li>0: Invalid</li> <li>1: Feed current value</li> <li>2: Real current value</li> <li>3: Servo command value</li> <li>4: Feedback value</li> </ul>	0	32800+10n
[Pr.301] Servo input axis smoothing time constant	<ul style="list-style-type: none"> <li>Set to smooth the input value.</li> </ul> <u>Fetch cycle: At power supply ON</u>	<ul style="list-style-type: none"> <li>Set in decimal.</li> <li>0 to 5000 [ms]</li> </ul>	0	32801+10n
[Pr.302] Servo input axis phase compensation advance time	<ul style="list-style-type: none"> <li>Set the time to advance or delay the phase.</li> </ul> <u>Fetch cycle: Operation cycle</u>	<ul style="list-style-type: none"> <li>Set in decimal.</li> <li>-2147483648 to 2147483647 [<math>\mu</math>s]</li> </ul>	0	32802+10n 32803+10n
[Pr.303] Servo input axis phase compensation time constant	<ul style="list-style-type: none"> <li>Set the time constant to affect the phase compensation.</li> </ul> <u>Fetch cycle: At power supply ON</u>	<ul style="list-style-type: none"> <li>Set in decimal.</li> <li>0 to 65535 [ms] (Note-1)</li> </ul>	10	32804+10n
[Pr.304] Servo input axis rotation direction restriction	<ul style="list-style-type: none"> <li>Set this parameter to restrict the input travel value to one direction.</li> </ul> <u>Fetch cycle: At power supply ON</u>	<ul style="list-style-type: none"> <li>Set in decimal.</li> <li>0: Without rotation direction restriction</li> <li>1: Enable only for current value increase direction</li> <li>2: Enable only for current value decrease direction</li> </ul>	0	32805+10n

n: Axis No.-1

(Note-1): Set the value as follows in a program.

0 to 32767 ..... Set as a decimal.

32768 to 65535 ..... Convert into a hexadecimal and set.

[Pr.300] Servo input axis type

Set the current value type to be generated of the input value for the servo input axis.

- 0: Invalid..... Servo input axis is invalid.
- 1: Feed current value ..... Generate the input value based on "[Md.20] Feed current value".
- 2: Real current value ..... Generate the input value based on the real current value, which is converted into units of the encoder feedback pulses from the servo amplifier.
- 3: Servo command value ..... Generate the input value based on the command pulse for the servo amplifier (a value that the feed current value is converted into encoder pulse units).
- 4: Feedback value ..... Generate the input value based on the encoder feedback pulse from the servo amplifier.

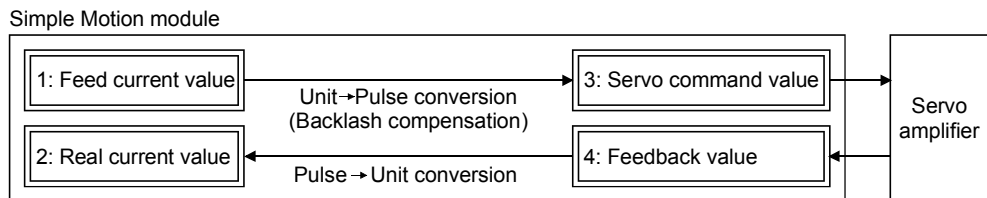

[Pr.301] Servo input axis smoothing time constant

Set the averaging time to execute a smoothing process for the input travel value from the servo input axis.

The smoothing process can moderate speed fluctuation, when the "Real current value" or "Feedback value" is used as input values.

The input response is delayed depending on the time corresponding to the setting by smoothing process setting.

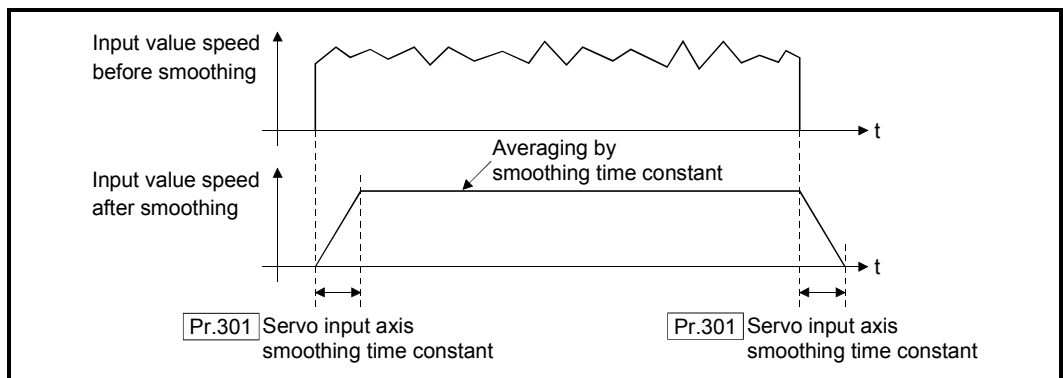

[Pr.302] Servo input axis phase compensation advance time

Set the time to advance or delay the phase (input response) of the servo input axis. Refer to Section 4.8 "Phase compensation function" for the peculiar time delay of the system using the servo input axis.

1 to 2147483647 [ $\mu$ s]..... Advance the phase (input response) according to the setting time.

0 [ $\mu$ s] ..... Do not execute phase compensation.

-2147483648 to -1 [ $\mu$ s] ..... Delay the phase (input response) according to the setting time.

If the setting time is too long, the system experiences overshoot or undershoot at acceleration/deceleration of the input speed. In this case, set longer time to affect the phase compensation amount in "[Pr.303] Servo input axis phase compensation time constant".

[Pr.303] Servo input axis phase compensation time constant

Set the time constant to affect the phase compensation amount for the first order delay. 63 [%] of the phase compensation amount are reflected in the time constant setting.

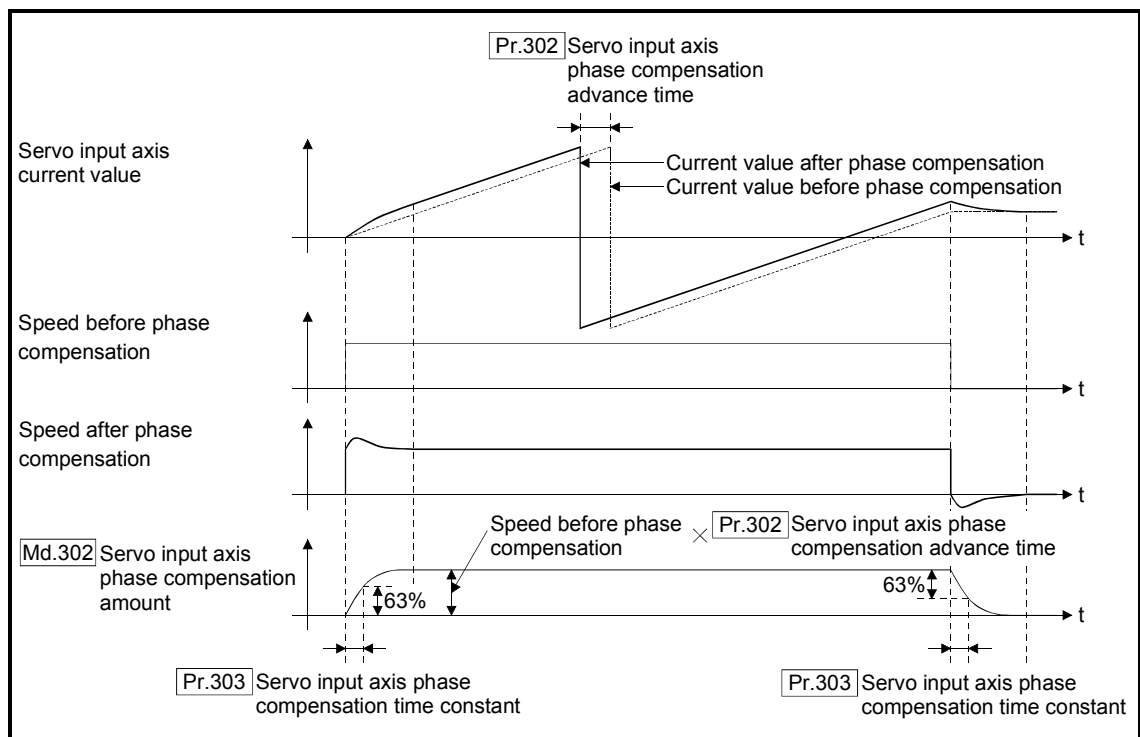



[Pr.304] Servo input axis rotation direction restriction

Set this parameter to restrict the input travel value for the servo input axis to one direction. This helps to avoid reverse operation caused by machine vibration, etc. when "Real current value" or "Feedback value" is used as input values.

- 0: Without rotation direction restriction .....Rotation direction restriction is not executed.
- 1: Enable only for current value increase direction .....Enable only the input travel value in the increasing direction of the servo input axis current value.
- 2: Enable only for current value decrease direction .....Enable only the input travel value in the decreasing direction of the servo input axis current value.

The input travel value in the opposite direction of the enabled direction accumulates as a rotation direction restricted amount, and will be reflected when the input travel value moves in the enabled direction again. Therefore, the current value of servo input does not deviate when the reverse operation is repeated.

The rotation direction restricted amount is set to 0 when the following operations are executed for the servo input axis.

- A servo amplifier is connected
- An HPR is executed
- The current value is changed

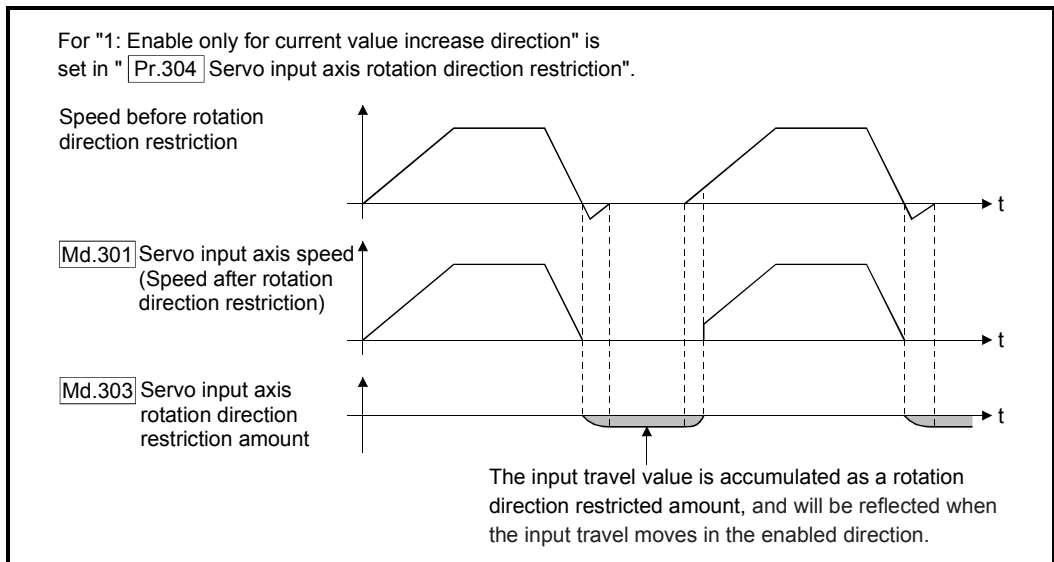

## 2.1.3 Servo input axis monitor data

Monitor item	Storage details	Monitor value	Buffer memory address
[Md.300] Servo input axis current value	<ul style="list-style-type: none"> <li>The current value for the servo input axis is stored.</li> </ul> <u>Refresh cycle: Operation cycle</u>	<ul style="list-style-type: none"> <li>Monitoring is carried out in decimal. -2147483648 to 2147483647 [Servo input axis position units (Note-1)]</li> </ul>	33120+10n 33121+10n
[Md.301] Servo input axis speed	<ul style="list-style-type: none"> <li>The speed for the servo input axis is stored.</li> </ul> <u>Refresh cycle: Operation cycle</u>	<ul style="list-style-type: none"> <li>Monitoring is carried out in decimal. -2147483648 to 2147483647 [Servo input axis speed units (Note-2)]</li> </ul>	33122+10n 33123+10n
[Md.302] Servo input axis phase compensation amount	<ul style="list-style-type: none"> <li>The current phase compensation amount is stored.</li> </ul> <u>Refresh cycle: Operation cycle</u>	<ul style="list-style-type: none"> <li>Monitoring is carried out in decimal. -2147483648 to 2147483647 [Servo input axis position units (Note-1)]</li> </ul>	33124+10n 33125+10n
[Md.303] Servo input axis rotation direction restriction amount	<ul style="list-style-type: none"> <li>While the rotation direction is restricted, the accumulation for the input travel value in the opposite direction of the enabled direction is stored.</li> </ul> <u>Refresh cycle: Operation cycle</u>	<ul style="list-style-type: none"> <li>Monitoring is carried out in decimal. -2147483648 to 2147483647 [Servo input axis position units (Note-1)]</li> </ul>	33126+10n 33127+10n

n: Axis No.-1

(Note-1): Servo input axis position units (Refer to Section 2.1.1)

(Note-2): Servo input axis speed units (Refer to Section 2.1.1)

## [Md.300] Servo input axis current value

The current value for the servo input axis is stored in servo input axis position units (Refer to Section 2.1.1) as follows.

The current value for the servo input axis is the value after processing the smoothing, the phase compensation and the rotation direction restriction.

Setting value of "[Pr.300] Servo input axis type"	Storage details
1: Feed current value 2: Real current value	<ul style="list-style-type: none"> <li>The accumulative current value started with "[Md.20] Feed current value"/"[Md.101] Real current value" for the connection to the servo amplifier is stored. It is also stored in the range from -21474.83648 to 21474.83647 [degree] for degree units.</li> <li>When the "[Md.20] Feed current value"/"[Md.101] Real current value" is changed by an HPR or a current value change, the value is changed to the new current value.</li> </ul>
3: Servo command value 4: Feedback value	<ul style="list-style-type: none"> <li>When of the absolute position detection system setting is invalid, the accumulative current value that starts from 0 for the connected servo amplifier is stored.</li> <li>When of the absolute position detection system setting is valid, the accumulative current value that starts from the absolute position command/encoder feedback pulse for the connected servo amplifier is stored.</li> <li>The servo input axis current value will not change, even if an HPR or the current value is changed.</li> </ul>

**[Md.301] Servo input axis speed**

The speed for the servo input axis is stored in servo input axis speed units (Refer to Section 2.1.1).

The speed for the servo input axis is the value after processing smoothing, phase compensation, and rotation direction restriction.

**[Md.302] Servo input axis phase compensation amount**

The phase compensation amount for a servo input axis is stored in servo input axis position units (Refer to Section 2.1.1).

The phase compensation amount for a servo input axis is the value after processing smoothing and phase compensation.

**[Md.303] Servo input axis rotation direction restriction amount**

While the rotation direction is restricted for a servo input axis, the accumulation for input travel value in the opposite direction of the enabled direction is stored in servo input axis position units (Refer to Section 2.1.1) as follows.

Setting value of "[Pr.304] Servo input axis rotation direction restriction"	Storage details
1: Enable only for current value increase direction	A negative accumulation is stored during rotation direction restriction. 0 is stored if there is no restriction.
2: Enable only for current value decrease direction	A positive accumulation is stored during rotation direction restriction. 0 is stored if there is no restriction.

Rotation direction restriction is processed after phase compensation processing. Therefore, if undershoot occurs from phase compensation during deceleration stop, the rotation direction restriction amount might remain.

## 2.2 Command generation axis **QD77MS** **LD77MS**

### 2.2.1 Overview of command generation axis

The command generation axis is an axis that executes command generation only. It can be controlled individually from the axis connected with a servo amplifier.

The command generation axis is used to drive the input axis based on the positioning data or the JOG operation. The axis set in "[Pr.100] Servo series" is defined as "servo amplifier axis" against "command generation axis".

#### [1] Control method for the command generation axis

The command generation axis operates following to the positioning data and control data of the command generation axis.

The controls that can be used for the command generation axis are shown below.

Control mode	Control	Availability
Linear control	ABS linear 1, INC linear 1	○
	ABS linear 2, INC linear 2	×
	ABS linear 3, INC linear 3	
	ABS linear 4, INC linear 4	
Circular interpolation control	ABS circular sub, ABS circular right, ABS circular left INC circular sub, INC circular right, INC circular left	×
Fixed-feed	Fixed-feed 1, Fixed-feed 2, Fixed-feed 3, Fixed-feed 4	×
Speed control	Forward run speed 1, Reverse run speed 1	○
	Forward run speed 2, Reverse run speed 2	×
	Forward run speed 3, Reverse run speed 3	
	Forward run speed 4, Reverse run speed 4	
Speed-position control	Forward run speed/position, Reverse run speed/position	○
Position-speed control	Forward run position/speed, Reverse run position/speed	×
Current value change		○
Simultaneous start		×
JOG operation		○
Manual pulse generator operation		×
HPR		×

○: Available, ×: Not available

The control details are common with "major positioning controls". For details, refer to the "User's Manual (Positioning Control)" of each Simple Motion module.

The sub functions that can be used for the command generation axis are shown below.

Control mode	HPR retry function	HP shift function	Backlash compensation function	Electronic gear function	Near pass function
ABS linear 1	×	×	×	×	△ (Note-1)
INC linear 1	×	×	×	×	△ (Note-1)
Forward run speed 1	×	×	×	×	△ (Note-1)
Reverse run speed 1	×	×	×	×	△ (Note-1)
Forward run speed/position	×	×	×	×	△ (Note-1)
Reverse run speed/position	×	×	×	×	△ (Note-1)
Current value change	×	×	×	×	△ (Note-1)
JOG operation	×	×	×	×	×

△: Combination restricted ×: Combination not possible

(Note-1): The near pass function is validated only when the machine of the standard specification carries out the position control with the continuous path control mode.

Control mode	Speed limit function	Torque limit function	Software stroke limit function	Hardware stroke limit function	Forced stop function
ABS linear 1	○	×	○	×	○
INC linear 1	○	×	○	×	○
Forward run speed 1	○	×	○	×	○
Reverse run speed 1	○	×	○	×	○
Forward run speed/position	○	×	○	×	○
Reverse run speed/position	○	×	○	×	○
Current value change	×	×	○	×	○
JOG operation	○	×	○	×	○

○: Combination possible ×: Combination not possible

Control mode	Speed change function	Override function	Acceleration/ deceleration time change function	Torque change function	Target position change function
ABS linear 1	○	○	○	×	△ (Note-2)
INC linear 1	○	○	○	×	△ (Note-2)
Forward run speed 1	○	○	○	×	×
Reverse run speed 1	○	○	○	×	×
Forward run speed/position	○	○	○	×	×
Reverse run speed/position	○	○	○	×	×
Current value change	×	×	×	×	×
JOG operation	○	○	○	×	×

○: Combination possible △: Combination restricted ×: Combination not possible

(Note-2): Invalid during the continuous path control mode.

Control mode	Step function	Skip function	M code output function	Teaching function	Command in-position function
ABS linear 1	×	×	○	×	○
INC linear 1	×	×	○	×	○
Forward run speed 1	×	×	○	×	○
Reverse run speed 1	×	×	○	×	○
Forward run speed/position	×	×	○	×	○
Reverse run speed/position	×	×	○	×	○
Current value change	×	×	△ (Note-3)	×	×
JOG operation	×	×	×	×	×

○: Combination possible △: Combination restricted ×: Combination not possible

(Note-3): Execute the current value change using the positioning data. It is not output using the positioning start No.9003.

Control mode	Acceleration/deceleration processing function	Pre-reading start function	Deceleration start flag function	Stop command processing for deceleration stop function
ABS linear 1	○	×	○	○
INC linear 1	○	×	○	○
Forward run speed 1	○	×	×	○
Reverse run speed 1	○	×	×	○
Forward run speed/position	○	×	△ (Note-4)	○
Reverse run speed/position	○	×	△ (Note-4)	○
Current value change	×	×	×	×
JOG operation	○	×	×	×

○: Combination possible △: Combination restricted ×: Combination not possible

(Note-4): Valid only when the deceleration start during positioning control.

Control mode	Speed control 10 times multiplier setting for degree axis function	Operation setting for incompleteness of HPR function
ABS linear 1	○	×
INC linear 1	○	×
Forward run speed 1	○	×
Reverse run speed 1	○	×
Forward run speed/position	○	×
Reverse run speed/position	○	×
Current value change	×	×
JOG operation	○	×

○: Combination possible ×: Combination not possible

The following shows the support status excluding above.

Support status of functions that are not caused by positioning control

	Function	Support status
Sub functions	Absolute position system	×
	Continuous operation interrupt function	○
	Follow up function	×
Common functions	Test mode	×
Dedicated instructions	ZP.PSTRT (Positioning start)	×
	ZP.PSTRT (Teaching instruction)	×
	ZP.PFWRT (Writing to flash ROM)	○
	ZP.PINIT (Parameter initialization)	○

○: Compatible ×: Incompatible

■ Change command generation axis parameters and positioning data

The command generation axis does not store parameters or positioning data in the buffer memory. Therefore, rewrite the parameters and the positioning data using the following methods.

- When using GX Works2

Set the command generation axis parameters and positioning data using GX Works2. After that, execute "writing to the Simple Motion module".

- When using command generation axis control data

[Change command generation axis parameters]

Use the following control data. For details, refer to Section 2.2.6.

- [Cd.300] Command generation axis parameter No. designation
- [Cd.301] Command generation axis parameter setting value
- [Cd.302] Command generation axis parameter control request

[Change command generation axis positioning data]]

Use the following control data. For details, refer to Section 2.2.6.

- [Cd.303] Command generation axis positioning data No. designation
- [Cd.304] Command generation axis positioning data designation
- [Cd.305] Command generation axis positioning data setting value
- [Cd.306] Command generation axis positioning data control request

■ Setting for command generation axis

Set "1: Valid" in "[Pr.340] Command generation axis valid setting" using the methods above. The command generation axis setting is fetched at the power ON. Therefore, to disconnect the command generation axis, turn ON the Simple Motion module power supply again after setting "0: Invalid" in "[Pr.340] Command generation axis valid setting".

■ Start request

Specify the positioning data No. in "[Cd.3] Positioning start No." and set "1: ON" in "[Cd.184] Positioning start". The start complete signal ([Md.31] Status: b14) and "[Md.141] BUSY" turn ON, and the positioning operation starts.

■ Troubleshooting

Output the axis error and warning which are same as the servo amplifier axis to "[Md.23] Axis error No." and "[Md.24] Axis warning No." of the command generation axis. Output the error history and the warning history as the axis No.201.

## [2] Units for the command generation axis

The position units and speed units for the command generation axis are shown below based on the setting "[Pr.1] Unit setting".

### ■ Command generation axis position units

Setting value of "[Pr.1] Unit setting"	Command generation axis position unit	Range
0: mm	$\times 10^{-1} \mu\text{m}$	-214748364.8 to 214748364.7 [ $\mu\text{m}$ ]
1: inch	$\times 10^{-5}$ inch	-21474.83648 to 21474.83647 [inch]
2: degree	$\times 10^{-5}$ degree	0.00000 to 359.99999 [degree]
3: PLS	PLS	-2147483648 to 2147483647 [PLS]

### ■ Command generation axis speed units

Setting value of "[Pr.1] Unit setting"	Command generation axis position unit	Range
0: mm	$\times 10^{-2}$ mm/min	-21474836.48 to 21474836.47 [mm/min]
1: inch	$\times 10^{-3}$ inch/min	-2147483.648 to 2147483.647 [inch/min]
2: degree	$\times 10^{-3}$ degree/min <sup>(Note-1)</sup>	-2147483.648 to 2147483.647 [degree/min] <sup>(Note-1)</sup>
3: PLS	PLS/s	-2147483648 to 2147483647 [PLS/s]

(Note-1): This will be the speed unit " $\times 10^{-2}$  degree/min" (Range: -21474836.48 to 21474836.47 [degree/min]), when "[Pr.83] Speed control 10  $\times$  multiplier setting for degree axis" is valid.

## [3] Operation at forced stop

When the command generation axis starts while "0: Valid" is set to "[Pr.82] Forced stop valid/invalid selection", the error "Start not possible" (error code: 108) occurs and the command generation axis does not start. When the forced stop input signal turns OFF during operation, the axis stops rapidly according to the setting of "[Pr.36] Rapid stop deceleration time" and "1:Stopped" is set in "[Md.26] Axis operation status".

The forced stop setting can be changed by "[Pr.82] Forced stop valid/invalid selection". "[Pr.82] Forced stop valid/invalid selection" and "forced stop input signal" are common with the servo amplifier axis.



## 2.2.2 Command generation axis parameters

All command generation axis parameters are prepared for each command generation axis. However, change the parameters using GX Works2 or control data because the parameters are not in the buffer memory.

Setting item	Setting details	Setting value	Default value	Buffer memory address
[Pr.340] Command generation axis valid setting	<ul style="list-style-type: none"> <li>Set valid/invalid of the command generation axis to be used.</li> </ul> Fetch cycle: <u>At power supply ON</u>	■ Set in decimal. 0: Invalid 1: Valid	0	–
[Pr.346] Command generation axis length per cycle	<ul style="list-style-type: none"> <li>Set the length per cycle of the command generation axis.</li> </ul> Fetch cycle: <u>At power supply ON</u>	■ Set in decimal. 0: Invalid 1 to 2147483647 [Command generation axis position units <sup>(Note-1)</sup> ]	0	–

(Note-1): Command generation axis position units (Refer to Section 2.2.1).

### [Pr.340] Command generation axis valid setting

Set valid/invalid of the command generation axis.

0: Invalid ..... Command generation axis is invalid.

1: Valid ..... Command generation axis is valid.

### [Pr.346] Command generation axis length per cycle

Set the length per cycle for the command generation axis current value per cycle.

The current value of command generation axis is stored in "[Md.347] Command generation axis current value per cycle" at ring counter based on the setting value.

The unit settings are in command generation axis position units (Refer to Section 2.2.1).

Set a value within the range from 1 to 2147483647. If a value out of the range is input, the axis error "Outside command generation axis length per cycle setting error" (error code: 613) occurs and the axis operates as that the length per cycle is 0.

If "0" is set, "[Md.347] Command generation axis current value per cycle" is not updated.

## [1] List of parameters that can be used

Each parameter specification is common with the servo amplifier axis. For specification details, refer to the "User's Manual (Positioning Control)" of each Simple Motion module.

## ■ Basic parameters1

Name	Servo amplifier axis	Command generation axis
[Pr.1] Unit setting	○	○: Fetch cycle is at power supply ON
[Pr.2] Number of pulses per rotation (AP)	○	×
[Pr.3] Movement amount per rotation (AL)	○	×
[Pr.4] Unit magnification (AM)	○	×
[Pr.7] Bias speed at start	○	×

○: Available, ×: Not available

## ■ Basic parameters2

Name	Servo amplifier axis	Command generation axis
[Pr.8] Speed limit value	○	○
[Pr.9] Acceleration time 0	○	○
[Pr.10] Deceleration time 0	○	○

○: Available, ×: Not available

## ■ Detailed parameters1

Name	Servo amplifier axis	Command generation axis	
[Pr.11] Backlash compensation amount	○	×	
[Pr.12] Software stroke limit upper limit value	○	○: Initial value 0 (Note-1)	
[Pr.13] Software stroke limit lower limit value	○	○: Initial value 0 (Note-1)	
[Pr.14] Software stroke limit selection	○	×	
[Pr.15] Software stroke limit valid/invalid setting	○	○: Initial value 0 (Note-1)	
[Pr.16] Command in-position width	○	○	
[Pr.17] Torque limit setting value	○	×	
[Pr.18] M code ON signal output timing	○	○	
[Pr.19] Speed switching mode	○	○	
[Pr.20] Interpolation speed designation method	○	×	
[Pr.21] Feed current value during speed control	○	× (Note-2)	
[Pr.22] Input signal logic selection	b0: Lower limit	×	
	b1: Upper limit	×	
	b3: Stop signal	×	
	b4: External command signal/switching signal	○	×
	b6: Proximity dog signal	○	×
	b8: Manual pulse generator input	○	×
[Pr.24] Manual pulse generator/Incremental synchronous encoder input selection	○	×	
[Pr.80] External input signal selection	○	×	
[Pr.81] Speed-position function selection	○	×	
[Pr.82] Forced stop valid/invalid selection	○: Servo amplifier axis and command generation axis in common		

○: Available, ×: Not available

(Note-1): Different from the servo amplifier axis, the initial value of software stroke limit is invalid.

(Note-2): It operates fixed to 1.

### ■ Detailed parameters2

Name		Servo amplifier axis	Command generation axis
[Pr.25]	Acceleration time 1	○	○
[Pr.26]	Acceleration time 2	○	○
[Pr.27]	Acceleration time 3	○	○
[Pr.28]	Deceleration time 1	○	○
[Pr.29]	Deceleration time 2	○	○
[Pr.30]	Deceleration time 3	○	○
[Pr.31]	JOG speed limit value	○	○
[Pr.32]	JOG operation acceleration time selection	○	○
[Pr.33]	JOG operation deceleration time selection	○	○
[Pr.34]	Acceleration/deceleration process selection	○	○
[Pr.35]	S-curve ratio	○	○
[Pr.36]	Rapid stop deceleration time	○	○
[Pr.37]	Stop group 1 rapid stop selection	○	×
[Pr.38]	Stop group 2 rapid stop selection	○	○
[Pr.39]	Stop group 3 rapid stop selection	○	○
[Pr.40]	Positioning complete signal output time	○	○
[Pr.41]	Allowable circular interpolation error width	○	×
[Pr.42]	External command function selection	○	×
[Pr.83]	Speed control 10 times multiplier setting for degree axis	○	○
[Pr.84]	Restart allowable range when servo OFF to ON	○	×
[Pr.89]	Manual pulse generator/Incremental synchronous encoder input type selection	○	×
[Pr.90] Operation setting for speed-torque control mode	b4 to b7: Torque initial value selection	○	×
	b8 to b11: Speed initial value selection	○	×
	b12 to b15: Condition selection at mode switching	○	×
[Pr.95]	External command signal selection	○	×

○: Available, ×: Not available

### ■ HPR basic parameters

Name		Servo amplifier axis	Command generation axis
[Pr.43]	HPR method	○	×
[Pr.44]	HPR direction	○	×
[Pr.45]	HP address	○	×
[Pr.46]	HPR speed	○	×
[Pr.47]	Creep speed	○	×
[Pr.48]	HPR retry	○	×

○: Available, ×: Not available

### ■ HPR detailed parameters

Name	Servo amplifier axis	Command generation axis
[Pr.50] Setting for the movement amount after proximity dog ON	○	×
[Pr.51] HPR acceleration time selection	○	×
[Pr.52] HPR deceleration time selection	○	×
[Pr.53] HP shift amount	○	×
[Pr.54] HPR torque limit value	○	×
[Pr.55] Operation setting for incompleteness of HPR	○	×
[Pr.56] Speed designation during HP shift	○	×
[Pr.57] Dwell time during HPR retry	○	×

○: Available, ×: Not available

### ■ Extended parameters

Name	Servo amplifier axis	Command generation axis
[Pr.91] Optional data monitor: Data type setting 1	○	×
[Pr.92] Optional data monitor: Data type setting 2	○	×
[Pr.93] Optional data monitor: Data type setting 3	○	×
[Pr.94] Optional data monitor: Data type setting 4	○	×
[Pr.96] Operation cycle setting	○: Servo amplifier axis and command generation axis in common	
[Pr.97] SSCNET setting	○	×

○: Available, ×: Not available

## 2.2.3 Command generation axis control data

All command generation axis control data is prepared for each command generation axis.

Setting item	Setting details	Setting value	Default value	Buffer memory address
[Cd.184] Positioning start	• Positioning operation is started.	■ Set in decimal. 1 : Positioning start requested Other than 1: Positioning start not requested	0	61964+128n
[Cd.300] Command generation axis parameter No. designation	• Specify the parameter No. to be written.	■ Set in decimal. Parameter No. 1 to 400	0	61970+128n
[Cd.301] Command generation axis parameter setting value	• Specify the setting value to be written.	■ Set in decimal. -2147483648 to 2147483647	0	61972+128n 61973+128n
[Cd.302] Command generation axis parameter control request	• Set the writing command.	■ Set in hexadecimal. 0000H : Not request 0001H : Write request 0002H : Read request FFFFH : Write error	0000H	61971+128n
[Cd.303] Command generation axis positioning data No. designation	• Specify the positioning data No. to be written.	■ Set in decimal. Data No. 1 to 100	0	61974+128n
[Cd.304] Command generation axis positioning data designation	• Specify [Da._] of the positioning data No. to be written (positioning data, block start data, condition data).	■ Set in decimal. Data No. specification [Da.1] : 1 [Da.2] : 2 ⋮ [Da.26] : 26	0	61975+128n
[Cd.305] Command generation axis positioning data setting value	• Specify the setting value to be written.	■ Set in decimal. -2147483648 to 2147483647	0	61976+128n 61977+128n
[Cd.306] Command generation axis positioning data control request	• Set the writing command.	■ Set in hexadecimal. 0000H : Not request 0001H : Write request 0002H : Read request FFFFH : Write Error	0000H	61978+128n

n: Axis No.-1

[Pr.184] Positioning start

- Positioning operation is started.
- The positioning start signal is valid at the leading edge, and the operation is started.
- When the positioning start signal turns ON during BUSY, the warning "Start during operation" (warning code: 100) will occur.

[Cd.300] to [Cd.302] Command generation axis parameter

Refer to Section 2.2.6.

[Cd.303] to [Cd.306] Command generation axis positioning data

Refer to Section 2.2.6.

## [1] List of control data that can be used

The specification is common with the servo amplifier axis. For specification details, refer to the "User's Manual (Positioning Control)" of each Simple Motion module.

## ■ System control data

Name	Servo amplifier axis	Command generation axis
[Cd.1] Flash ROM write request	○: Servo amplifier axis and command generation axis in common	
[Cd.2] Parameter initialization request	○: Servo amplifier axis and command generation axis in common	
[Cd.41] Deceleration start flag valid	○: Servo amplifier axis and command generation axis in common	
[Cd.42] Stop command processing for deceleration stop selection	○: Servo amplifier axis and command generation axis in common	
[Cd.44] External input signal operation device (Axis 1 to 16)	○	×
[Cd.47] QD75MH initial value setting request/LD77MH initial value setting request	○: Servo amplifier axis and command generation axis in common	
[Cd.102] SSCNET control command	○	×
[Cd.137] Amplifier-less operation mode switching request	○	×

○: Available, ×: Not available

## ■ Axis control data

Name	Servo amplifier axis	Command generation axis
[Cd.3] Positioning start No.	○	○ (Note-1)
[Cd.4] Positioning starting point No.	○	×
[Cd.5] Axis error reset	○	○
[Cd.6] Restart command	○	○
[Cd.7] M code OFF request	○	○
[Cd.8] External command valid	○	×
[Cd.9] Current value change	○	○
[Cd.10] New acceleration time value	○	○
[Cd.11] New deceleration time value	○	○
[Cd.12] Acceleration/deceleration time change value during speed change, enable/disable	○	○
[Cd.13] Positioning operation speed override	○	○
[Cd.14] New speed value	○	○
[Cd.15] Speed change request	○	○
[Cd.16] Inching movement amount	○	×
[Cd.17] JOG speed	○	○
[Cd.18] Interrupt request during continuous operation	○	○
[Cd.19] HPR request flag OFF request	○	×
[Cd.20] Manual pulse generator 1 pulse input magnification	○	×
[Cd.21] Manual pulse generator enable flag	○	×
[Cd.22] New torque value/forward new torque value	○	×

○: Available, ×: Not available

(Note-1): The setting range is 1 to 100: Positioning data No. and 9003: Current value changing.

Name		Servo amplifier axis	Command generation axis
[Cd.23] Speed-position switching control movement amount change register		○	○
[Cd.24] Speed-position switching enable flag		○	○
[Cd.25] Position-speed switching control speed change register		○	×
[Cd.26] Position-speed switching enable flag		○	×
[Cd.27] Target position change value (New address)		○	○
[Cd.28] Target position change value (New speed)		○	○
[Cd.29] Target position change request flag		○	○
[Cd.30] Simultaneous starting own axis start data No.		○	×
[Cd.31] Simultaneous starting axis start data No.1		○	×
[Cd.32] Simultaneous starting axis start data No.2		○	×
[Cd.33] Simultaneous starting axis start data No.3		○	×
[Cd.34] Step mode		○	×
[Cd.35] Step valid flag		○	×
[Cd.36] Step start information		○	×
[Cd.37] Skip command		○	×
[Cd.38] Teaching data selection		○	×
[Cd.39] Teaching positioning data No.		○	×
[Cd.40] ABS direction in degrees		○	○
[Cd.43] Simultaneous starting axis		○	×
[Cd.45] Speed-position switching device selection		○	× (Note-2)
[Cd.46] Speed-position switching command		○	○
[Cd.100] Servo OFF command		○	×
[Cd.101] Torque output setting value		○	×
[Cd.108] Gain changing command flag		○	×
[Cd.112] Torque change function switching request		○	×
[Cd.113] New reverse torque value		○	×
[Cd.130] Servo parameter write request		○	×
[Cd.131] Parameter No. (Setting for servo parameters to be changed)	Parameter No. setting	○	×
	Parameter group		
	Writing mode		
[Cd.132] Change data		○	×
[Cd.133] Semi/Fully closed loop switching request		○	×
[Cd.136] PI-PID switching request		○	×
[Cd.138] Control mode switching request		○	×
[Cd.139] Control mode setting		○	×
[Cd.140] Command speed at speed control mode		○	×
[Cd.141] Acceleration time at speed control mode		○	×
[Cd.142] Deceleration time at speed control mode		○	×
[Cd.143] Command torque at torque control mode		○	×
[Cd.144] Torque time constant at torque control mode (Forward direction)		○	×
[Cd.145] Torque time constant at torque control mode (Negative direction)		○	×
[Cd.146] Speed limit value at torque control mode		○	×

○: Available, ×: Not available

(Note-2): It is fixed to the initial value 2.



Name	Servo amplifier axis	Command generation axis
[Cd.147] Speed limit value at continuous operation to torque control mode	○	×
[Cd.148] Acceleration time at continuous operation to torque control mode	○	×
[Cd.149] Deceleration time at continuous operation to torque control mode	○	×
[Cd.150] Target torque at continuous operation to torque control mode	○	×
[Cd.151] Torque time constant at continuous operation to torque control mode (Forward direction)	○	×
[Cd.152] Torque time constant at continuous operation to torque control mode (Negative direction)	○	×
[Cd.153] Control mode auto-shift selection	○	×
[Cd.154] Control mode auto-shift parameter	○	×
[Cd.180] Axis stop	○	○
[Cd.181] Forward run JOG start	○	○
[Cd.182] Reverse run JOG start	○	○
[Cd.183] Execution prohibition flag	○	×
[Cd.184] Positioning start	○ (Note-3)	○

○: Available, ×: Not available

(Note-3): It is held in the output signal for the servo amplifier axis.

## 2.2.4 Command generation axis monitor data

Monitor item	Storage details	Monitor value	Buffer memory address
[Md.141] BUSY	<ul style="list-style-type: none"> <li>The BUSY status is stored.</li> </ul> Refresh cycle: Operation cycle	■ Monitoring is carried out in decimal. 1 : BUSY Other than 1 : Not BUSY	61004+120n
[Md.345] Command generation axis accumulative current value	<ul style="list-style-type: none"> <li>The accumulative current value for the command generation axis is stored.</li> </ul> Refresh cycle: Operation cycle	■ Monitoring is carried out in decimal. -2147483648 to 2147483647 [Command generation axis position units (Note-1)]	61000+120n 61001+120n
[Md.347] Command generation axis current value per cycle	<ul style="list-style-type: none"> <li>The current value per cycle for the command generation axis is stored.</li> </ul> Refresh cycle: Operation cycle	■ Monitoring is carried out in decimal. 0 to (Command generation axis length per cycle - 1) [Command generation axis position units (Note-1)]	61002+120n 61003+120n

n: Axis No.-1

(Note-1): Command generation axis position units (Refer to Section 2.2.1)

## [Md.141] BUSY

- This signal turns ON at the start of positioning or JOG operation. It turns OFF when the "[Da.9] Dwell time/JUMP destination positioning data No." has passed after positioning stops. (This signal remains ON during positioning.)
- This signal turns OFF at error completion or positioning stop.

## POINT

The BUSY signal turns ON even when position control of movement amount 0 is executed. However, since the ON time is short, the ON status may not be detected in the sequence program.

## [Md.345] Command generation axis accumulative current value

The accumulative current value for the command generation axis is stored in the "[Pr.1] Unit setting". The axis whose unit setting is other than "degree" is set to "feed current value = accumulative current value".

## [Md.347] Command generation axis current value per cycle

The current value per cycle for the command generation axis is stored in the range from 0 to ("[Pr.346] Command generation axis length per cycle" - 1).

## [1] List of monitor data that can be used

The specification is common with the servo amplifier axis. For specification details, refer to the "User's Manual (Positioning Control)" of each Simple Motion module.

■ System monitor data

Name	Servo amplifier axis	Command generation axis
[Md.3] Start information Start	○	×
[Md.4] Start No.	○	×
[Md.54] Start (Year: month)	○	×
[Md.5] Start (Day: hour)	○	×
[Md.6] Start (Minute: second)	○	×
[Md.7] Error judgment	○	×
[Md.8] Start history pointer	○	×
[Md.9] Axis in which the error occurred	○: Servo amplifier axis and command generation axis in common	
[Md.10] Axis error No.	○: Servo amplifier axis and command generation axis in common	
[Md.57] Servo alarm	○: Servo amplifier axis and command generation axis in common	
[Md.61] Driver operation alarm number	○: Servo amplifier axis and command generation axis in common	
[Md.55] Axis error occurrence (Year: month)	○: Servo amplifier axis and command generation axis in common	
[Md.11] Axis error occurrence (Day: hour)	○: Servo amplifier axis and command generation axis in common	
[Md.12] Axis error occurrence (Minute: second)	○: Servo amplifier axis and command generation axis in common	
[Md.13] Error history pointer	○: Servo amplifier axis and command generation axis in common	
[Md.14] Axis in which the warning occurred	○: Servo amplifier axis and command generation axis in common	
[Md.15] Axis warning No.	○: Servo amplifier axis and command generation axis in common	
[Md.58] Servo warning	○: Servo amplifier axis and command generation axis in common	
[Md.56] Axis warning occurrence (Year: month)	○: Servo amplifier axis and command generation axis in common	
[Md.16] Axis warning occurrence (Day: hour)	○: Servo amplifier axis and command generation axis in common	
[Md.17] Axis warning occurrence (Minute: second)	○: Servo amplifier axis and command generation axis in common	
[Md.18] Warning history pointer	○: Servo amplifier axis and command generation axis in common	
[Md.19] Number of write accesses to flash ROM	○: Servo amplifier axis and command generation axis in common	
[Md.50] Forced stop input	○: Servo amplifier axis and command generation axis in common	
[Md.51] Amplifier-less operation mode status	○	×
[Md.52] Communication between amplifiers axes searching flag	○	×
[Md.53] SSCNET control status	○	×
[Md.59] Module information	○	×
[Md.130] OS version	○: Servo amplifier axis and command generation axis in common	
[Md.131] Digital oscilloscope running flag	○: Servo amplifier axis and command generation axis in common	
[Md.132] Operation cycle setting	○: Servo amplifier axis and command generation axis in common	
[Md.133] Operation cycle over flag	○: Servo amplifier axis and command generation axis in common	
[Md.134] Operation time	○: Servo amplifier axis and command generation axis in common	
[Md.135] Maximum operation time	○: Servo amplifier axis and command generation axis in common	

○: Available, ×: Not available

■ Axis monitor data

Name		Servo amplifier axis	Command generation axis
[Md.20]	Feed current value	○	○
[Md.21]	Feed machine value	○	×
[Md.22]	Feedrate	○	○
[Md.23]	Axis error No.	○	○
[Md.24]	Axis warning No.	○	○
[Md.25]	Valid M code	○	○
[Md.26]	Axis operation status	○	○
[Md.27]	Current speed	○	○
[Md.28]	Axis feedrate	○	○
[Md.29]	Speed-position switching control positioning movement amount	○	○
[Md.30]	b0: Lower limit signal	○	×
	b1: Upper limit signal	○	×
	b3: Stop signal	○	×
	b4: External command signal/switching signal	○	×
	b6: Proximity dog signal	○	×
[Md.31]	b0: In speed control flag	○	○
	b1: Speed-position switching latch flag	○	○
	b2: Command in- position flag	○	○
	b3: HPR request flag	○	×
	b4: HPR complete flag	○	×
	b5: Position-speed switching latch flag	○	×
	b9: Axis warning detection	○	○
	b10: Speed change 0 flag	○	○
	b12: M code ON	○	○
	b13: Error detection	○	○
	b14: Start complete	○	○
b15: Positioning complete	○	○	
[Md.32]	Target value	○	○
[Md.33]	Target speed	○	○
[Md.34]	Movement amount after proximity dog ON	○	×
[Md.35]	Torque limit stored value/forward torque limit stored value	○	×
[Md.36]	Special start data instruction code setting value	○	×

○: Available, ×: Not available

Name		Servo amplifier axis	Command generation axis
[Md.37]	Special start data instruction parameter setting value	○	×
[Md.38]	Start positioning data No. setting value	○	○
[Md.39]	In speed limit flag	○	○
[Md.40]	In speed change processing flag	○	○
[Md.41]	Special start repetition counter	○	×
[Md.42]	Control system repetition counter	○	○
[Md.43]	Start data pointer being executed	○	×
[Md.44]	Positioning data No. being executed	○	○
[Md.45]	Block No. being executed	○	×
[Md.46]	Last executed positioning data No.	○	○
[Md.47]	Positioning identifier	○	○
	M code	○	○
	Dwell time	○	○
	Axis to be interpolated	○	×
	Command speed	○	○
	Positioning address	○	○
	Arc address	○	×
[Md.48]	Deceleration start flag	○	○
[Md.100]	HPR re-travel value	○	×
[Md.101]	Real current value	○	×
[Md.102]	Deviation counter value	○	×
[Md.103]	Motor rotation speed	○	×
[Md.104]	Motor current value	○	×
[Md.106]	Servo amplifier software No.	○	×
[Md.107]	Parameter error No.	○	×
[Md.108]	b0: READY ON	○	×
	b1: Servo ON	○	×
	b2, b3: Control mode	○	×
	b4: Gain switching	○	×
	b5: Fully closed loop control	○	×
	b7: Servo alarm	○	×
	b12: In-position	○	×
	b13: Torque limit	○	×
	b14: Absolute position lost	○	×
b15: Servo warning	○	×	
[Md.108]	b0: Zero point pass	○	×
	b3: Zero speed	○	×
	b4: Speed limit	○	×
	b8: PID control	○	×
[Md.109]	Regenerative load ratio/Optional data monitor output 1	○	×
[Md.110]	Effective load torque/Optional data monitor output 2	○	×
[Md.111]	Peak torque ratio/Optional data monitor output 3	○	×
[Md.112]	Optional data monitor output 4	○	×

○: Available, ×: Not available

Name		Servo amplifier axis	Command generation axis
[Md.113]	Semi/Fully closed loop status	○	×
[Md.114]	Servo alarm	○	×
[Md.116]	Encoder option information	○	×
[Md.120]	Reverse torque limit stored value	○	×
[Md.122]	Speed during command	○	○
[Md.123]	Torque during command	○	×
[Md.124]	Control mode switching status	○	×
[Md.125]	Servo status3 b14: Continuous operation to torque control mode	○	×
[Md.141]	BUSY	○ (Note-1)	○
[Md.500]	Servo status7	○	×
[Md.502]	Driver operation alarm No.	○	×

○: Available, ×: Not available

(Note-1): It is held in the output signal for the servo amplifier axis.

## 2.2.5 Command generation axis positioning data

All positioning data is not in the buffer memory. Therefore, change the data using GX Works2 or control data. The specification of command generation axis positioning data is common with "major positioning controls". However, the positioning data is 100 points for each axis. The control methods that can be used are "ABS linear 1, INC linear 1, Forward run: speed 1, Reverse run: speed 1, Forward run: speed/position, Reverse run: speed/position". For details of "major positioning controls", refer to the "User's Manual (Positioning control)" of each Simple Motion module.

### [1] List of positioning data that can be used

The specification is common with the servo amplifier axis. For specification details, refer to the "User's Manual (Positioning Control)" of each Simple Motion module.

#### ■ Positioning data

Name	Servo amplifier axis	Command generation axis
[Da.1] Operation pattern	○	○
[Da.2] Control method	○	○
[Da.3] Acceleration time No.	○	○
[Da.4] Deceleration time No.	○	○
[Da.5] Axis to be interpolated	○	×
[Da.6] Positioning address/movement amount	○	○
[Da.7] Arc address	○	×
[Da.8] Command speed	○	○
[Da.9] Dwell time/JUMP destination positioning data No.	○	○
[Da.10] M code/Number of LOOP to LEND repetitions	○	○
[Da.10] Condition data No.	○	×
[Da.20] Axis to be interpolated No.1	○	×
[Da.21] Axis to be interpolated No.2	○	×
[Da.22] Axis to be interpolated No.3	○	×

○: Available, ×: Not available

#### POINT

When the speed control is selected in "[Da.1] Operation pattern", set invalid to "[Pr.15] Software stroke limit valid/invalid setting" as necessary.

#### ■ Setting range of "[Da.2] Control method"

Name	Servo amplifier axis	Command generation axis
01h: ABS linear 1	○	○
02h: INC linear 1	○	○
03h: Fixed-feed 1	○	×
04h: Forward run speed 1	○	○
05h: Reverse run speed 1	○	○
06h: Forward run speed/position	○	○
07h: Reverse run speed/position	○	○
08h: Forward run position/speed	○	×

○: Available, ×: Not available

Name	Servo amplifier axis	Command generation axis
09h: Reverse run position/speed	○	×
0Ah: ABS linear 2	○	×
0Bh: INC linear 2	○	×
0Ch: Fixed-feed 2	○	×
0Dh: ABS circular sub	○	×
0Eh: INC circular sub	○	×
0Fh: ABS circular right	○	×
10h: ABS circular left	○	×
11h: INC circular right	○	×
12h: INC circular left	○	×
13h: Forward run speed 2	○	×
14h: Reverse run speed 2	○	×
15h: ABS linear 3	○	×
16h: INC linear 3	○	×
17h: Fixed-feed 3	○	×
18h: Forward run speed 3	○	×
19h: Reverse run speed 3	○	×
1Ah: ABS linear 4	○	×
1Bh: INC linear 4	○	×
1Ch: Fixed-feed 4	○	×
1Dh: Forward run speed 4	○	×
1Eh: Reverse run speed 4	○	×
80h: NOP	○	○
81h: Current value changing	○	○
82h: JUMP instruction	○	○
83h: LOOP	○	○
84h: LEND	○	○

○: Available, ×: Not available

### ■ Block start data

Name	Servo amplifier axis	Command generation axis
[Da.11] Shape	○	×
[Da.12] Start data No.	○	×
[Da.13] Special start instruction	○	×
[Da.14] Parameter	○	×

○: Available, ×: Not available

### ■ Condition data

Name	Servo amplifier axis	Command generation axis
[Da.15] Condition target	○	×
[Da.16] Condition operator	○	×
[Da.17] Address	○	×
[Da.18] Parameter 1	○	×
[Da.19] Parameter 2	○	×
[Da.23] Number of simultaneous starting axes	○	×
[Da.24] Simultaneous starting axis No.1	○	×
[Da.25] Simultaneous starting axis No.2	○	×
[Da.26] Simultaneous starting axis No.3	○	×

○: Available, ×: Not available



## 2.2.6 Write/read method for command generation axis parameter and positioning data

The command generation axis parameter and positioning data are not stored in the buffer memory, so that each setting value changes by the control data. The fetch timing of each parameter and positioning data is in accordance with each specification. Therefore, some parameter is not used for control until PLC READY ON or the power supply ON.

POINT
<ul style="list-style-type: none"> <li>• Execute the writing of the parameter and positioning data by the write method procedure shown below. If the writing order is wrong, an unpredictable value might be set.</li> <li>• The command generation axis control data and positioning data written by this method are erased at the power supply OFF. When it is necessary to save the data, write to the flash ROM of the Simple Motion module by "[Cd.1] Flash ROM write request".</li> </ul>

### [1] Write method for command generation axis parameter

- (1) Specify the command generation axis parameter No. to "[Cd.300] Command generation axis parameter No. designation".
- (2) When "340" is set, "[Pr.340] Command generation axis valid setting" is specified. When "1" is set, "[Pr.1] Unit setting" is specified.
- (3) Specify the setting value to the command generation axis parameter with 2 words in "[Cd.301] Command generation axis parameter setting value".
- (4) Set "1: Write request" to "[Cd.302] Command generation axis parameter control request".
- (5) "[Cd.301] Command generation axis parameter setting value" is written to the command generation axis parameter No. specified in "[Cd.300] Command generation axis parameter No. designation". When the writing is succeeded, "0: Not request" is set in "[Cd.302] Command generation axis parameter control request".
- (6) When the parameter No. which is not defined to the command generation axis is specified, "FFFFH: Write error" is set in "[Cd.302] Command generation axis parameter control request". "[Cd.302] Command generation axis parameter control request" is detected always. It is not required to return to "0: Not request" from "FFFFH: Write error" manually.
- (7) The command generation axis control data and positioning data written by this method are erased at the power supply OFF. When it is necessary to save the data, write to the flash ROM of the Simple Motion module by "[Cd.1] Flash ROM write request".

The timing that the command generation axis parameter to be written becomes valid is common with the servo amplifier axis. For specification details, refer to the "User's Manual (Positioning Control)" of each Simple Motion module.

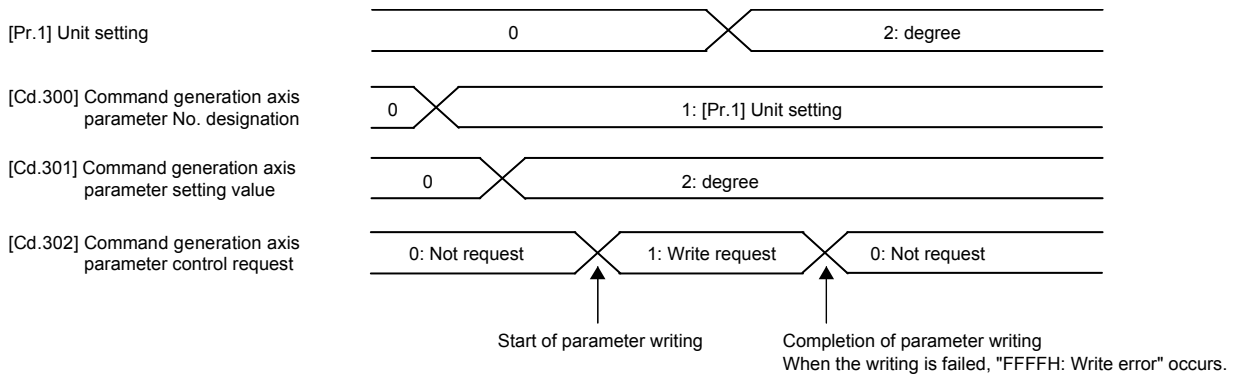

## [2] Read method for command generation axis parameter

- (1) Specify the command generation axis parameter No. to "[Cd.300] Command generation axis parameter No. designation".
- (2) Set "2: Read request" to "[Cd.302] Command generation axis parameter control request".
- (3) The setting value to the command generation axis parameter is read with 2 words in "[Cd.301] Command generation axis parameter setting value". "0: Not request" is set in "[Cd.302] Command generation axis parameter control request".
- (4) When the parameter No. which is not defined to the command generation axis is specified, "FFFFH: Write error" is set in "[Cd.302] Command generation axis parameter control request". "[Cd.302] Command generation axis parameter control request" is detected always. It is not required to return to "0: Not request" from "FFFFH: Write error" manually.

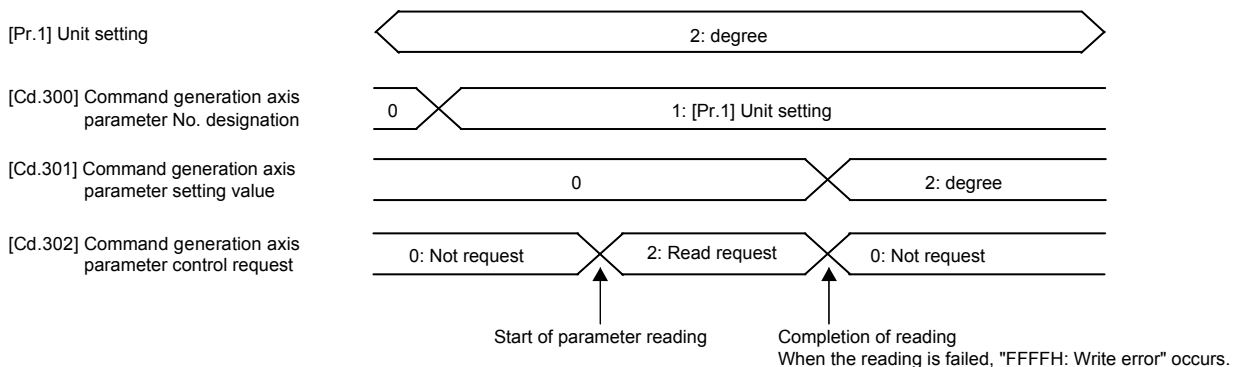

[3] Write method for command generation axis positioning data

- (1) Specify the command generation axis positioning data No. to "[Cd.303] Command generation axis positioning data No. designation". When "1" is set, "1" of the positioning data is specified.
- (2) Specify the command generation axis positioning data [Da.\_] to "[Cd.304] Command generation axis positioning data designation". When "1" is set, "[Da.1] Operation pattern" is specified.
- (3) Specify the setting value to the command generation axis positioning data No. and the command generation axis positioning data with 2 words to the low-order without space in "[Cd.305] Command generation axis positioning data setting value". To write ABS linear 1 in "[Da.2] Control method", specify "0000 0001H". When "0000 0100H" is specified, "0" is written.
- (4) Set "1: Write request" to "[Cd.306] Command generation axis positioning data control request". "[Cd.305] Command generation axis positioning data setting value" is written to the positioning data of the command generation axis positioning data No. specified in "[Cd.303] Command generation axis positioning data No. designation" and "[Cd.304] Command generation axis positioning data designation". When the writing is succeeded, "0: Not request" is set in "[Cd.306] Command generation axis positioning data control request".
- (5) When the positioning data No. and the positioning data which are not defined to the command generation axis are specified, "FFFFH: Write error" is set in "[Cd.306] Command generation axis positioning data control request". "[Cd.306] Command generation axis positioning data control request" is detected always. It is not required to return to "0: Not request" from "FFFFH: Write error" manually.
- (6) The command generation axis control data and positioning data written by this method are erased at the power supply OFF. When it is necessary to save the data, write to the flash ROM of the Simple Motion module by "[Cd.1] Flash ROM write request".

The timing that the command generation axis positioning data to be written becomes valid is common with the servo amplifier axis. For specification details, refer to the "User's Manual (Positioning Control)" of each Simple Motion module.

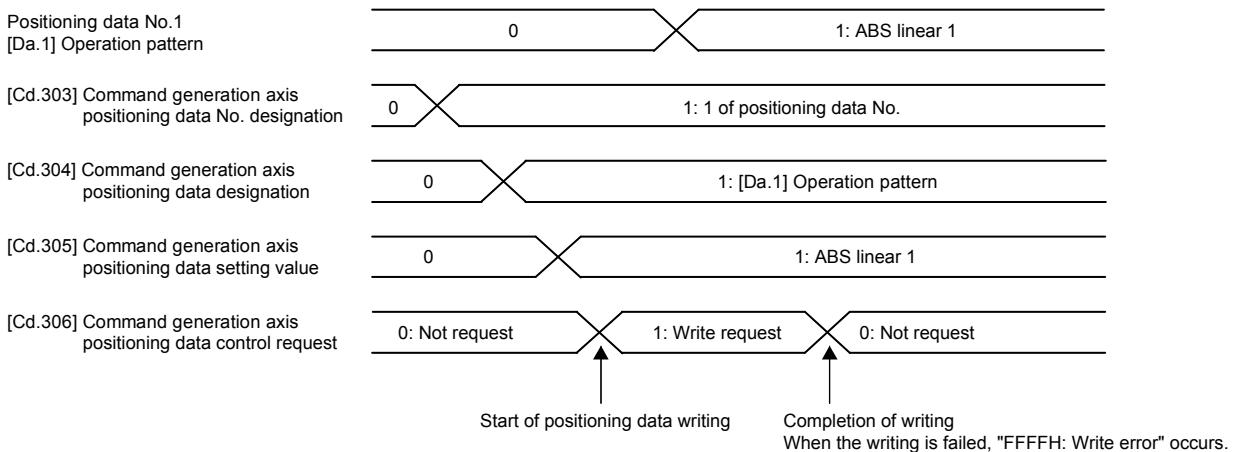

[4] Read method for command generation axis positioning data

- (1) Specify the command generation axis positioning data No. to "[Cd.303] Command generation axis positioning data No. designation". When "1" is set, "1" of the positioning data is specified.
- (2) Specify the command generation axis positioning data [Da.\_] to "[Cd.304] Command generation axis positioning data designation". When "1" is set, "[Da.1] Operation pattern" is specified.
- (3) Set "2: Read request" to "[Cd.306] Command generation axis positioning data control request".
- (4) "[Cd.305] Command generation axis positioning data setting value" is read with 2 words to the positioning data of the command generation axis positioning data No. specified in "[Cd.303] Command generation axis positioning data No. designation" and "[Cd.304] Command generation axis positioning data designation". When the reading is succeeded, "0: Not request" is set in "[Cd.306] Command generation axis positioning data control request".
- (5) When the parameter No. which is not defined to the command generation axis is specified, "FFFFH: Write error" is set in "[Cd.306] Command generation axis positioning data control request". "[Cd.306] Command generation axis positioning data control request" is detected always. It is not required to return to "0: Not request" from "FFFFH: Write error" manually.

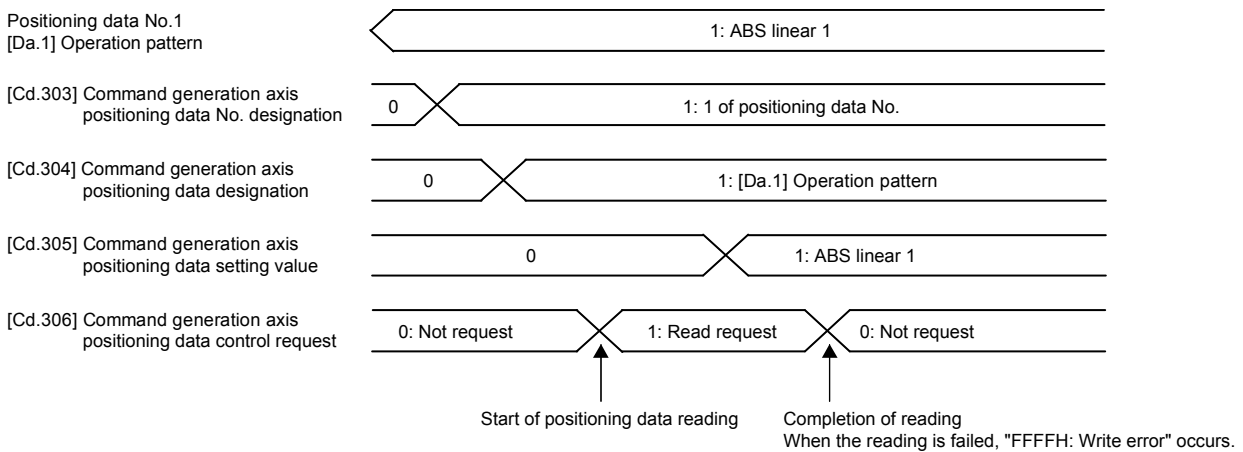

## 2.3 Synchronous encoder axis

### 2.3.1 Overview of synchronous encoder axis

The synchronous encoder is used to drive the input axis based on input pulse from a synchronous encoder that is connected externally.

The status of a synchronous encoder axis can also be monitored after the system's power supply turns ON.

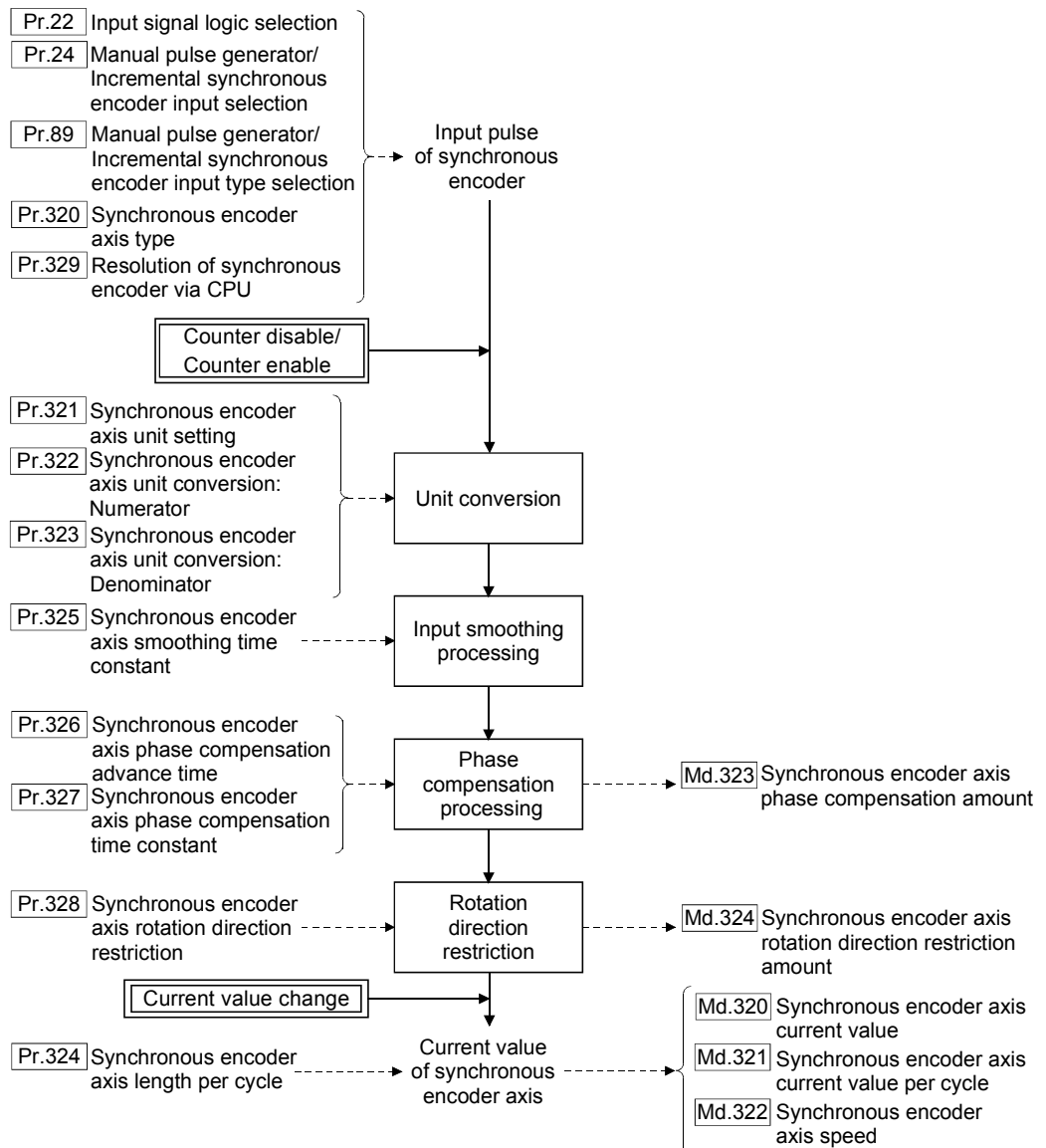

### ■ Synchronous encoder axis type

The following 3 types of synchronous encoders can be used for the synchronous encoder axis.

Refer to Section 2.3.2 for the setting method for each synchronous encoder axis.

Synchronous encoder axis type	Details
Incremental synchronous encoder	The incremental synchronous encoder that is connected to the manual pulse generator/incremental synchronous encoder input of the Simple Motion module is used as the synchronous encoder axis.
Synchronous encoder via servo amplifier <b>QD77MS</b> <b>LD77MS</b> <b>QD77GF</b> [CiA402 mode]	Used to use a synchronous encoder connected to the servo amplifier which supports the scale measurement mode as a synchronous encoder axis.
Synchronous encoder via CPU	Used to operate a gray code encoder that is connected to the input module of PLC CPU as a synchronous encoder axis.

### ■ Control method for synchronous encoder axis

The following controls can be executed for the synchronous encoder axis by using "[Cd.320] Synchronous encoder axis control start" and "[Cd.321] Synchronous encoder axis control method".

Setting value of "[Cd.321] Synchronous encoder axis control method"	Control details
0: Current value change	"[Md.320] Synchronous encoder axis current value" and "[Md.321] Synchronous encoder axis current value per cycle" are changed based on the setting of "[Cd.322] Synchronous encoder axis current value setting address".
1: Counter disable	Input from the synchronous encoder is disabled.
2: Counter enable	Input from the synchronous encoder is enabled.

■ Units for the synchronous encoder axis

The position units and speed units for the synchronous encoder axis are shown below for the setting of "[Pr.321] Synchronous encoder axis unit setting".

Table 2.3 Synchronous encoder axis position units

Setting value of "[Pr.321] Synchronous encoder axis unit setting"		Synchronous encoder axis position unit	Range
Control unit	Number of decimal places for position		
0: mm	0	mm	-2147483648 to 2147483647 [mm]
	⋮	⋮	⋮
	9	$\times 10^{-9}$ mm	-2.147483648 to 2.147483647 [mm]
1: inch	0	inch	-2147483648 to 2147483647 [inch]
	⋮	⋮	⋮
	9	$\times 10^{-9}$ inch	-2.147483648 to 2.147483647 [inch]
2: degree	0	degree	-2147483648 to 2147483647 [degree]
	⋮	⋮	⋮
	9	$\times 10^{-9}$ degree	-2.147483648 to 2.147483647 [degree]
3: PLS	0	PLS	-2147483648 to 2147483647 [PLS]
	⋮	⋮	⋮
	9	$\times 10^{-9}$ PLS	-2.147483648 to 2.147483647 [PLS]

Table 2.4 Synchronous encoder axis speed units

Setting value of "[Pr.321] Synchronous encoder axis unit setting"			Synchronous encoder axis speed unit	Range
Control unit	Speed time unit	Number of decimal places for speed		
0: mm	0: second [s]	0	mm/s	-2147483648 to 2147483647 [mm/s]
		⋮	⋮	⋮
		9	$\times 10^{-9}$ mm/s	-2.147483648 to 2.147483647 [mm/s]
	1: minute [min]	0	mm/min	-2147483648 to 2147483647 [mm/min]
		⋮	⋮	⋮
		9	$\times 10^{-9}$ mm/min	-2.147483648 to 2.147483647 [mm/min]
1: inch	0: second [s]	0	inch/s	-2147483648 to 2147483647 [inch/s]
		⋮	⋮	⋮
		9	$\times 10^{-9}$ inch/s	-2.147483648 to 2.147483647 [inch/s]
	1: minute [min]	0	inch/min	-2147483648 to 2147483647 [inch/min]
		⋮	⋮	⋮
		9	$\times 10^{-9}$ inch/min	-2.147483648 to 2.147483647 [inch/min]
2: degree	0: second [s]	0	degree/s	-2147483648 to 2147483647 [degree/s]
		⋮	⋮	⋮
		9	$\times 10^{-9}$ degree/s	-2.147483648 to 2.147483647 [degree/s]
	1: minute [min]	0	degree/min	-2147483648 to 2147483647 [degree/min]
		⋮	⋮	⋮
		9	$\times 10^{-9}$ degree/min	-2.147483648 to 2.147483647 [degree/min]
3: PLS	0: second [s]	0	PLS/s	-2147483648 to 2147483647 [PLS/s]
		⋮	⋮	⋮
		9	$\times 10^{-9}$ PLS/s	-2.147483648 to 2.147483647 [PLS/s]
	1: minute [min]	0	PLS/min	-2147483648 to 2147483647 [PLS/min]
		⋮	⋮	⋮
		9	$\times 10^{-9}$ PLS/min	-2.147483648 to 2.147483647 [PLS/min]

## 2.3.2 Setting method for synchronous encoder

### [1] Incremental synchronous encoder

#### ■ Setting method

Connect the synchronous encoder to the "Manual pulse generator/Incremental synchronous encoder input" of the Simple Motion module.

Set the input method for the incremental synchronous encoder signal using the following parameters. (It may be common to use the same set up for the manual pulse generator input.)

- "[Pr.22] Input signal logic selection"
- "[Pr.24] Manual pulse generator/Incremental synchronous encoder input selection"
- "[Pr.89] Manual pulse generator/Incremental synchronous encoder input type selection"

POINT
<p>The synchronous encoder axis operates completely independently with the manual pulse generator operation.</p> <p>The parameter and control data for the manual pulse generator operation except the 3 parameters listed above has not influence on control of synchronous encoder axis. Therefore, they can also be controlled simultaneously by common input pulses.</p>

When the synchronous encoder axis connection is valid after the system's power supply is ON, it will be "Synchronous encoder axis current value=0", "Synchronous encoder axis current value per cycle=0" and "Counter enabling status".



■ Setting example

The following shows an example for setting an incremental synchronous encoder as synchronous encoder axis 2 of the QD77MS.

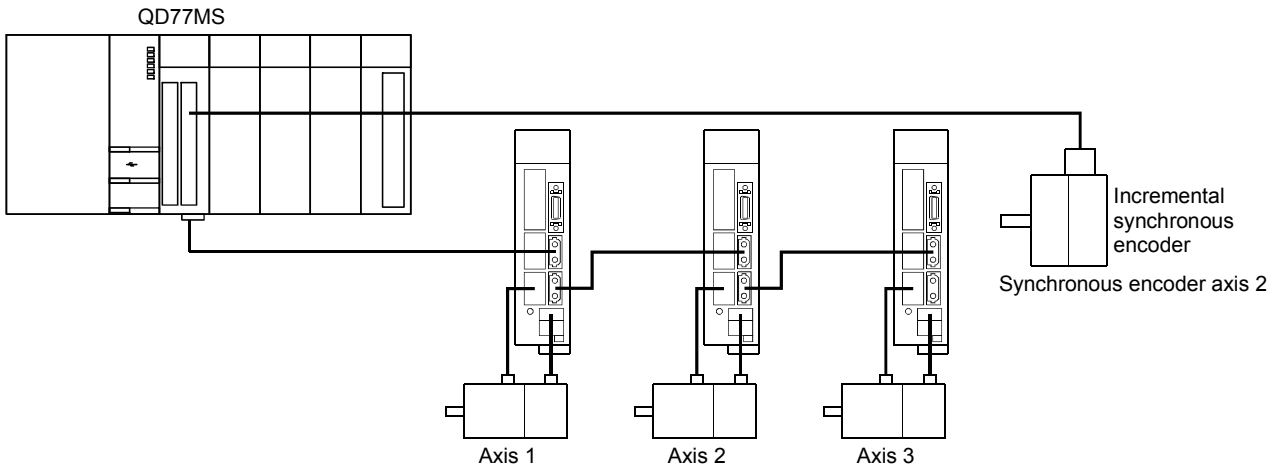

Set "1: Incremental synchronous encoder" in "[Pr.320] Synchronous encoder axis type" for the synchronous encoder axis 2.

And, set the input method for incremental synchronous encoder signal in the following parameters.

- "[Pr.22] Input signal logic selection" Manual pulse generator input (b8)  
..... "0: Negative logic"
- "[Pr.24] Manual pulse generator/Incremental synchronous encoder input selection"  
..... "0: A-phase/B-phase multiplied by 4"
- "[Pr.89] Manual pulse generator/Incremental synchronous encoder input type selection"  
..... "0: Differential output type"

## [2] Synchronous encoder via servo amplifier

**QD77MS** **LD77MS** **QD77GF** [CiA402 mode]

There are restrictions in the function and the encoder that can be used by the version of the servo amplifier.

■ Setting method

Used to use a synchronous encoder connected to the servo amplifier which supports the scale measurement mode as a synchronous encoder axis.

The following servo amplifier can be used. The servo amplifier must support the scale measurement function.

- MR-J4-B-RJ **QD77MS** **LD77MS**
- MR-J4-GF-RJ **QD77GF** [CiA402 mode]

Only a rotary encoder can be connected. Refer to the following servo amplifier instruction manuals for the version of the servo amplifier which supports the scale measurement function and the rotary encoder which can be used.

- SSCNETⅢ/H Interface AC Servo MR-J4-\_B\_(-RJ) Servo Amplifier Instruction Manual  
**QD77MS** **LD77MS**
- MR-J4-\_GF\_(-RJ) Servo Amplifier Instruction Manual (Motion Mode)  
**QD77GF** [CiA402 mode]

A synchronous encoder connected to the specified servo amplifier axis can be used by the following settings.

Setting item	Setting method
Synchronous encoder axis setting	<p>Set "101 to 116: Synchronous encoder via servo amplifier (Connectable servo amplifier: axis 1 to axis 16 <sup>(Note-1)</sup>)" in "[Pr.320] Synchronous encoder axis type".</p> <p>[Setting method of Simple Motion Module Setting Tool]</p> <p>Set the synchronous encoder axis parameter according to the setting below.</p> <ul style="list-style-type: none"> <li>• "[Pr.320] Type" <ul style="list-style-type: none"> <li>101: Synchronous encoder via servo amplifier</li> </ul> </li> <li>• "[Pr.320] Axis No. of connected servo amplifier" <ul style="list-style-type: none"> <li>Axis No. of servo amplifier to connect</li> </ul> </li> </ul>
Encoder type setting (Absolute/Incremental)	<p>Set the servo parameter "Scale measurement mode selection (PA22)" according to the setting below.</p> <p>0 ___ h: Disabled 1 ___ h: Used in absolute position detection system 2 ___ h: Used in incremental system</p> <p>[Setting method of Simple Motion Module Setting Tool] <b>QD77MS</b> <b>LD77MS</b></p> <p>Set "ABS" or "INC" from the "External synchronous encoder input" list of the amplifier setting dialog. (The amplifier setting dialog can be opened from the system structure screen in the system setting.)</p>

(Note-1): The range from axis 1 to 2 is valid in the 2-axis module, from axis 1 to 4 is valid in the 4-axis module, from axis 1 to 8 is valid in the 8-axis module, and from axis 1 to 16 is valid in the 16-axis module.

When "1 \_\_\_ h" is set in the servo parameter "Scale measurement mode selection (PA22)", the synchronous encoder axis current value and the synchronous encoder axis current value per cycle are restored after the servo amplifier axis is connected. Therefore, connection becomes valid, and will be on the counter enabling status. (The current value setting by current value change is required beforehand.)

When "2 \_\_\_ h" is set in the servo parameter "Scale measurement mode selection (PA22)", "0" is set to the initial value of the synchronous encoder axis current value and the synchronous encoder axis current value per cycle after the servo amplifier axis is connected. Therefore, connection becomes valid, and will be on the counter enabling status.

If the corresponding servo amplifier axis is not connected, the connection of the synchronous encoder axis will be invalid.

POINT
When "1 ___ h" is set in the servo parameter "Scale measurement mode selection (PA22)" and the synchronous encoder movement amount (encoder pulse units) on disconnection or during the power supply OFF exceeds "2147483647" or "-2147483648", the synchronous encoder axis current value is restored with its opposite sign.

■ Points of the setting method

- "Scale measurement mode selection (PA22)" is set to the servo amplifier set by "ABS" or "INC" from the "External synchronous encoder input" list of the amplifier setting dialog using the Simple Motion Module Setting Tool. QD77MS LD77MS
- When the servo parameter "Scale measurement mode selection (PA22)" is changed, it is required to switch the power of servo amplifier off once after the parameter is transferred to the servo amplifier, and then switch it on again.
- If the servo amplifier set by the servo parameter "Scale measurement mode selection (PA22)" does not support the "Scale measurement mode", "AL.37" (parameter error) will occur in the servo amplifier. Refer to the servo amplifier instruction manual for details of the servo parameter "Scale measurement mode selection (PA22)".
- The synchronous encoder via servo amplifier can be controlled up to 4. However, there is no restriction for the number of connections. Therefore, the error check is not executed even when the external synchronous encoders are set more than 4 on the system setting screen using the Simple Motion Module Setting Tool. QD77MS LD77MS
- The following information of the synchronous encoder via servo amplifier can be output with the optional data monitor. The setting details of the optional data monitor for the synchronous encoder information are shown below. QD77MS LD77MS

Information of synchronous encoder	Setting detail for optional data monitor
Scale position within one-revolution	24: Load side encoder information 1 (Used point: 2words)
Scale absolute counter	25: Load side encoder information 2 (Used point: 2words)

- A serial absolute synchronous encoder Q171ENC-W8 can be used in an incremental system by setting "2 \_\_\_ h" in the servo parameter "Scale measurement mode selection (PA22)" even if the battery of the servo amplifier is dismantled.

### ■ Setting example

The following shows an example for setting a serial absolute synchronous encoder Q171ENC-W8 using MR-J4-B-RJ as synchronous encoder axis 1 of the QD77MS.

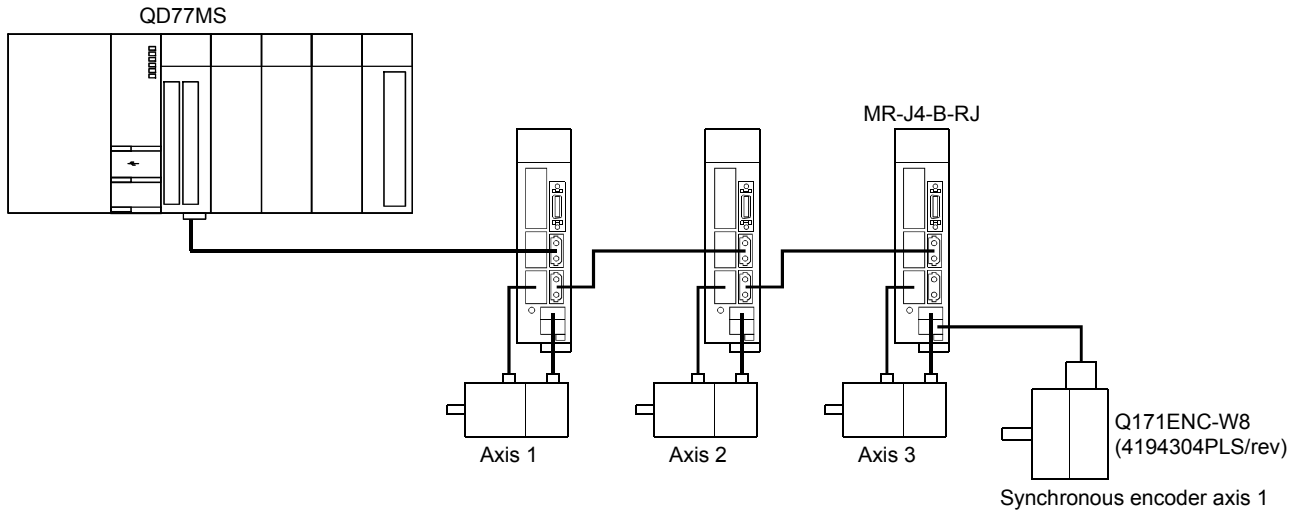

Set the parameters as below.

- Set "101: Synchronous encoder via servo amplifier (servo amplifier axis 3)" in "[Pr.320] Synchronous encoder axis type" of synchronous encoder axis 1.
- Set MR-J4 series in "[Pr.100] Servo series" of the axis to connect Q171ENC-W8.
- Set "1 \_\_\_ h" or "2 \_\_\_ h" in the servo parameter "Scale measurement mode selection (PA22)". (Set "ABS" or "INC" from the "External synchronous encoder input" list of the amplifier setting dialog using the Simple Motion Module Setting Tool.) **QD77MS** **LD77MS**
- Set "1 \_\_\_ h" in the servo parameter "Function selection C-8 (PC26)".

### ■ Restrictions

- (1) The servo amplifier axis selected as "Synchronous encoder via servo amplifier" in "[Pr.320] Synchronous encoder axis type" does not operate in the fully closed control mode even though "\_ \_ 1 \_" is set in the servo parameter "Operation mode selection (PA01)".
- (2) The information about the synchronous encoder is output to "[Md.112] Optional data monitor output 4" of the servo amplifier axis selected as "Synchronous encoder via servo amplifier" in "[Pr.320] Synchronous encoder axis type", and "[Pr.94] Optional data monitor: Data type setting 4" is ignored.  
(Set the total points to be within 3 words for the optional data monitor. Otherwise, the monitor setting is ignored.) **QD77MS** **LD77MS**
- (3) When the servo alarms about the serial absolute synchronous encoder connection occur in the servo amplifier axis selected as "Synchronous encoder via servo amplifier" in "[Pr.320] Synchronous encoder axis type", the status becomes servo OFF. "AL.25" (Absolute position erased), "AL.70" (Load-side encoder initial communication error 1), or "AL.71" (Load-side encoder normal communication error 1) occurs in the servo amplifier.
- (4) The error "Synchronous encoder via servo amplifier invalid error" (error code: 979) occurs in the following cases.
  - Other than MR-J4 series is set in "[Pr.100] Servo series" of the axis No. selected as "Synchronous encoder via servo amplifier" in "[Pr.320] Synchronous encoder axis type". **QD77MS** **LD77MS**
  - The servo amplifier axis which is not set in the system setting is set to the servo amplifier axis No. to connect to "Synchronous encoder via servo amplifier". **QD77MS** **LD77MS**
  - The servo axis, which "Invalid" is set to from the "External synchronous encoder input" list of the amplifier setting dialog using the Simple Motion Module Setting Tool, is set to the servo amplifier axis No. to connect to "Synchronous encoder via servo amplifier". **QD77MS** **LD77MS**
  - A linear scale is connected.
  - The servo amplifier of the axis No. selected as "Synchronous encoder via servo amplifier" in "[Pr.320] Synchronous encoder axis type" is not set or the servo axis, which scale measurement mode is not enabled, is set to the servo amplifier axis No. to connect to "Synchronous encoder via servo amplifier". **QD77GF** [CiA402 mode]

### [3] Synchronous encoder via CPU (Synchronous encoder via PLC CPU)

#### ■ Setting method

Used to operate a gray code encoder that is connected to the input module of the PLC CPU as a synchronous encoder axis.

By setting "201: Synchronous encoder via CPU" in "[Pr.320] Synchronous encoder axis type", the synchronous encoder is controlled by the encoder value which is the input value of "[Cd.325] Input value for synchronous encoder via CPU".

The encoder value can be used as a cycle counter within the range from 0 to (Resolution of synchronous encoder via CPU - 1).

Connection is invalid just after the system's power supply is ON. When "1" is set in "[Cd.324] Connection command of synchronous encoder via CPU", the synchronous encoder axis current value and the synchronous encoder axis current value per cycle are restored based on "[Cd.325] Input value for synchronous encoder via CPU". Therefore, connection becomes valid, and will be on the counter enabling status.

The synchronous encoder axis is controlled based on the amount of change of "[Cd.325] Input value for synchronous encoder via CPU" while it is connecting.

#### ■ Setting example

The following shows an example for setting a synchronous encoder via CPU as synchronous encoder axis 4 of the QD77MS.

(Resolution of the gray code encoder: 4096 PLS/rev)

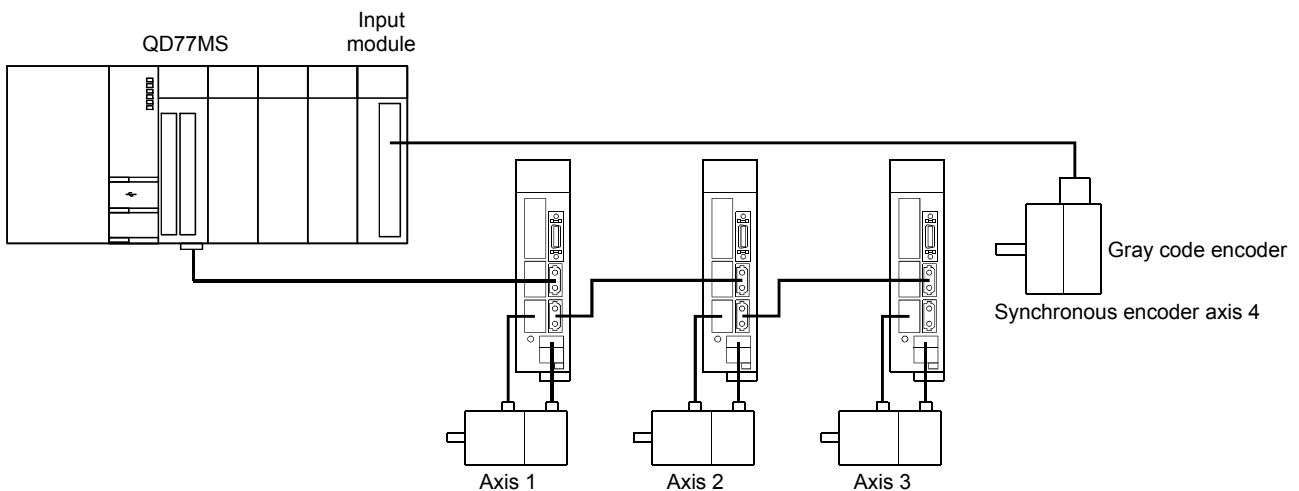

Set "201: Synchronous encoder via CPU" in "[Pr.320] Synchronous encoder axis type" of synchronous encoder axis 4.

Set "4096" in "[Pr.329] Resolution of synchronous encoder via CPU" of synchronous encoder axis 4.

Read the encoder value of the gray code encoder with a program, and update "[Cd.325] Input value for synchronous encoder via CPU" of the synchronous encoder axis 4 at every time.

### ■ Restrictions

- (1) "[Cd.325] Input value for synchronous encoder via CPU" is taken every operation cycle, but it is asynchronous with the scan time of the PLC CPU. Therefore, speed fluctuation of the synchronous encoder axis becomes larger if the refresh cycle of "[Cd.325] Input value for synchronous encoder via CPU" becomes long. Update "[Cd.325] Input value for synchronous encoder via CPU" in a cycle less than the operation cycle or use smooth speed fluctuation with the smoothing function.
- (2) The synchronous encoder current value that is restored for the synchronous encoder connection gets restored into a converted value from the following range based on the synchronous encoder travel value on disconnection.

Setting value of "[Pr.329] Resolution of synchronous encoder via CPU"	Range of restored synchronous encoder current value
1 or more	-(Resolution of synchronous encoder via CPU/2) to (Resolution of synchronous encoder via CPU/2-1) [PLS] (Note): If the resolution of a synchronous encoder via CPU is an odd number, round down a negative value after the decimal point, round up a positive value after decimal point.
0 or less	-2147483648 to 2147483647 [PLS]

## 2.3.3 Synchronous encoder axis parameters

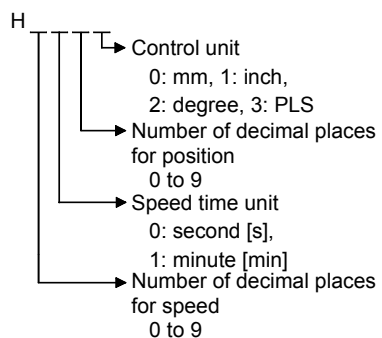
Setting item	Setting details	Setting value	Default value	Buffer memory address
[Pr.320] Synchronous encoder axis type	<ul style="list-style-type: none"> <li>Set the synchronous encoder axis type to be used.</li> </ul> Fetch cycle: At power supply ON	<ul style="list-style-type: none"> <li>Set in decimal.</li> <li>0 : Invalid</li> <li>1 : Incremental synchronous encoder</li> <li>101 to 116 : Synchronous encoder via servo amplifier (Connectable servo amplifier: Axis 1 to axis 16 (Note-1))               <ul style="list-style-type: none"> <li>QD77MS LD77MS</li> <li>QD77GF [CiA402 mode]</li> </ul> </li> <li>201 : Synchronous encoder via CPU</li> </ul>	0	34720+20j
[Pr.321] Synchronous encoder axis unit setting	<ul style="list-style-type: none"> <li>Set the unit of the synchronous encoder axis.</li> <li>Set the position unit within the range from <math>\times 1</math> to <math>10^{-9}</math> [control unit].</li> <li>Set the speed unit within the range from <math>\times 1</math> to <math>10^{-9}</math> [control unit/s or control unit/min].</li> </ul> Fetch cycle: At power supply ON	<ul style="list-style-type: none"> <li>Set in hexadecimal.</li> </ul>  <p>Control unit 0: mm, 1: inch, 2: degree, 3: PLS</p> <p>Number of decimal places for position 0 to 9</p> <p>Speed time unit 0: second [s], 1: minute [min]</p> <p>Number of decimal places for speed 0 to 9</p>	0003h	34721+20j
[Pr.322] Synchronous encoder axis unit conversion: Numerator	<ul style="list-style-type: none"> <li>Set the numerator to convert the unit from the encoder pulse of the synchronous encoder axis into the synchronous encoder axis unit.</li> </ul> Fetch cycle: At power supply ON	<ul style="list-style-type: none"> <li>Set in decimal.</li> <li>-2147483648 to 2147483647 [Synchronous encoder axis position units (Note-2)]</li> </ul>	1	34722+20j 34723+20j
[Pr.323] Synchronous encoder axis unit conversion: Denominator	<ul style="list-style-type: none"> <li>Set the denominator to convert the unit from the encoder pulse of the synchronous encoder axis into the synchronous encoder axis unit.</li> </ul> Fetch cycle: At power supply ON	<ul style="list-style-type: none"> <li>Set in decimal.</li> <li>1 to 2147483647 [PLS]</li> </ul>	1	34724+20j 34725+20j
[Pr.324] Synchronous encoder axis length per cycle	<ul style="list-style-type: none"> <li>Set the length per cycle of the synchronous encoder axis.</li> </ul> Fetch cycle: At power supply ON	<ul style="list-style-type: none"> <li>Set in decimal.</li> <li>1 to 2147483647 [Synchronous encoder axis position units (Note-2)]</li> </ul>	4000	34726+20j 34727+20j
[Pr.325] Synchronous encoder axis smoothing time constant	<ul style="list-style-type: none"> <li>Set the time to smooth for the input value.</li> </ul> Fetch cycle: At power supply ON	<ul style="list-style-type: none"> <li>Set in decimal.</li> <li>0 to 5000 [ms]</li> </ul>	0	34728+20j

j: Synchronous encoder axis No.-1

(Note-1): The range from axis 1 to 2 is valid in the 2-axis module, from axis 1 to 4 is valid in the 4-axis module, from axis 1 to 8 is valid in the 8-axis module, and from axis 1 to 16 is valid in the 16-axis module.

(Note-2): Synchronous encoder axis position units (Refer to Section 2.3.1)



Setting item	Setting details	Setting value	Default value	Buffer memory address
[Pr.326] Synchronous encoder axis phase compensation advance time	<ul style="list-style-type: none"> <li>Set the time to advance or delay the phase.</li> </ul> <u>Fetch cycle: Operation cycle</u>	<ul style="list-style-type: none"> <li>Set in decimal.</li> </ul> -2147483648 to 2147483647 [ $\mu$ s]	0	34730+20j 34731+20j
[Pr.327] Synchronous encoder axis phase compensation time constant	<ul style="list-style-type: none"> <li>Set the time constant to affect the phase compensation.</li> </ul> <u>Fetch cycle: At power supply ON</u>	<ul style="list-style-type: none"> <li>Set in decimal.</li> </ul> 0 to 65535 [ms] <sup>(Note-3)</sup>	10	34732+20j
[Pr.328] Synchronous encoder axis rotation direction restriction	<ul style="list-style-type: none"> <li>Set this parameter to restrict the input travel value to one direction.</li> </ul> <u>Fetch cycle: At power supply ON</u>	<ul style="list-style-type: none"> <li>Set in decimal.</li> </ul> 0: Without rotation direction restriction 1: Enable only for current value increase direction 2: Enable only for current value decrease direction	0	34733+20j
[Pr.329] Resolution of synchronous encoder via CPU	<ul style="list-style-type: none"> <li>Set the resolution of the synchronous encoder when the synchronous encoder axis type is set to synchronous encoder via CPU.</li> <li>If 0 or less is set, the input value of synchronous encoder via CPU is processed as 32-bit counter.</li> </ul> <u>Fetch cycle: At power supply ON</u>	<ul style="list-style-type: none"> <li>Set in decimal.</li> </ul> -2147483648 to 2147483647 [PLS]	0	34734+20j 34735+20j

j: Synchronous encoder axis No.-1

(Note-3): Set the value as follows in a program.

0 to 32767 ..... Set as a decimal

32768 to 65535 ..... Convert into a hexadecimal and set

[Pr.320] Synchronous encoder axis type

Set the synchronous encoder type to be generated of the input value for the synchronous encoder axis.

- 0: Invalid.....Synchronous encoder axis is invalid.
- 1: Incremental synchronous encoder .....Generate the input value based on the incremental synchronous encoder input.

101 to 116: Synchronous encoder via servo amplifier  
(Connectable servo amplifier: Axis 1 to axis 16 <sup>(Note-1)</sup>)

**QD77MS** **LD77MS** **QD77GF** [CiA402 mode]

.....Generate the input value based on the synchronous encoder input via servo amplifier connected to the specified servo amplifier (axis 1 to axis 16).

201: Synchronous encoder via CPU .....Generate the input value with the value set in the buffer memory by the PLC CPU as the encoder value.

(Note-1): The range from axis 1 to 2 is valid in the 2-axis module, from axis 1 to 4 is valid in the 4-axis module, from axis 1 to 8 is valid in the 8-axis module, and from axis 1 to 16 is valid in the 16-axis module.

[Pr.321] Synchronous encoder axis unit setting

Set the position and speed unit of the synchronous encoder axis. Refer to Section 2.3.1 for details.

[Pr.322] Synchronous encoder axis unit conversion: Numerator,

[Pr.323] Synchronous encoder axis unit conversion: Denominator

The input travel value of synchronous encoder is configured in encoder pulse units. The units can be arbitrarily converted through unit conversation with setting [Pr.322] and [Pr.323]. Set [Pr.322] and [Pr.323] according to the controlled machine.

$$\begin{array}{l} \text{Synchronous encoder axis} \\ \text{travel value (Travel value} \\ \text{after unit conversion)} \end{array} = \begin{array}{l} \text{Synchronous encoder} \\ \text{input travel value} \\ \text{(Encoder pulse units)} \end{array} \times \frac{\text{"[Pr.322] Synchronous encoder axis unit} \\ \text{conversion: Numerator"}}{\text{"[Pr.323] Synchronous encoder axis unit} \\ \text{conversion: Denominator"}}$$

The travel value corresponding to "[Pr.323] Synchronous encoder axis unit conversion: Denominator" is set in "[Pr.322] Synchronous encoder axis unit conversion: Numerator" in synchronous encoder axis position units (Refer to Section 2.3.1).

The input travel value can be reversed by the setting negative values.

Set "[Pr.323] Synchronous encoder axis unit conversion: Denominator" based on encoder pulse units from the synchronous encoder.

Set a value within the range from 1 to 2147483647.

[Pr.324] Synchronous encoder axis length per cycle

Set the length per cycle for the synchronous encoder axis current value per cycle.

The current value of synchronous encoder axis is stored in "[Md.321] Synchronous encoder axis current value per cycle" at ring counter based on the setting value.

The unit settings are in synchronous encoder axis position units (Refer to Section 2.3.1).

Set a value within the range from 1 to 2147483647.

Example) Setting example of the unit conversion and the length per cycle.

The following shows an example a rotary encoder is connected which resolution is 4000[PLS/rev] to the motor axis side on the rotation table that drives by 1/5 pulley system, and the control unit is degree.

- Position unit : 0.1 [degree]
- Speed unit : 0.001 [degree/min]
- Length per cycle : 360.0 [degree] (1 cycle of the rotation table)

Setting item		Setting details	Setting value
[Pr.321] Synchronous encoder axis unit setting	Control unit	2: degree	3112h
	Number of decimal places for position	1	
	Speed time unit	1: minute [min]	
	Number of decimal places for speed	3	
[Pr.322] Synchronous encoder axis unit conversion: Numerator		360.0 [degree] × 1	3600 [×0.1 degree]
[Pr.323] Synchronous encoder axis unit conversion: Denominator		4000 [PLS] × 5	20000 [PLS]
[Pr.324] Synchronous encoder axis length per cycle		360.0 [degree]	3600 [×0.1 degree]

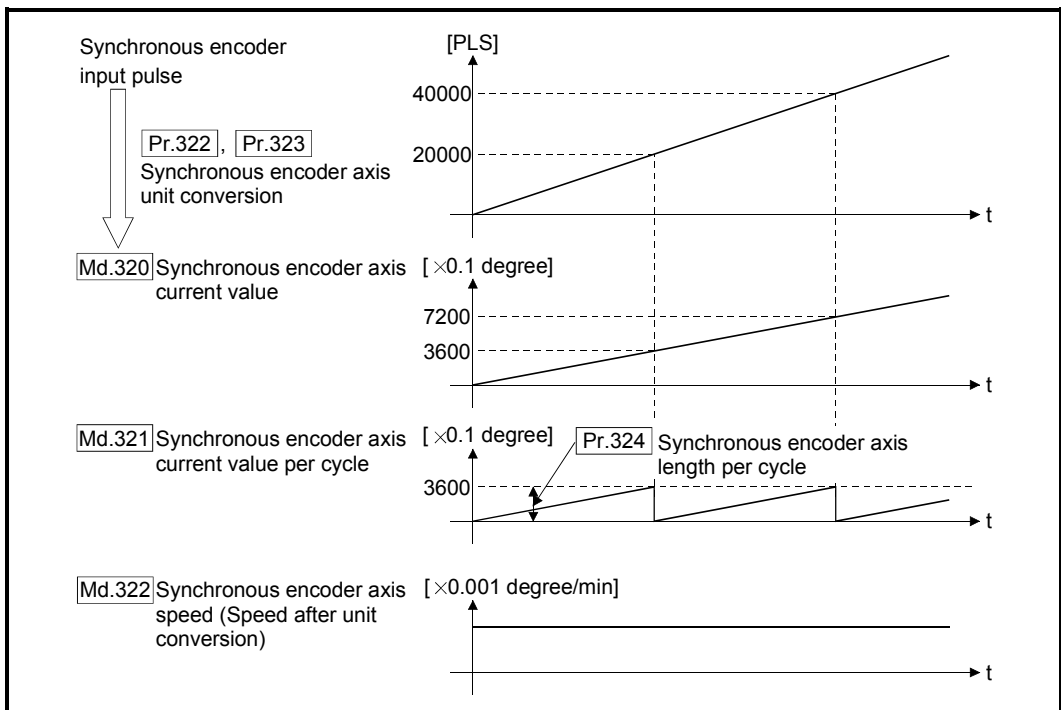

[Pr.325] Synchronous encoder axis smoothing time constant

Set the averaging time to execute a smoothing process for the input travel value from synchronous encoder.

The smoothing process can moderate speed fluctuation of the synchronous encoder input. The input response is delayed depending on the time corresponding to the setting by smoothing process setting.

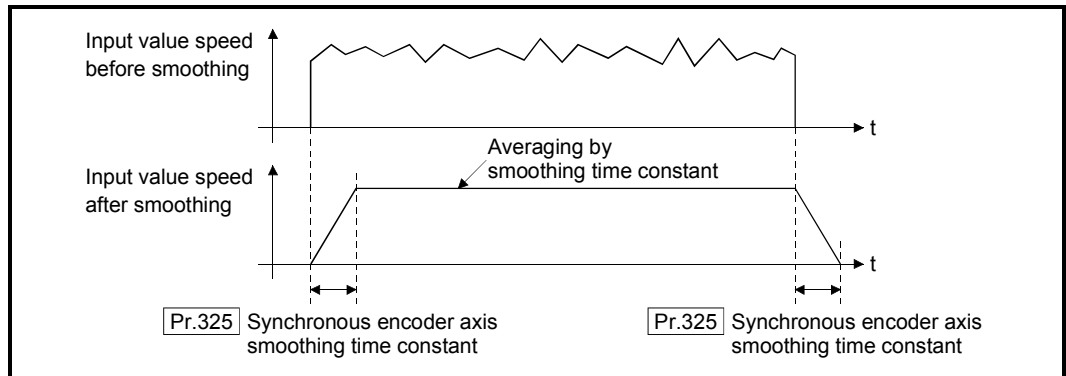

[Pr.326] Synchronous encoder axis phase compensation advance time

Set the time to advance or delay the phase (input response) of the synchronous encoder axis.

Refer to Section 4.8 "Phase compensation function" for the peculiar time delay of the system using the synchronous encoder axis.

1 to 2147483647 [ $\mu$ s]..... Advance the phase (input response) according to the setting time.

0 [ $\mu$ s] ..... Do not execute phase compensation.

-2147483648 to -1 [ $\mu$ s] ..... Delay the phase (input response) according to the setting time.

If the setting time is too long, the system experiences overshoot or undershoot at acceleration/deceleration of the input speed. In this case, set a longer time to affect the phase compensation amount in "[Pr.327] Synchronous encoder axis phase compensation time constant".

[Pr.327] Synchronous encoder axis phase compensation time constant

Set the time constant to affect the phase compensation amount for the first order delay.  
63 [%] of the phase compensation amount are reflected in the time constant setting.

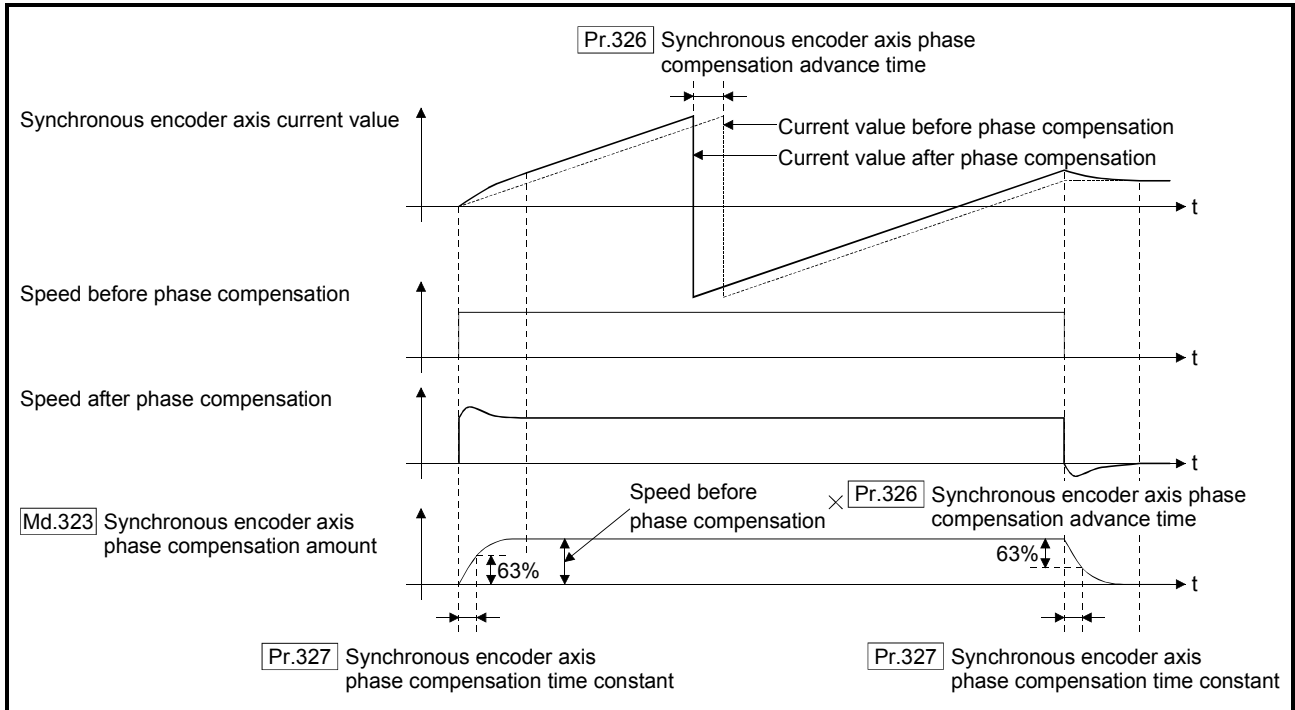

[Pr.328] Synchronous encoder axis rotation direction restriction

Set this parameter to restrict the input travel value for the synchronous encoder axis to one direction.

This helps to avoid reverse operation caused by such as machine vibration of synchronous encoder input.

- 0: Without rotation direction restriction .....Rotation direction restriction is not executed.
- 1: Enable only for current value increase direction .....Enable only the input travel value in the increasing direction of the synchronous encoder axis current value.
- 2: Enable only for current value decrease direction .....Enable only the input travel value in the decreasing direction of the synchronous encoder axis current value.

The input travel value in the opposite direction of the enabled direction accumulates as a rotation direction restricted amount, and it will be reflected when the input travel value moves in the enabled direction again. Therefore, the current value of synchronous encoder axis does not deviate when the reverse operation is repeated.

The rotation direction restricted amount is set to 0 at the synchronous encoder axis connection and current value change.

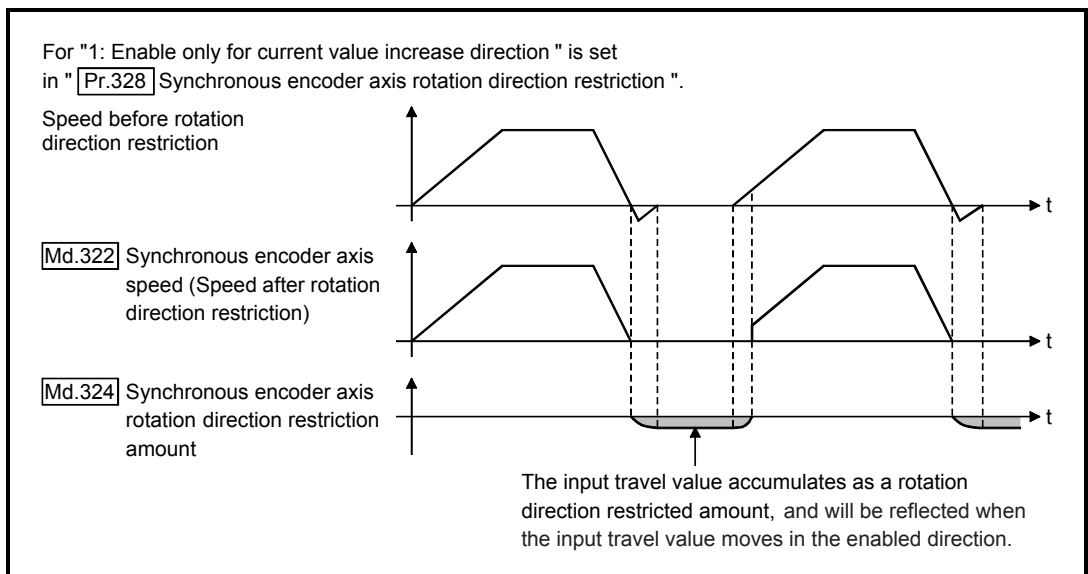

**[Pr.329] Resolution of synchronous encoder via CPU**

Set the resolution of connected synchronous encoder when "201: Synchronous encoder via CPU" is set in "[Pr.320] Synchronous encoder axis type".

If 1 or more is set, "[Cd.325] Input value for synchronous encoder via CPU" is processed as the cycle counter within the range from 0 to (resolution of synchronous encoder via CPU - 1).

If 0 or less is set, "[Cd.325] Input value for synchronous encoder via CPU" is processed as 32 bit counter within the range from -2147483648 to 2147483647.

<b>POINT</b>
--------------

If 1 or more is set in "[Pr.329] Resolution of synchronous encoder via CPU", set the cycle counter within the range from 0 to (resolution of synchronous encoder via CPU - 1) as the input value in "[Cd.325] Input value for synchronous encoder via CPU".
---

## 2.3.4 Synchronous encoder axis control data

Setting item	Setting details	Setting value	Default value	Buffer memory address
[Cd.320] Synchronous encoder axis control start	<ul style="list-style-type: none"> <li>If set to "1", the synchronous encoder axis control is started.</li> <li>If set to "101 to 116", the synchronous encoder axis control starts based on the high-speed input request (external command signal).</li> <li>The Simple Motion module resets the value to "0" automatically after completion of the synchronous encoder axis control.</li> </ul> Fetch cycle: <u>Operation cycle</u>	<ul style="list-style-type: none"> <li>Set in decimal.</li> <li>1 : Start for synchronous encoder axis control</li> <li>101 to 116 : High-speed input start for synchronous encoder axis control (axis 1 to axis 16 <sup>(Note-2)</sup>)</li> </ul>	0	35040+10j
[Cd.321] Synchronous encoder axis control method	<ul style="list-style-type: none"> <li>Set the control method for the synchronous encoder axis.</li> </ul> Fetch cycle: <u>At synchronous encoder axis control start</u>	<ul style="list-style-type: none"> <li>Set in decimal.</li> <li>0: Current value change</li> <li>1: Counter disable</li> <li>2: Counter enable</li> </ul>	0	35041+10j
[Cd.322] Synchronous encoder axis current value setting address	<ul style="list-style-type: none"> <li>Set a new current value for changing the current value.</li> </ul> Fetch cycle: <u>At synchronous encoder axis control start</u>	<ul style="list-style-type: none"> <li>Set in decimal.</li> <li>-2147483648 to 2147483647</li> <li>[Synchronous encoder axis position units <sup>(Note-3)</sup>]</li> </ul>	0	35042+10j 35043+10j
[Cd.323] Synchronous encoder axis error reset	<ul style="list-style-type: none"> <li>If set to "1" for resetting error and warning for the synchronous encoder axis, the error number and warning number are set to 0, and the error detection and warning detection bits status are turned OFF.</li> <li>The Simple Motion module resets the value to "0" automatically after completion of the error reset.</li> <li>In the case of the synchronous encoder axis parameter error, even if the error is reset, the setting valid flag of the synchronous encoder axis status has been OFF.</li> </ul> Fetch cycle: <u>Main cycle</u> <sup>(Note-1)</sup>	<ul style="list-style-type: none"> <li>Set in decimal.</li> <li>1: Error reset request</li> </ul>	0	35044+10j
[Cd.324] Connection command of synchronous encoder via CPU	<ul style="list-style-type: none"> <li>If set to "1", the synchronous encoder via CPU is connected.</li> <li>If set to "0", the synchronous encoder via CPU is disconnected.</li> </ul> Fetch cycle: <u>Main cycle</u> <sup>(Note-1)</sup>	<ul style="list-style-type: none"> <li>Set in decimal.</li> <li>1: Connect synchronous encoder via CPU</li> <li>0: Disconnect synchronous encoder via CPU</li> </ul>	0	35045+10j
[Cd.325] Input value for synchronous encoder via CPU	<ul style="list-style-type: none"> <li>Set a value to be used every time as the input value for the synchronous encoder for the synchronous encoder via CPU.</li> </ul> Fetch cycle: <u>Operation cycle</u>	<ul style="list-style-type: none"> <li>Set in decimal.</li> <li>-2147483648 to 2147483647 [PLS]</li> </ul>	0	35046+10j 35047+10j

j: Synchronous encoder axis No.-1

(Note-1): With the exception of positioning control, main cycle processing is executed during the next available time. It changes by status of axis start.

(Note-2): The range from axis 1 to 2 is valid in the 2-axis module, from axis 1 to 4 is valid in the 4-axis module, from axis 1 to 8 is valid in the 8-axis module, and from axis 1 to 16 is valid in the 16-axis module.

(Note-3): Synchronous encoder axis position units (Refer to Section 2.3.1)



[Cd.320] Synchronous encoder axis control start

If set to "1", the synchronous encoder axis control is started.

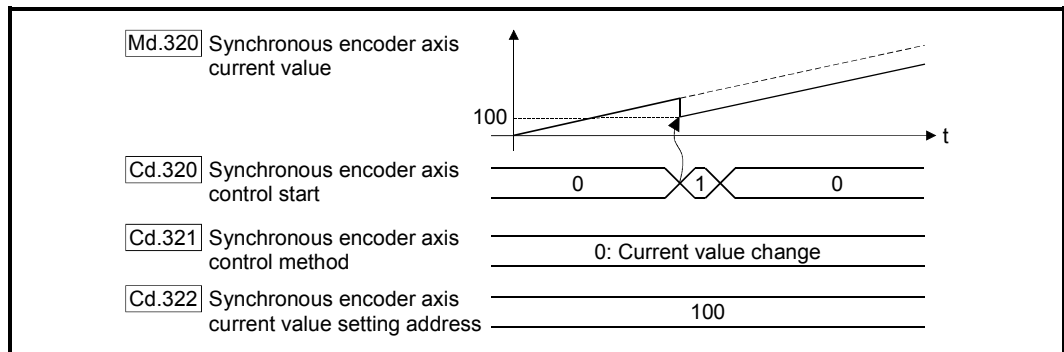

If set to "101 to 116", the synchronous encoder axis control starts based on the high-speed input request [DI] for the specified servo amplifier axis.

Set "4: High speed input request" in "[Pr.42] External command function selection" and set "1: Validates an external command" in "[Cd.8] External command valid" for the specified servo amplifier axis to start from a high speed input request [DI]. Also, set the external command signal to be used in "[Pr.95] External command signal selection" for the 16-axis module.

Set the control method for the synchronous encoder axis in "[Cd.321] Synchronous encoder axis control method".

The Simple Motion module resets the value to "0" automatically after completion of the synchronous encoder axis control.

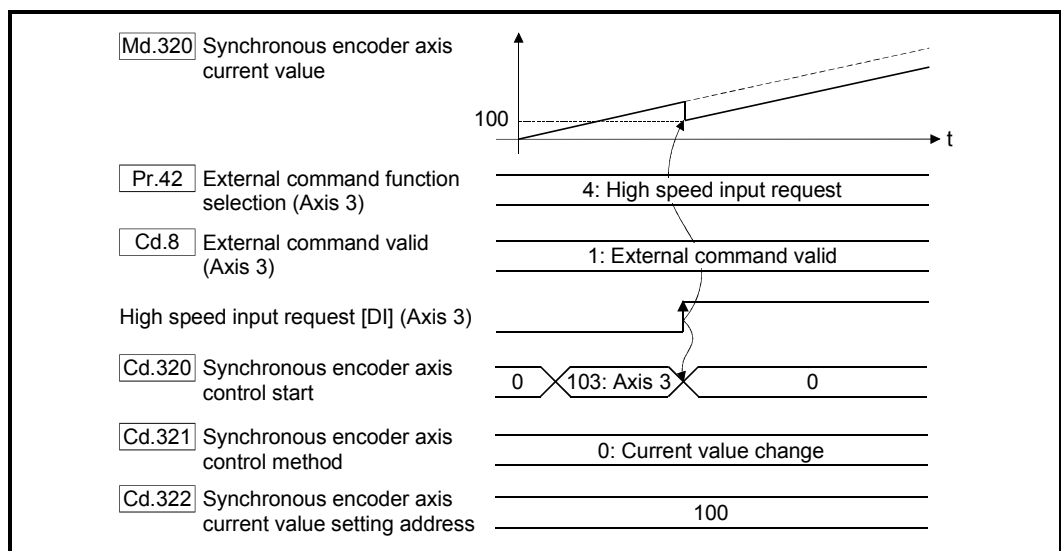

[Cd.321] Synchronous encoder axis control method

Set the control method for the synchronous encoder axis.

0: Current value change ..... The synchronous encoder axis current value and the synchronous encoder axis current value per cycle are changed as follows. Set the new current value in "[Cd.322] Synchronous encoder axis current value setting address".

Item	Change value
[Md.320] Synchronous encoder axis current value	"[Cd.322] Synchronous encoder axis current value setting address"
[Md.321] Synchronous encoder axis current value per cycle	A value that is converted "[Cd.322] Synchronous encoder axis current value setting address" into the range from 0 to "[Pr.324] Synchronous encoder axis length per cycle-1".

1: Counter disable ..... Input from the synchronous encoder is invalid. Smoothing processing, phase compensation processing and rotation direction restriction processing are continued. While these processes are valid, the input axis speed may not stop immediately when the counter disable is selected.

2: Counter enable ..... Input from the synchronous encoder is valid.

[Cd.322] Synchronous encoder axis current value setting address

Set a new current value in synchronous encoder axis position units to apply to the current value change for the synchronous encoder axis (Refer to section 2.3.1).

[Cd.323] Synchronous encoder axis error reset

If set to "1", "[Md.326] Synchronous encoder axis error No." and "[Md.327] Synchronous encoder axis warning No." are set to 0 and then "b4: Error detection flag" and "b5: Warning detection flag" of "[Md.325] Synchronous encoder axis status" are turned OFF. A synchronous encoder connection becomes valid if there is no error.

The Simple Motion module resets the value to "0" automatically after completion of the error reset.

However, the setting of the synchronous encoder axis will not be valid even if the error is reset for the setting error of the synchronous encoder axis parameter. Reconfigure the parameter and turn the power supply ON again.

[Cd.324] Connection command of synchronous encoder via CPU

Use this data when "201: Synchronous encoder via CPU" is set in "[Pr.320] Synchronous encoder axis type".

If set to "1", the synchronous encoder axis is connected. Once connected, the synchronous encoder current value is restored based on the "[Cd.325] Input value for synchronous encoder via CPU".

If set to "0", the synchronous encoder axis is disconnected.

[Cd.325] Input value for synchronous encoder via CPU

Use this data when "201: Synchronous encoder via CPU" is set in "[Pr.320] Synchronous encoder axis type".

Set a value to be used every time as the input value for the synchronous encoder in encoder pulse units.

If 1 or more is set in "[Pr.329] Resolution of synchronous encoder via CPU", it is processed as a cycle counter within the range from 0 to (resolution of synchronous encoder via CPU - 1).

### 2.3.5 Synchronous encoder axis monitor data

Monitor item	Storage details	Monitor value	Buffer memory address																																						
[Md.320] Synchronous encoder axis current value	<ul style="list-style-type: none"> <li>The current value for the synchronous encoder axis is stored.</li> </ul> <u>Refresh cycle: Operation cycle</u>	<ul style="list-style-type: none"> <li>Monitoring is carried out in decimal.</li> <li>-2147483648 to 2147483647</li> <li>[Synchronous encoder axis position units <sup>(Note-1)</sup>]</li> </ul>	35200+20j 35201+20j																																						
[Md.321] Synchronous encoder axis current value per cycle	<ul style="list-style-type: none"> <li>The current value per cycle for a synchronous encoder axis is stored.</li> </ul> <u>Refresh cycle: Operation cycle</u>	<ul style="list-style-type: none"> <li>Monitoring is carried out in decimal.</li> <li>0 to (Synchronous encoder axis length per cycle-1)</li> <li>[Synchronous encoder axis position units <sup>(Note-1)</sup>]</li> </ul>	35202+20j 35203+20j																																						
[Md.322] Synchronous encoder axis speed	<ul style="list-style-type: none"> <li>The speed for a synchronous encoder axis is stored.</li> </ul> <u>Refresh cycle: Operation cycle</u>	<ul style="list-style-type: none"> <li>Monitoring is carried out in decimal.</li> <li>-2147483648 to 2147483647</li> <li>[Synchronous encoder axis speed units <sup>(Note-2)</sup>]</li> </ul>	35204+20j 35205+20j																																						
[Md.323] Synchronous encoder axis phase compensation amount	<ul style="list-style-type: none"> <li>The phase compensation amount is stored.</li> </ul> <u>Refresh cycle: Operation cycle</u>	<ul style="list-style-type: none"> <li>Monitoring is carried out in decimal.</li> <li>-2147483648 to 2147483647</li> <li>[Synchronous encoder axis position units <sup>(Note-1)</sup>]</li> </ul>	35206+20j 35207+20j																																						
[Md.324] Synchronous encoder axis rotation direction restriction amount	<ul style="list-style-type: none"> <li>While the rotation direction is restricted, the accumulation for the input travel value in the opposite direction of the enabled direction is stored.</li> </ul> <u>Refresh cycle: Operation cycle</u>	<ul style="list-style-type: none"> <li>Monitoring is carried out in decimal.</li> <li>-2147483648 to 2147483647</li> <li>[Synchronous encoder axis position units <sup>(Note-1)</sup>]</li> </ul>	35208+20j 35209+20j																																						
[Md.325] Synchronous encoder axis status	<ul style="list-style-type: none"> <li>The status for a synchronous encoder axis is monitored.</li> </ul> <u>Refresh cycle: Operation cycle</u>	<ul style="list-style-type: none"> <li>Monitoring is carried out in hexadecimal.</li> </ul> <p>Buffer memory</p> <table border="1"> <tr> <td>b15</td><td>b12</td><td>b8</td><td>b4</td><td>b0</td> </tr> <tr> <td> </td><td> </td><td> </td><td> </td><td> </td> </tr> <tr> <td colspan="5" style="text-align: center;">Not used</td> </tr> <tr> <th colspan="2">Stored items</th> <th colspan="3">Meaning</th> </tr> <tr> <td>b0</td><td>Setting valid flag</td> <td colspan="3" rowspan="5" style="text-align: center; vertical-align: middle;">0: OFF 1: ON</td> </tr> <tr> <td>b1</td><td>Connecting valid flag</td> </tr> <tr> <td>b2</td><td>Counter enable flag</td> </tr> <tr> <td>b3</td><td>Current value setting request flag</td> </tr> <tr> <td>b4</td><td>Error detection flag</td> </tr> <tr> <td>b5</td><td>Warning detection flag</td> <td colspan="3"> </td> </tr> </table>	b15	b12	b8	b4	b0						Not used					Stored items		Meaning			b0	Setting valid flag	0: OFF 1: ON			b1	Connecting valid flag	b2	Counter enable flag	b3	Current value setting request flag	b4	Error detection flag	b5	Warning detection flag				35210+20j
b15	b12	b8	b4	b0																																					
Not used																																									
Stored items		Meaning																																							
b0	Setting valid flag	0: OFF 1: ON																																							
b1	Connecting valid flag																																								
b2	Counter enable flag																																								
b3	Current value setting request flag																																								
b4	Error detection flag																																								
b5	Warning detection flag																																								
[Md.326] Synchronous encoder axis error No.	<ul style="list-style-type: none"> <li>The error code for the synchronous encoder axis is stored.</li> </ul> <u>Refresh cycle: Operation cycle</u>	<ul style="list-style-type: none"> <li>Monitoring is carried out in hexadecimal.</li> <li>(Refer to Section 6.2.1 "List of input axis errors")</li> </ul>	35211+20j																																						
[Md.327] Synchronous encoder axis warning No.	<ul style="list-style-type: none"> <li>The warning code for the synchronous encoder axis is stored.</li> </ul> <u>Refresh cycle: Operation cycle</u>	<ul style="list-style-type: none"> <li>Monitoring is carried out in hexadecimal.</li> <li>(Refer to Section 6.2.2 "List of input axis warnings")</li> </ul>	35212+20j																																						

j: Synchronous encoder axis No.-1

(Note-1): Synchronous encoder axis position units (Refer to Section 2.3.1)

(Note-2): Synchronous encoder axis speed units (Refer to Section 2.3.1)

**[Md.320] Synchronous encoder axis current value**

The current value for the synchronous encoder axis is stored in synchronous encoder axis position units (Refer to Section 2.3.1).

The synchronous encoder position for an incremental synchronous encoder is "0" immediately after the power supply ON.

**[Md.321] Synchronous encoder axis current value per cycle**

The current value per cycle for a synchronous encoder axis is stored in the range from 0 to ("[Pr.324] Synchronous encoder axis length per cycle"-1).

The unit is synchronous encoder axis position units (Refer to Section 2.3.1).

**[Md.322] Synchronous encoder axis speed**

The speed for a synchronous encoder axis is stored in synchronous encoder axis speed units (Refer to Section 2.3.1).

If the speed for a synchronous encoder axis exceeds the monitor range (Refer to Section 2.3.1), the warning "Input axis speed display over" (warning code: 682) will occur. In this case, use a smaller number of decimal places for the speed in "[Pr.321] Synchronous encoder axis unit setting" or set the speed time units to "0: second [s]".

**[Md.323] Synchronous encoder axis phase compensation amount**

The phase compensation amount for a synchronous encoder axis is stored in the synchronous encoder axis position units (Refer to Section 2.3.1).

The phase compensation amount for a synchronous encoder axis is the value after smoothing processing and phase compensation processing.

**[Md.324] Synchronous encoder axis rotation direction restriction amount**

While the rotation direction is restricted for a synchronous encoder axis, the accumulation for input travel in the opposite direction of the enabled direction is stored in synchronous encoder axis position units (Refer to Section 2.3.1) as follows.

Setting value of "[Pr.328] Synchronous encoder axis rotation direction restriction"	Storage details
1: Enable only for current value increase direction	A negative accumulation is stored during rotation direction restriction. 0 is stored if there is no restriction.
2: Enable only for current value decrease direction	A positive accumulation is stored during rotation direction restriction. 0 is stored if there is no restriction.

Rotation direction restriction is processed after phase compensation processing.

Therefore, if undershoot occurs from phase compensation during deceleration stop, the rotation direction restriction amount might remain.

## [Md.325] Synchronous encoder axis status

The each status for a synchronous encoder axis is monitored with the following each bits.

Bit	Storage item	Storage details
b0	Setting valid flag	At power supply ON, this flag turns ON when the synchronous encoder axis parameter ([Pr.320] to [Pr.329]) is normal and the setting of the synchronous encoder axis is valid. It is turned OFF when the setting is invalid or an error occurs.
b1	Connecting valid flag	When the synchronous encoder axis setting is valid, the synchronous encoder connection also becomes valid and this flag turns ON. This flag turns OFF when the connection is invalid. When setting an incremental synchronous encoder, this flag turns ON simultaneously the power supply turns ON regardless of connecting the current encoder.
b2	Counter enable flag	This flag turns ON when input from the synchronous encoder is enabled. If the counter disable control <sup>(Note-1)</sup> is executed, it is turned OFF, and input from the synchronous encoder becomes invalid. If the counter enable control <sup>(Note-1)</sup> is executed, it is turned ON, and input from the synchronous encoder becomes valid. When the synchronous encoder is valid to connect, the initial status is ON (enable) status.
b3	Current value setting request flag	This flag turns ON, when a synchronous encoder axis current value change is never executed. If the current value setting request flag is ON for the synchronous encoder connection, the synchronous encoder axis current value starts counting with 0. This flag turns OFF when a synchronous encoder axis current value change is executed.
b4	Error detection flag	This flag turns ON when an error occurs for the synchronous encoder axis. The error No. is stored in "[Md.326] Synchronous encoder axis error No.". Reset the error in "[Cd.323] Synchronous encoder axis error reset".
b5	Warning detection flag	This flag turns ON when a warning occurs for the synchronous encoder axis. The warning No. is stored in "[Md.327] Synchronous encoder axis warning No.". Reset the warning in "[Cd.323] Synchronous encoder axis error reset".
b6 to b15	Not used	Always OFF

(Note-1): Set the control method for synchronous encoder in "[Cd.321] Synchronous encoder axis control method".  
(Refer to Section 2.3.4)

## [Md.326] Synchronous encoder axis error No.

When an error for a synchronous encoder axis is detected, the error code corresponding to the error details is stored.

If set to "1" in "[Cd.323] Synchronous encoder axis error reset", the value is set to "0".

## [Md.327] Synchronous encoder axis warning No.

When a warning for a synchronous encoder axis is detected, the warning code corresponding to the warning details is stored.

If set to "1" in "[Cd.323] Synchronous encoder axis error reset", the value is set to "0".

# Chapter 3 Cam Function

The details on cam data and operation for cam function in output axis (cam axis) are explained in this chapter.

The cam function controls output axis by creating cam data that corresponds to the operation.

The functions to operate cam data include "Cam data operation function", "Cam auto-generation function", and "Cam position calculation function".

Refer to Chapter 4 "Synchronous control" for setting the output axis.

Refer to Section 5.5 "Cam position calculation function".

3.1	Control details for cam function.....	3- 2
3.2	Create cam data.....	3-10
3.2.1	Memory configuration of cam data.....	3-10
3.2.2	Cam data operation function.....	3-13
3.2.3	Cam auto-generation function.....	3-17

### 3.1 Control details for cam function

The output axis for synchronous control is operated with a cam.  
 The following operations can be performed with cam functions.

- Two-way operation: Reciprocating operation with a constant cam strokes range.
- Feed operation : Cam reference position is updated every cycle.
- Linear operation : Linear operation (cam No.0) in the cycle as the stroke ratio is 100%.

The output axis is controlled by a value (feed current value), which is converted from the input value (cam axis current value per cycle) by cam data.

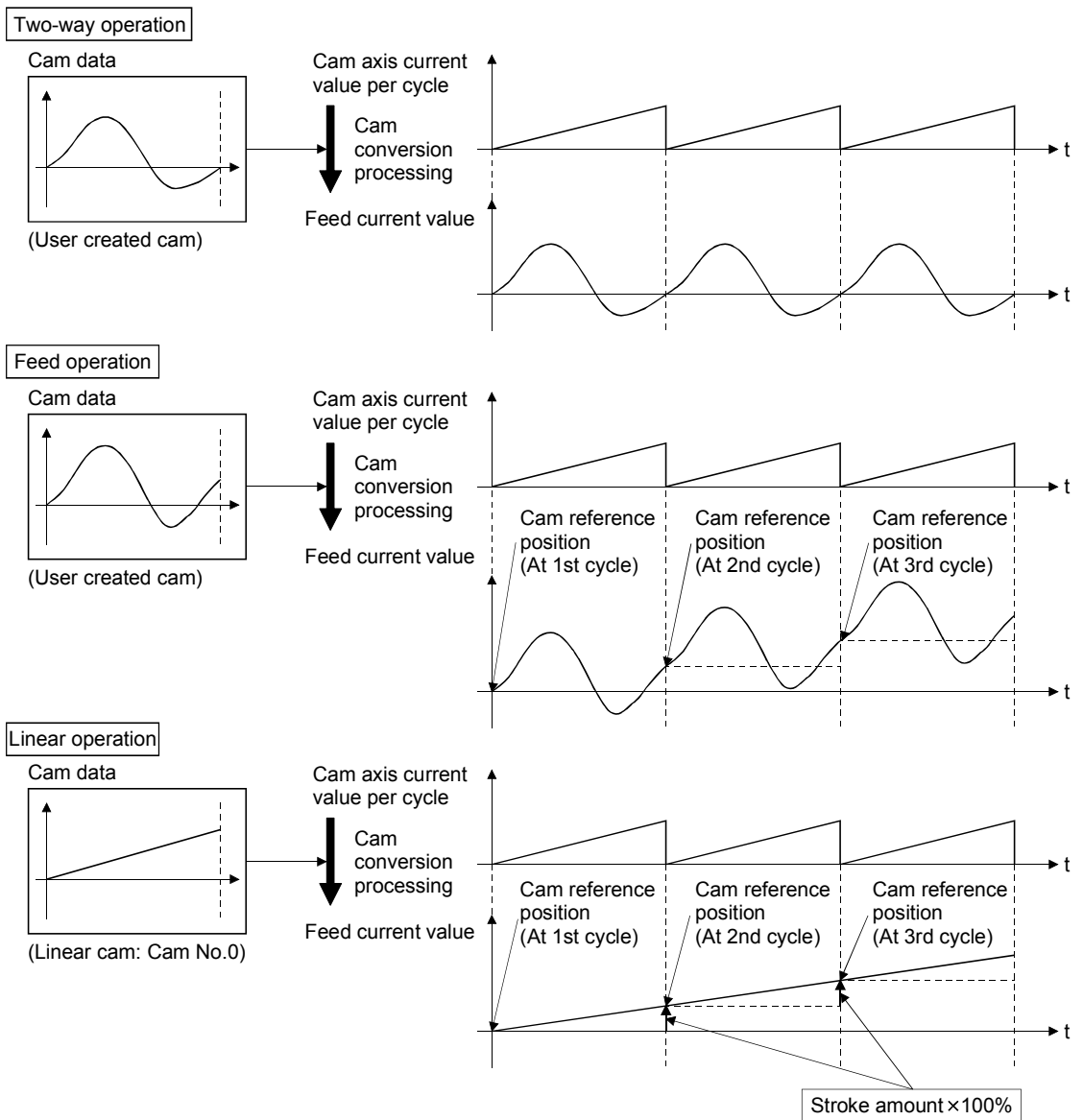



■ Cam data

The cam data used in the cam function includes "storage data" which is used for reading/writing with GX Works2 and "open data" which is transmitted to the internal memory at cam control.

Storage data		Open data
— (Reading and writing not possible)		Linear cam
Stroke ratio data format		Stroke ratio data format
Auto-generation data format	cam for rotary cutter	
Coordinate data format		Coordinate data format

Storage data and open data are same for cams using the stroke ratio data format and the coordinate data format. A cam using the auto-generation data format (storage data) operates after being changed (transmitted) to the stroke ratio data format.

[Data read/written with GX Works2]

To re-edit the cam data read from the Simple Motion module with GX Works2, read/write both of "cam data (edit data)" and "cam data (converted data)" when reading/writing the cam data. If only "cam data (conversion data)" is read/written, re-edition may not be executed or the information such as units and strokes may be missed.

The explanation of each cam data is shown below.

(1) Linear cam control

When "0" is set for "[Pr.440] Cam No.", the cam data operates as a straight line with a 100% stroke ratio at the last point.

The linear cam does not consume the cam open area. Also, it cannot be read/written as storage data.

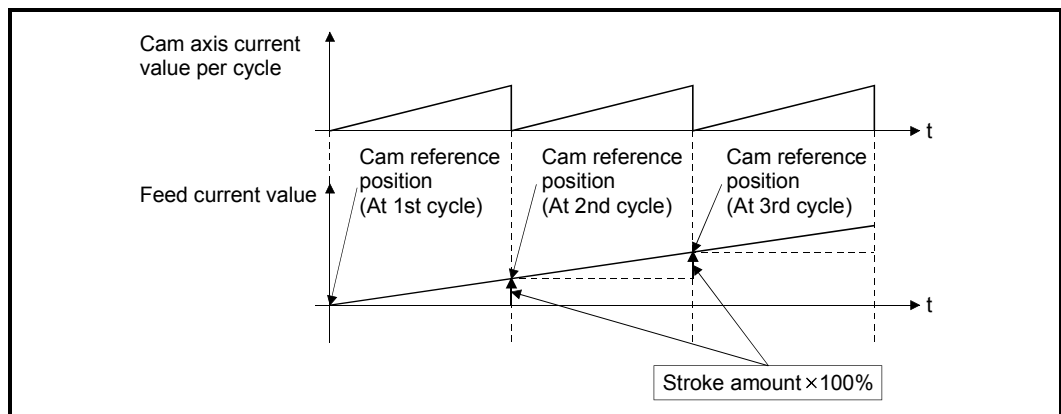

(2) Stroke ratio data format

The stroke ratio data format is defined in equal divisions for one cam cycle based on the cam resolution, and configured with stroke ratio data from points within the cam resolution.

Refer to Section 3.2 "Create cam data" for setting methods for cam data.

Setting item	Setting details	Setting range	Default value (GX Works2)	Cam data operation function
Cam No.	Set the cam No.	0 : Linear cam 1 to 256: User created cam	1	[Cd.601] Operation cam No.
Cam data format	Set "1". (Setting with GX Works2 is not required.)	1: Stroke ratio data format	1	[Cd.604] Cam data format
Cam resolution	Set the number of divisions for one cam cycle.	256/512/1024/2048/4096/8192/ 16384/32768	256	[Cd.605] Cam resolution/ coordinate number
Cam data starting point	Set the cam data point corresponding to "Cam axis current value per cycle = 0".	0 to (Cam resolution - 1)	0	[Cd.606] Cam data starting point
Stroke ratio data	Set the stroke ratio from the 1st to the last point. (The 0th point setting is not required. It is always 0%.)	-2147483648 to 2147483647 [ $\times 10^{-7}\%$ ] (Note-1) (-214.7483648 to 214.7483647%)	0	[Cd.607] Cam data value

(Note-1): For setting the stroke ratio out of range  $\pm 100\%$  with GX Works2 (Simple Motion Module Setting Tool), check the "Display advanced cam graph stroke" by selecting the [Cam Data] of [Project] on the options screen displayed by the menu bar [Tools] - [Options].

Example) Cam resolution: 512

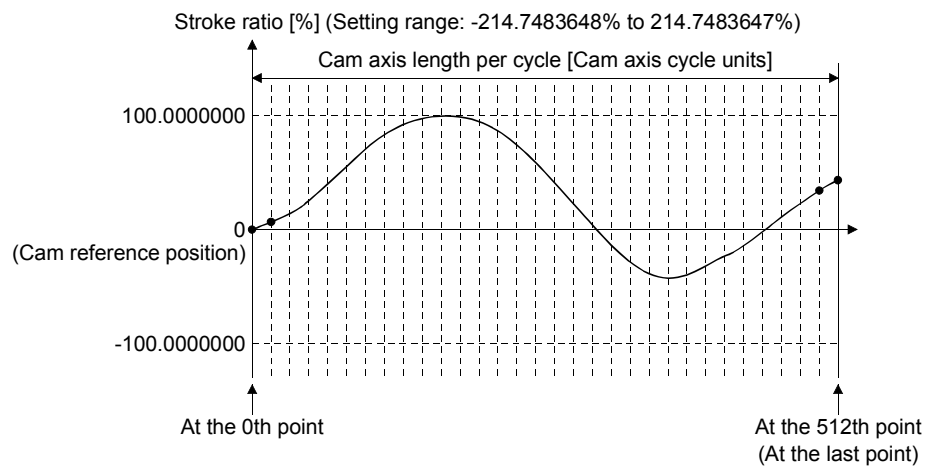

(3) Coordinate data format

The coordinate data format is defined in coordinates of more than 2 points for one cam cycle. The coordinate data is represented as "(Input value, Output value)".

- Input value : Cam axis current value per cycle
- Output value : Stroke position from cam reference position

With this format, "[Pr.441] Cam stroke amount" of output axis parameter is ignored and output value of the coordinate data becomes cam stroke position.

Refer to Section 3.2 "Create cam data" for setting methods of cam data.

Setting item	Setting details	Setting range	Default value (GX Works2)	Cam data operation function
Cam No.	Set the cam No.	0 : Linear cam 1 to 256: User created cam	1	[Cd.601] Operation cam No.
Cam data format	Set "2". (Setting with GX Works2 is not required.)	2: Coordinate data format	2	[Cd.604] Cam data format
Coordinate number	Set the number of coordinate points in one cam cycle. The coordinates are included at the 0th point.	2 to 16384	2	[Cd.605] Cam resolution/ coordinate number
Cam data starting point	Setting is not required with coordinate data format.	—	—	[Cd.606] Cam data starting point
Coordinate data	Set all coordinate data (input value: $X_n$ , output value: $Y_n$ ). Required to set the coordinate data ( $X_0, Y_0$ ) from the 0th point. The input value should be larger than the previous coordinate data ( $X_n < X_{n+1}$ ).	Input value: 0 to 2147483647 [Cam axis cycle units] Output value: -2147483648 to 2147483647 [Output axis position units]	0	[Cd.607] Cam data value

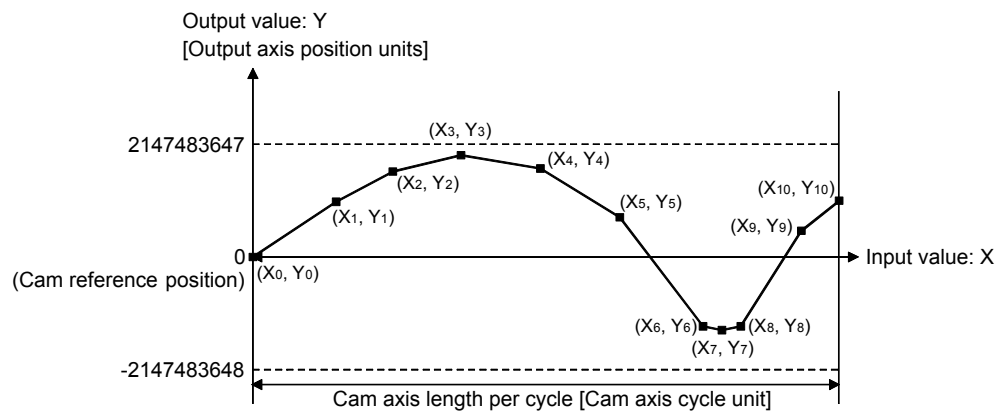

When an input value that is 0 or the cam axis length per cycle does not exist in the coordinate data, the coordinate is calculated from the line segment between the nearest two coordinates.

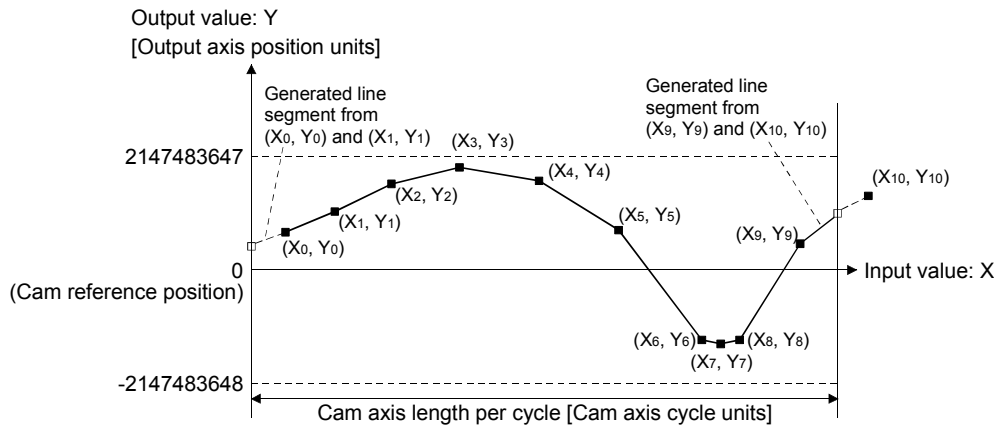

(4) Auto-generation data format

A cam pattern is created based on the specified parameter (data for auto-generation). Control cam data is created in the stroke ratio data format in the cam open area. Therefore, the operation specification during the control conforms to the cam using the stroke ratio data format.

The types of cam patterns for auto-generation data format are as follows.

Auto-generation type	Features
Cam for rotary cutter	The cam pattern for a rotary cutter can be created easily.

**⚠ CAUTION**

- If the cam data is set incorrectly, similarly to the incorrectly setting of a target value and command speed in the positioning control, the position and speed command to the servo amplifier increases, and may cause machine interface and servo alarms such as "Overspeed" and "Command frequency error". When creating and changing cam data, execute a trial operation and provide the appropriate adjustments. Refer to "Safety precautions" for precautions on trial operations and adjustments.

■ Feed current value of cam axis

The feed current value is calculated as shown below.

(1) Stroke ratio data format

$$\text{Feed current value} = \text{Cam reference position} + \text{Cam stroke amount} \times \text{Stroke ratio corresponding to cam axis current value per cycle}$$

(2) Coordinate data format

$$\text{Feed current value} = \text{Cam reference position} + \text{Output value corresponding to cam axis current value per cycle}$$

When the cam axis current value per cycle is in the middle of the defined cam data (Stroke ratio data/Coordinate data), the middle value is calculated from the nearest cam data.

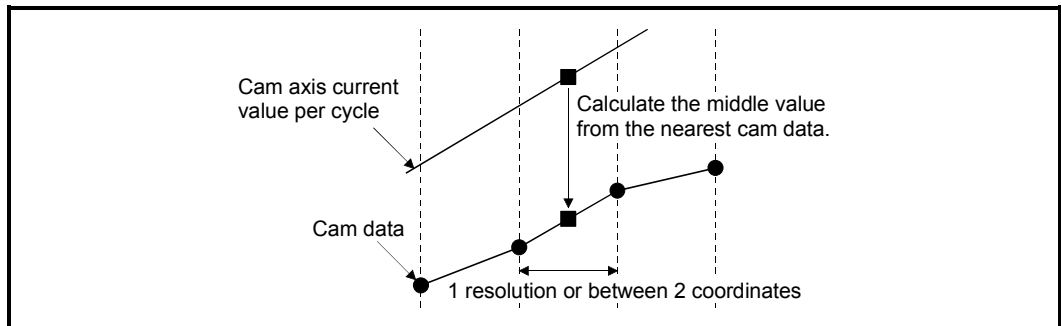

■ Cam reference position

The cam reference position is calculated as shown below.

(1) Stroke ratio data format

$$\text{Cam reference position} = \text{The preceding cam reference position} + \text{Cam stroke amount} \times \text{Stroke ratio at the last point}$$

(2) Coordinate data format

$$\text{Cam reference position} = \text{The preceding cam reference position} + \text{Output value corresponding to "Input value = Cam axis length per cycle"} - \text{Output value corresponding to "Input value = 0"}$$

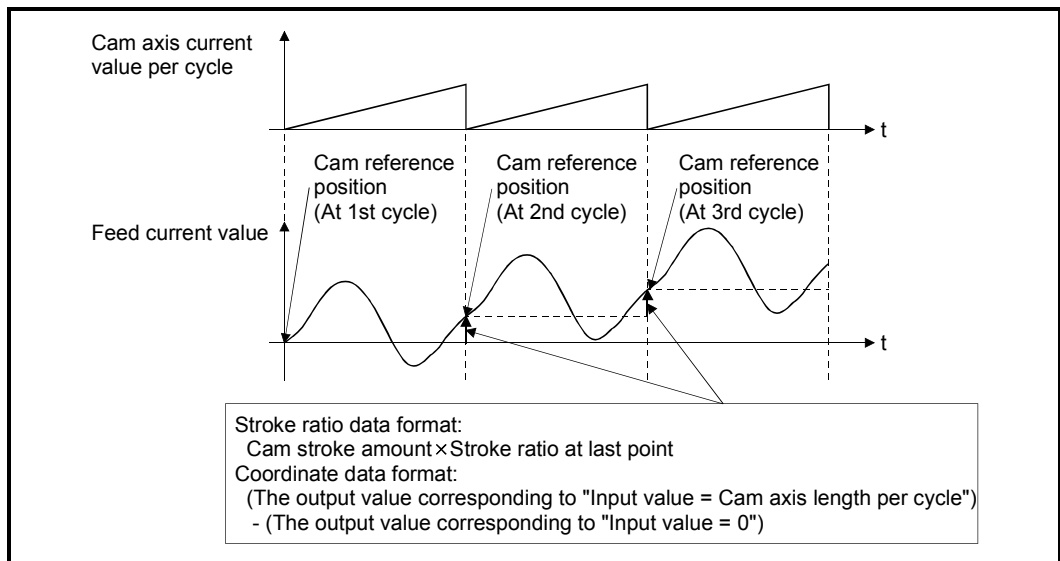

Create cam data for two-way cam operation as shown below.

(1) Stroke ratio data format

Create cam data so that the stroke ratio is 0% at the last point.

(2) Coordinate data format

Create cam data with the same output value for the point where the input value is 0 and the input value is equal to the cam axis length per cycle.

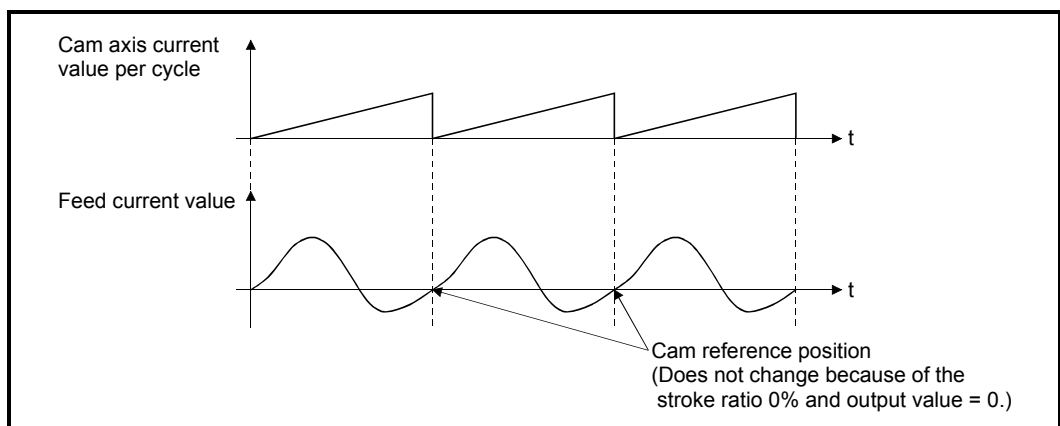

### ■ Cam data starting point

This setting is only valid for cam data using the stroke ratio data format.

The cam data point corresponding to "Cam axis current value per cycle = 0" can be set as the cam data starting point.

The default value of the cam data starting point is 0. (The cam axis is controlled with cam data starting from the 0th point (stroke ratio 0%).)

When a value other than 0 is set for the cam data starting point, cam control is started from the point where the stroke ratio is not 0%.

The cam data starting point is set for each cam data. The setting range is from 0 to (cam resolution - 1).

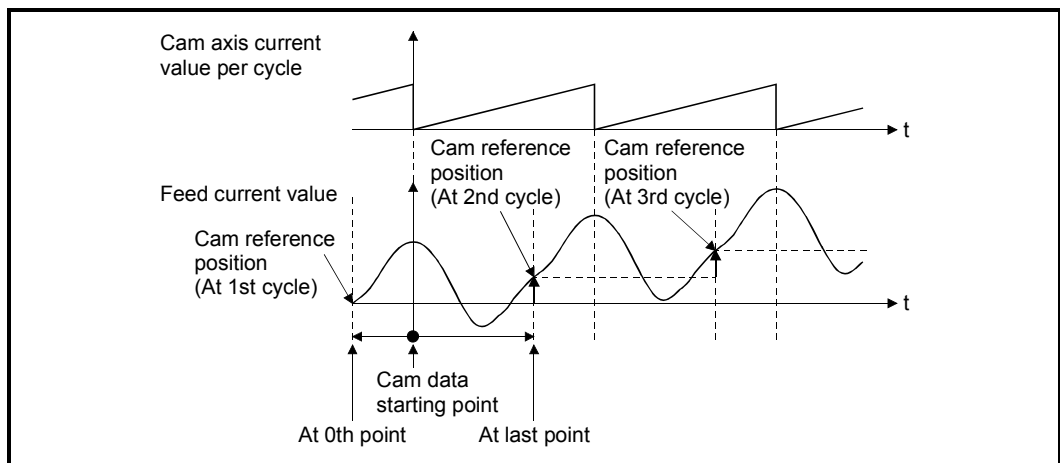

### ■ Timing of applying cam control data

#### (1) Stroke ratio data format

If "[Pr.440] Cam No." or "[Pr.441] Cam stroke amount" is changed during synchronous control, the new value is accepted and applied when the cam axis current value per cycle passes through the 0th point of cam data, or is on the 0th point.

The cam reference position is updated when the cam axis current value per cycle passes through the 0th point of cam data.

#### (2) Coordinate data format

If "[Pr.440] Cam No." is changed during synchronous control, the new value is accepted and applied when the cam axis current value per cycle passes through 0, or is on 0.

The cam reference position is updated when the cam axis current value per cycle passes through 0.

## 3.2 Create cam data

### 3.2.1 Memory configuration of cam data

Cam data is arranged in the following 2 areas.

Memory configuration	Storage item	Details	Remark
Cam storage area	Cam data	Data is written by the following operations. <ul style="list-style-type: none"> <li>• Write with GX Works2</li> <li>• When executing "write (Cam storage area)" with the cam data operation function</li> </ul>	<ul style="list-style-type: none"> <li>• Data is preserved even when turning the power supply OFF.</li> </ul>
	Cam auto-generation data	Data is written when the cam auto-generation request is executed. (Cam auto-generation function)	
Cam open area	Cam data	Cam data is transmitted from the cam storage area by the following operations. <ul style="list-style-type: none"> <li>• Power supply turn ON</li> <li>• Write to the cam storage area</li> <li>• PLC READY signal [Y0] OFF to ON</li> <li>• When specifying the cam open area with the cam data operation function</li> <li>• When executing the cam auto-generation function</li> </ul>	<ul style="list-style-type: none"> <li>• Data is lost when turning the power supply OFF.</li> <li>• The cam data that is used in cam control is stored.</li> </ul>

Previously written cam data can be used after turning the power supply OFF by writing data in the cam storage area. Cam data should be written in the cam storage area for normal use. It is possible to write directly to the cam open area via buffer memory when registering cam data that exceeds the memory capacity in the cam storage area, etc. (Refer to Section 3.2.2 "Cam data operation function".) Writing must be executed to the cam open area due to clearing the data at the power supply OFF.



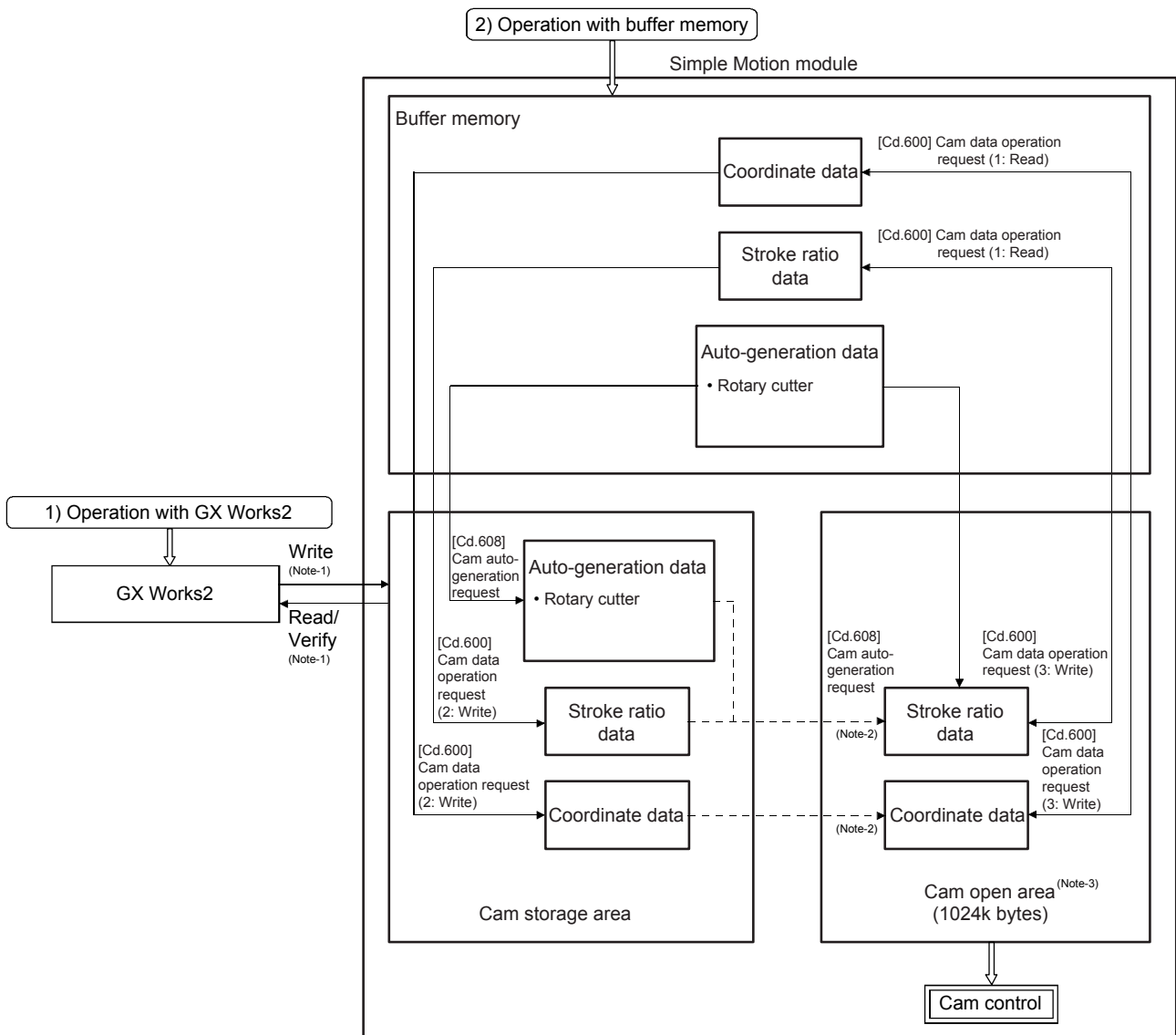

### ■ Cam data operation with GX Works2

Cam data can be modified while viewing the waveform with GX Works2.

The cam data is written/read/verified to the cam storage area with GX Works2, however it cannot be executed to the cam open area.

The waveform generated by the cam auto-generation function can be confirmed by the "Cam graph" of the "Cam Data window" from the navigation window of the "Cam Data" through reading with GX Works2.

### ■ Cam data operation with buffer memory

It is possible to specify the area where cam data is written. The cam data is read from the cam open area. (Refer to Section 3.2.2 "Cam data operation function")

With the cam auto-generation function, auto-generation data is saved in the cam storage area, and the cam data is generated into the cam open area.

### ■ Cam data capacity

The size of the created cam data is shown below for the cam storage area/cam open area.

Operation method	Data method/ Auto-generation type	Cam storage area (262144 bytes)	Cam open area (1048576 bytes)
Create with GX Works2	Stroke ratio data format	Cam resolution × 4 bytes	Cam resolution × 4 bytes
	Coordinate data format	Coordinate number × 8 bytes	Coordinate number × 8 bytes
Create in cam storage area with cam data operation function	Stroke ratio data format	Cam resolution × 4 bytes	Cam resolution × 4 bytes
	Coordinate data format	Coordinate number × 8 bytes	Coordinate number × 8 bytes
Create in cam open area with cam data operation function	Stroke ratio data format	0 byte	Cam resolution × 4 bytes
	Coordinate data format		Coordinate number × 8 bytes
Create with cam auto-generation	For a rotary cutter	28 bytes	Cam resolution × 4 bytes

When writing with the cam data operation function or when the cam auto-generation function is executed, the writing area free capacity size may decrease since the size changes depending on the cam resolution change, etc. In this case, write the cam data with GX Works2 or delete them once.

### ■ Delete method of cam data

The data of cam storage area/cam open area can be deleted (initialize) by the parameter initialization function with a parameter setting and positioning data. The parameter initialization function is executed by setting "1" in "[Cd.2] Parameter initialization request". Write the empty data in the cam storage area with GX Works2 to delete only cam data.

### ■ Password protection for cam data

The cam data can be protected as shown below by password setting.

Password setting	Cam data operation with GX Works2	Cam data operation with buffer memory
Password for read protection	Cam data cannot be read without unlocking the password for read protection.	Reading cam data is not operated.
Password for write protection	Cam data cannot be written without unlocking the password for write protection.	Writing cam data and generating cam data auto-generation is not operated.

The password for cam data is deleted with cam data by "[Cd.2] Parameter initialization request".

## 3.2.2 Cam data operation function

This function is used to write/read cam data via buffer memory with the cam operation control data. The amount of data for each operation is 4096 points with the stroke ratio data format, and 2048 points with the coordinate data format. If it is more than that, the operation should be executed separately.

■ Cam operation control data

Setting item	Setting details	Setting value (Read operation: Stored value)	Default value	Buffer memory address
[Cd.600] Cam data operation request	<ul style="list-style-type: none"> <li>Set the command for operating cam data.</li> <li>The Simple Motion module resets the value to "0" automatically after completion of cam data operation.</li> </ul> Fetch cycle: <u>Main cycle</u> (Note-1)	<ul style="list-style-type: none"> <li>Set in decimal.</li> <li>1: Read (Cam open area)</li> <li>2: Write (Cam storage area)</li> <li>3: Write (Cam open area)</li> </ul>	0	45000
[Cd.601] Operation cam No.	<ul style="list-style-type: none"> <li>Set the operating cam No.</li> </ul> Fetch cycle: <u>At requesting cam data operation</u>	<ul style="list-style-type: none"> <li>Set in decimal.</li> <li>1 to 256</li> </ul>	0	45001
[Cd.602] Cam data first position	<ul style="list-style-type: none"> <li>Set the first position for the operating cam data.</li> </ul> Fetch cycle: <u>At requesting cam data operation</u>	<ul style="list-style-type: none"> <li>Set in decimal.</li> <li>Stroke ratio data format 1 to cam resolution</li> <li>Coordinate data format 0 to (Coordinate number - 1)</li> </ul>	0	45002
[Cd.603] Number of cam data operation points	<ul style="list-style-type: none"> <li>Set the number of operating cam data points.</li> </ul> Fetch cycle: <u>At requesting cam data operation</u>	<ul style="list-style-type: none"> <li>Set in decimal.</li> <li>Stroke ratio data format 1 to 4096</li> <li>Coordinate data format 1 to 2048</li> </ul>	0	45003
[Cd.604] Cam data format	<ul style="list-style-type: none"> <li>Write operation: Set cam data format.</li> </ul> Fetch cycle: <u>At requesting cam data operation</u> <ul style="list-style-type: none"> <li>Read operation: The cam data format is stored.</li> </ul> Refresh cycle: <u>At completing cam data operation</u>	<ul style="list-style-type: none"> <li>Set in decimal.</li> <li>1: Stroke ratio data format</li> <li>2: Coordinate data format</li> </ul>	0	45004
[Cd.605] Cam resolution/coordinate number	<ul style="list-style-type: none"> <li>Write operation: Set the cam resolution/the coordinate number.</li> </ul> Fetch cycle: <u>At requesting cam data operation</u> <ul style="list-style-type: none"> <li>Read operation: The cam resolution/the coordinate number is stored.</li> </ul> Refresh cycle: <u>At completing cam data operation</u>	<ul style="list-style-type: none"> <li>Set in decimal.</li> <li>Stroke ratio data format 256/512/1024/2048/4096/8192/16384/32768</li> <li>Coordinate data format 2 to 16384</li> </ul>	0	45005

(Note-1): With the exception of positioning control, main cycle processing is executed during the next available time. It changes by status of axis start.

Setting item	Setting details	Setting value (Read operation: Stored value)	Default value	Buffer memory address
[Cd.606] Cam data starting point	<ul style="list-style-type: none"> <li>Write operation: Set the cam data starting point. <u>Fetch cycle: At requesting cam data operation</u></li> <li>Read operation: The cam data starting point is stored. <u>Refresh cycle: At completing cam data operation</u></li> <li>Setting is not required with coordinate data format.</li> </ul>	<ul style="list-style-type: none"> <li>Set in decimal.</li> <li>Stroke ratio data format 0 to (Cam resolution - 1)</li> <li>Coordinate data format Setting not required</li> </ul>	0	45006
[Cd.607] Cam data value	<ul style="list-style-type: none"> <li>Write operation: Set the cam data corresponding to the cam data format. <u>Fetch cycle: At requesting cam data operation</u></li> <li>Read operation: The cam data is stored. <u>Refresh cycle: At completing cam data operation</u></li> </ul>	<ul style="list-style-type: none"> <li>Set in decimal.</li> <li>Stroke ratio data format -2147483648 to 2147483647[<math>\times 10^{-7}\%</math>]</li> <li>Coordinate data format Input value: 0 to 2147483647 [Cam axis cycle units (Note-2)] Output value: -2147483648 to 2147483647 [Output axis position units (Note-3)]</li> </ul>	0	45008 to 53199

(Note-2): Cam axis cycle units (Refer to Section 4.5.1)

(Note-3): Output axis position units (Refer to Section 4.5.1)

### [Cd.600] Cam data operation request

Set the following commands to write/read cam data.

- 1: Read (Cam open area) ..... The cam is read from the cam open area and stored to the buffer memory.
- 2: Write (Cam storage area)..... The cam data is written to the cam storage area and the cam open area from the buffer memory.
- 3: Write (Cam open area)..... The cam data is written to the cam open area from the buffer memory.

The setting value is reset to "0" automatically after completion of cam data operation.

If a warning occurs when requesting cam data operation, the warning number is stored in "[Md.24] Axis warning No." of axis 1, and the setting value is reset to "0" automatically.

When another request command is set, the operation does not get executed and the setting value is reset to "0" automatically.

### [Cd.601] Operation cam No.

Set the cam No. to write/read.

### [Cd.602] Cam data first position

Set the first position of the cam data to write/read.

Set the cam data first position within the range from 1 to the cam resolution in cam resolution units using the stroke ratio data format. The stroke ratio of the 0th cam data is 0% fixed, and this data cannot be written/read.

Set a value within the range from 0 to (Coordinate number - 1) with the coordinate data format.

[Cd.603] Number of cam data operation points

Set the number of operation points to write/read starting from the first position of cam data. The following shows the operation details when the value of "Cam data first position + Cam data operation points - 1" is larger than the cam resolution in the stroke ratio data format.

Reading: The cam data from the first position to the cam resolution is read in the buffer memory.

Writing : The warning "Outside number of cam data operation points range" (warning code 813) occurs, and writing is not executed.

The following shows the operation details when the value of "Cam data first position + Cam data operation points" is larger than the coordinate number with the coordinate data format.

Reading: The cam data from the first position to the last coordinate is read in the buffer memory.

Writing : The warning "Outside number of cam data operation points range" (warning code 813) occurs, and writing is not executed.

[Cd.604] Cam data format

Set one of the following cam data formats.

- 1: Stroke ratio data format
- 2: Coordinate data format

[Cd.605] Cam resolution/coordinate number

Set/load the cam resolution/the coordinate number.

Reading: The cam resolution/the coordinate number of the set cam data is read.

Writing : Set the cam resolution with the following values when using the stroke ratio data format.

256/512/1024/2048/4096/8192/16384/32768

Set the coordinate number within the range from 2 to 16384 when using the coordinate data format.

[Cd.606] Cam data starting point

Set/load the cam data starting point. This is used with the stroke ratio data format.

Reading: The cam starting point of the set cam data is read.

Writing : Set the cam data starting point within the range from 0 to (Cam resolution - 1).

[Cd.607] Cam data value

Set/load the cam data operation points according to one of the following formats.

(1) Stroke ratio data format

Buffer memory address	Item	Setting value
45008 45009	Stroke ratio at first point	-2147483648 to 2147483647 [ $\times 10^{-7}\%$ ] (-214.7483648 to 214.7483647 [%])
45010 45011	Stroke ratio at second point	
to	to	
53198 53199	Stroke ratio at 4096th point.	

(2) Coordinate data format

Buffer memory address	Item		Setting value
45008 45009	At first point	Input value	0 to 2147483647 [Cam axis cycle unit]
45010 45011		Output value	-2147483648 to 2147483647 [Output axis position unit]
45012 45013	At second point	Input value	0 to 2147483647 [Cam axis cycle unit]
45014 45015		Output value	-2147483648 to 2147483647 [Output axis position unit]
to	to		to
53196 53197	At 2048th point	Input value	0 to 2147483647 [Cam axis cycle unit]
53198 53199		Output value	-2147483648 to 2147483647 [Output axis position unit]

[Cd.601] to [Cd.607] Cam data

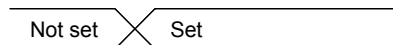

[Cd.600] Cam data operation request

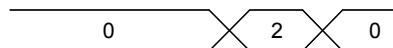

### 3.2.3 Cam auto-generation function

The cam auto-generation function is used to generate cam data automatically for specific purposes based on parameter settings.

With this function, cam data is generated in the cam open area.

It is possible to generate up to 1 Mbyte including the regular cam data. (Example: 256 cam data (with the stroke ratio format, resolution is 1024) can be automatically generated.)

The processing time of cam auto-generation takes longer if the data point is larger. Also, the real processing time changes by status of axis start etc.

(Reference) Relationship between the cam resolution and processing time in the cam auto-generation (Stroke ratio data format)

Cam resolution	256	4096	32768
Processing time (μs)	257.75	4519.75	33012.0

#### ■ Cam operation control data

Setting item	Setting details	Setting value	Default value	Buffer memory address
[Cd.608] Cam auto-generation request	<ul style="list-style-type: none"> <li>Set the request for cam auto-generation.</li> <li>The Simple Motion module resets the value to "0" automatically after completion of the cam auto-generation.</li> </ul> Fetch cycle: <u>Main cycle</u> (Note-1)	<ul style="list-style-type: none"> <li>Set in decimal.</li> <li>1: Cam auto-generation request</li> </ul>	0	53200
[Cd.609] Cam auto-generation cam No.	<ul style="list-style-type: none"> <li>Set the cam No. to be generated automatically.</li> </ul> Fetch cycle: <u>At requesting cam auto-generation</u>	<ul style="list-style-type: none"> <li>Set in decimal.</li> <li>1 to 256</li> </ul>	0	53201
[Cd.610] Cam auto-generation type	<ul style="list-style-type: none"> <li>Set the type of cam auto-generation.</li> </ul> Fetch cycle: <u>At requesting cam auto-generation</u>	<ul style="list-style-type: none"> <li>Set in decimal.</li> <li>1: Cam for rotary cutter</li> </ul>	0	53202
[Cd.611] Cam auto-generation data	<ul style="list-style-type: none"> <li>Set the parameters for each type of cam auto-generation.</li> </ul> Fetch cycle: <u>At requesting cam auto-generation</u>	(Refer to the next page)	0	53204 to 53779

(Note-1): With the exception of positioning control, main cycle processing is executed during the next available time. It changes by status of axis start.

#### [Cd.608] Cam auto-generation request

Set "1: Cam auto-generation request" to execute cam auto-generation.

Cam data is generated in the cam open area of the specified cam No. based on the cam auto-generation data.

The setting value is reset to "0" automatically after completing the process.

The cam auto-generation data is saved in the cam storage area. The cam auto-generation is executed automatically again when the next power supply turns ON or PLC READY signal [Y0] OFF to ON.

If a warning occurs when requesting cam auto-generation, the warning number is stored in "[Md.24] Axis warning No." of axis 1, and the setting value is reset to "0" automatically.

When another request command is set, this function does not get executed and the setting value is reset to "0" automatically.

## [Cd.609] Cam auto-generation cam No.

Set the cam No. to be generated automatically.

## [Cd.610] Cam auto-generation type

Set the type of cam auto-generation.

## [Cd.611] Cam auto-generation data

Set the cam auto-generation data corresponding to "[Cd.610] Cam auto-generation type".

## 1) For a rotary cutter

The cam data starting point for a rotary cutter is 0.

Buffer memory address	Item	Setting value	Details
53204	Cam resolution	256/512/1024/2048/ 4096/8192/16384/32768	Set the cam resolution for generating the cam.
53206 53207	Sheet length	1 to 2147483647 [(Optional) Same unit (0.1mm, etc.)]	Set the sheet length. Set this value in the cam axis length per cycle.
53208 53209	Sheet synchronization width	1 to 2147483647 [(Optional) Same unit (0.1mm, etc.)]	Set the sheet length of the synchronous section.
53210 53211	Synchronous axis length	1 to 2147483647 [(Optional) Same unit (0.1mm, etc.)]	Set the cycle length of the rotary cutter shaft.
53212 53213	Synchronization starting point	0 to 2147483647 [(Optional) Same unit (0.1mm, etc.)]	Set the length from the beginning of the sheet to the start of the synchronous section.
53214	Synchronous section acceleration ratio	-5000 to 5000 [0.01%]	Set when the synchronous speed in the synchronous section needs to be adjusted. The speed is "Synchronous speed × (100% + Acceleration ratio)" in the synchronous section.



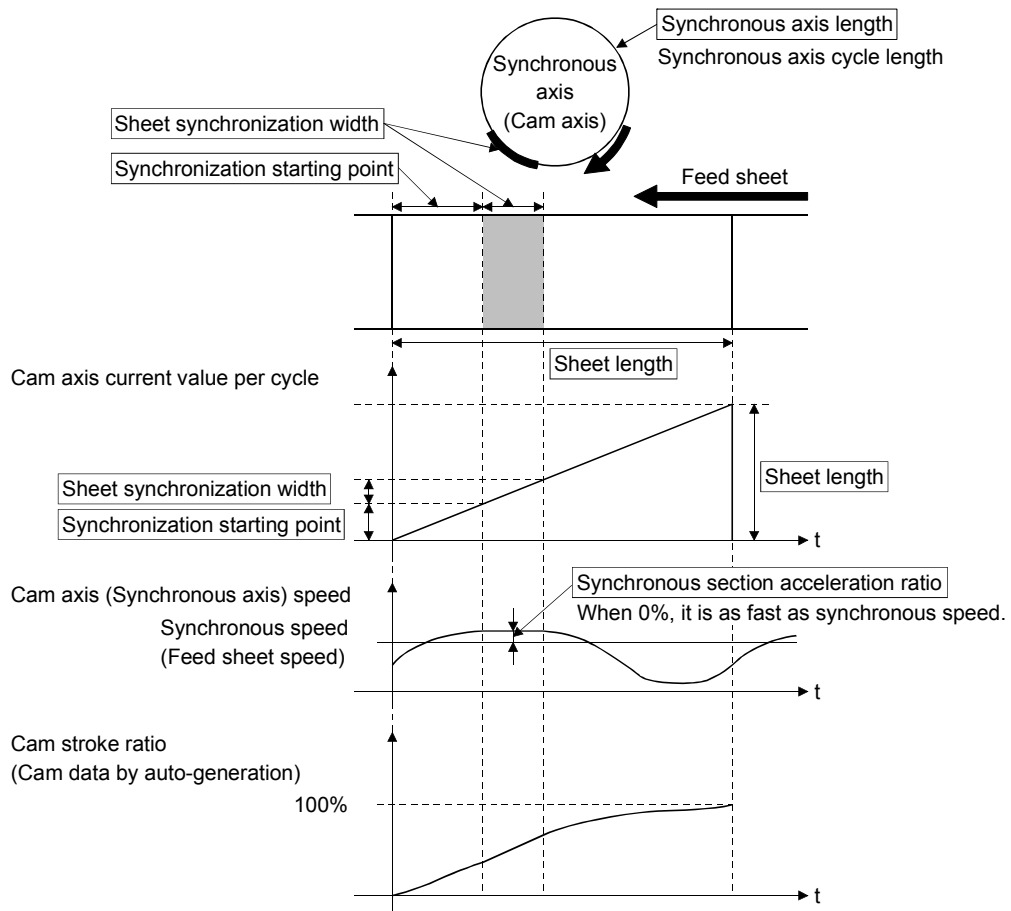



# Chapter 4 Synchronous Control

The parameters and monitor data for synchronous control such as "Main shaft module", "Speed change gear module", and "Output axis module" are explained in this chapter.

Configure the required settings according to the control and application requirements for each module.

4.1	Main shaft module.....	4- 2
4.1.1	Overview of main shaft module.....	4- 2
4.1.2	Main shaft parameters .....	4- 3
4.1.3	Main shaft clutch parameters.....	4- 6
4.1.4	Main shaft clutch control data .....	4-14
4.2	Auxiliary shaft module.....	4-15
4.2.1	Overview of auxiliary shaft module .....	4-15
4.2.2	Auxiliary shaft parameters .....	4-16
4.2.3	Auxiliary shaft clutch parameters.....	4-19
4.2.4	Auxiliary shaft clutch control data .....	4-27
4.3	Clutch.....	4-28
4.3.1	Overview of clutch.....	4-28
4.3.2	Control method for clutch.....	4-28
4.3.3	Smoothing method for clutch .....	4-35
4.3.4	Use example of clutch.....	4-40
4.4	Speed change gear module.....	4-41
4.4.1	Overview of speed change gear module .....	4-41
4.4.2	Speed change gear parameters .....	4-42
4.5	Output axis module .....	4-44
4.5.1	Overview of output axis module.....	4-44
4.5.2	Output axis parameters.....	4-46
4.6	Synchronous control change function.....	4-50
4.6.1	Overview of synchronous control change function .....	4-50
4.6.2	Synchronous control change control data .....	4-51
4.7	Synchronous control monitor data .....	4-56
4.8	Phase compensation function.....	4-61
4.9	Output axis sub functions.....	4-64

## 4.1 Main shaft module

### 4.1.1 Overview of main shaft module

For the main shaft module, the input value is generated as a composite value from two input axes (the main and sub input axis) through the composite main shaft gear. The composite input value can be converted by the main shaft gear that provides the deceleration ratio and the rotation direction for the machine system, etc.

Refer to Section 4.1.2 and Section 4.1.3 for details on setting for the main shaft module.

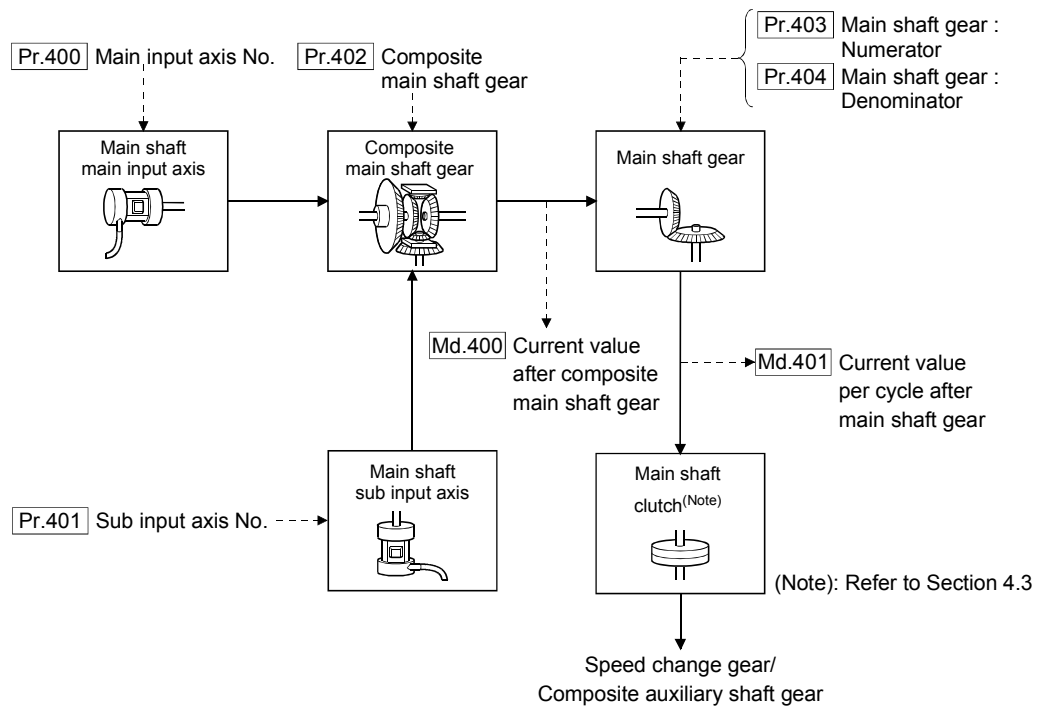

## 4.1.2 Main shaft parameters

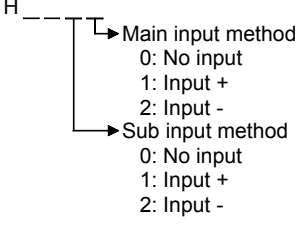
Setting item	Setting details	Setting value	Default value	Buffer memory address
[Pr.400] Main input axis No.	<ul style="list-style-type: none"> <li>Set the input axis No. on the main input side for the main shaft.</li> </ul> <u>Fetch cycle: At start of synchronous control</u>	<ul style="list-style-type: none"> <li>Set in decimal.</li> <li>0 : Invalid</li> <li>1 to 16 : Servo input axis (Note-1)</li> <li>201 to 208 : Command generation axis (Note-2)</li> <li>801 to 804 : Synchronous encoder axis</li> </ul>	0	36400+200n
[Pr.401] Sub input axis No.	<ul style="list-style-type: none"> <li>Set the input axis No. on the sub input side for the main shaft.</li> </ul> <u>Fetch cycle: At start of synchronous control</u>	<ul style="list-style-type: none"> <li>Set in decimal.</li> <li>0 : Invalid</li> <li>1 to 16 : Servo input axis (Note-1)</li> <li>201 to 208 : Command generation axis (Note-2)</li> <li>801 to 804 : Synchronous encoder axis</li> </ul>	0	36401+200n
[Pr.402] Composite main shaft gear	<ul style="list-style-type: none"> <li>Select the composite method for input values from the main input axis and sub input axis.</li> </ul> <u>Fetch cycle: Operation cycle</u>	<ul style="list-style-type: none"> <li>Set in hexadecimal.</li> </ul> 	0001h	36402+200n
[Pr.403] Main shaft gear: Numerator	<ul style="list-style-type: none"> <li>Set the numerator for the main shaft gear.</li> </ul> <u>Fetch cycle: At start of synchronous control</u>	<ul style="list-style-type: none"> <li>Set in decimal.</li> <li>-2147483648 to 2147483647</li> </ul>	1	36404+200n 36405+200n
[Pr.404] Main shaft gear: Denominator	<ul style="list-style-type: none"> <li>Set the denominator for the main shaft gear.</li> </ul> <u>Fetch cycle: At start of synchronous control</u>	<ul style="list-style-type: none"> <li>Set in decimal.</li> <li>1 to 2147483647</li> </ul>	1	36406+200n 36407+200n

n: Axis No.-1

(Note-1): The range from axis 1 to 2 is valid in the 2-axis module, from axis 1 to 4 is valid in the 4-axis module, from axis 1 to 8 is valid in the 8-axis module, and from axis 1 to 16 is valid in the 16-axis module.

(Note-2): The range from axis 1 to 2 is valid in the 2-axis module, from axis 1 to 4 is valid in the 4-axis module and from axis 1 to 8 is valid in the 8/16-axis module.

[Pr.400] Main input axis No., [Pr.401] Sub input axis No.

Set the main input axis No. and the sub input axis No. for the main shaft.

0: Invalid..... The input value is always 0.

1 to 16: Servo input axis <sup>(Note-1)</sup> .. Set the servo input axis (axis 1 to axis 16). When the servo input axis is not set in the system setting, the input value is always 0.  
If the number is set to the same value as the output axis, the following errors occur and synchronous control cannot be started.

- Outside main input axis No. range (error code: 700)
- Outside sub input axis No. range (error code: 701)

201 to 208: Command generation axis <sup>(Note-2)</sup>

..... Set the command generation axis (axis 1 to axis 8).  
When the command generation axis is invalid in the command generation axis parameter setting, the input value is always 0.

801 to 804: Synchronous encoder axis

..... Set the synchronous encoder axis (axis 1 to axis 4).  
When synchronous encoder axis is invalid, the input value is always 0.

(Note-1): The range from axis 1 to 2 is valid in the 2-axis module, from axis 1 to 4 is valid in the 4-axis module, from axis 1 to 8 is valid in the 8-axis module, and from axis 1 to 16 is valid in the 16-axis module.

(Note-2): The range from axis 1 to 2 is valid in the 2-axis module, from axis 1 to 4 is valid in the 4-axis module and from axis 1 to 8 is valid in the 8/16-axis module.

[Pr.402] Composite main shaft gear

Set the composite method for input values from the main and sub input axes. The setting values for each axis are shown as follows.

0: No input..... The input value from the input axis is calculated as 0.

1: Input+ ..... The input value from the input axis is calculated as it is.

2: Input- ..... The input value from the input axis is calculated with its opposite sign.

Operation assumes "0: No input" if the value is set out of the range from 0 to 2.

<b>POINT</b>
The composite method for the composite main shaft gear can be changed during synchronous control. It is used as a clutch to switch input values between the main and the sub input axes.

[Pr.403] Main shaft gear: Numerator, [Pr.404] Main shaft gear: Denominator

Set the numerator and the denominator for the main shaft gear to convert the input value.  
The input value is converted as follows.

$$\text{Input value after conversion} = \text{Input value before conversion} \times \frac{\boxed{\text{Pr.403}} \text{ Main shaft gear: Numerator}}{\boxed{\text{Pr.404}} \text{ Main shaft gear: Denominator}}$$

The input value direction can be reversed by setting a negative value in the numerator of the main shaft gear.

Set the denominator of the main shaft gear to a value within the range from 1 to 2147483647.

Example) Convert the cam axis per cycle to be controlled in intervals of 0.1 mm (0.00394 inch).

The cam axis synchronizes with a conveyer that moves 100 mm (3.937 inch) for every (360.00000 degree) of the main shaft.

"[Pr.403] Main shaft gear: Numerator" : 1000 [ $\times 0.1$  mm]

"[Pr.404] Main shaft gear: Denominator": 36000000 [ $\times 10^{-5}$  degree]

## 4.1.3 Main shaft clutch parameters

Setting item	Setting details	Setting value	Default value	Buffer memory address
[Pr.405] Main shaft clutch control setting	<ul style="list-style-type: none"> <li>Set the control method for the clutch.</li> </ul> <u>Fetch cycle: Operation cycle</u>	<p>■ Set in hexadecimal.</p>  <p>ON control mode  0: No clutch  1: Clutch command ON/OFF  2: Clutch command leading edge  3: Clutch command trailing edge  4: Address mode  5: High speed input request</p> <p>OFF control mode  0: OFF control invalid  1: One-shot OFF  2: Clutch command leading edge  3: Clutch command trailing edge  4: Address mode  5: High speed input request</p> <p>High speed input request signal  0 to F: High speed input request signal from axis 1 to axis 16<sup>(Note-1)</sup></p>	0000h	36408+200n
[Pr.406] Main shaft clutch reference address setting	<ul style="list-style-type: none"> <li>Set the reference address for the clutch.</li> </ul> <u>Fetch cycle: At start of synchronous control</u>	<p>■ Set in decimal.</p> 0: Current value after composite main shaft gear 1: Current value per cycle after main shaft gear	0	36409+200n
[Pr.407] Main shaft clutch ON address	<ul style="list-style-type: none"> <li>Set the clutch ON address for address mode. (This setting is invalid except during address mode.)</li> <li>If the address is out of the range from 0 to (Cam axis length per cycle - 1), the address is converted to a value within range.</li> </ul> <u>Fetch cycle: Operation cycle</u>	<p>■ Set in decimal.</p> -2147483648 to 2147483647 [Main input axis position units <sup>(Note-2)</sup> , or cam axis cycle units <sup>(Note-3)</sup> ]	0	36410+200n 36411+200n
[Pr.408] Travel value before main shaft clutch ON	<ul style="list-style-type: none"> <li>Set the travel value for the distance between the clutch ON condition completing and the clutch closing.</li> <li>Set a positive value when the reference address is increasing, and a negative value when it is decreasing.</li> </ul> <u>Fetch cycle: At completing clutch ON condition</u>	<p>■ Set in decimal.</p> -2147483648 to 2147483647 [Main input axis position units <sup>(Note-2)</sup> , or cam axis cycle units <sup>(Note-3)</sup> ]	0	36412+200n 36413+200n

n: Axis No.-1

(Note-1): The range from axis 1 to 2 is valid in the 2-axis module, from axis 1 to 4 is valid in the 4-axis module, from axis 1 to 8 is valid in the 8-axis module, and from axis 1 to 16 is valid in the 16-axis module.

(Note-2): Main input axis position units (Refer to Chapter 2)

(Note-3): Cam axis cycle units (Refer to Section 4.5.1)



Setting item	Setting details	Setting value	Default value	Buffer memory address
[Pr.409] Main shaft clutch OFF address	<ul style="list-style-type: none"> <li>Set the clutch OFF address for the address mode. (This setting is invalid except during address mode.)</li> <li>If the address is out of the range from 0 to (Cam axis length per cycle - 1), the setting address is converted to a value within range.</li> </ul> <u>Fetch cycle: Operation cycle</u>	<ul style="list-style-type: none"> <li>Set in decimal.</li> <li>-2147483648 to 2147483647</li> <li>[Main input axis position units <sup>(Note-2)</sup>, or cam axis cycle units <sup>(Note-3)</sup>]</li> </ul>	0	36414+200n 36415+200n
[Pr.410] Travel value before main shaft clutch OFF	<ul style="list-style-type: none"> <li>Set the travel value for the distance between the clutch OFF condition completing and the clutch opening.</li> <li>Set a positive value when the reference address is increasing, and a negative value when it is decreasing.</li> </ul> <u>Fetch cycle: At completing clutch OFF condition</u>	<ul style="list-style-type: none"> <li>Set in decimal.</li> <li>-2147483648 to 2147483647</li> <li>[Main input axis position units <sup>(Note-2)</sup>, or cam axis cycle units <sup>(Note-3)</sup>]</li> </ul>	0	36416+200n 36417+200n
[Pr.411] Main shaft clutch smoothing method	<ul style="list-style-type: none"> <li>Set the clutch smoothing method.</li> </ul> <u>Fetch cycle: At start of synchronous control</u>	<ul style="list-style-type: none"> <li>Set in decimal.</li> <li>0: Direct</li> <li>1: Time constant method (Exponent)</li> <li>2: Time constant method (Linear)</li> <li>3: Slippage method (Exponent)</li> <li>4: Slippage method (Linear)</li> </ul>	0	36418+200n
[Pr.412] Main shaft clutch smoothing time constant	<ul style="list-style-type: none"> <li>For smoothing with a time constant method, set the smoothing time constant.</li> </ul> <u>Fetch cycle: At start of synchronous control</u>	<ul style="list-style-type: none"> <li>Set in decimal.</li> <li>0 to 5000 [ms]</li> </ul>	0	36419+200n
[Pr.413] Slippage amount at main shaft clutch ON	<ul style="list-style-type: none"> <li>For smoothing with a slippage method, set the slippage amount at clutch ON.</li> </ul> <u>Fetch cycle: At turning clutch ON.</u>	<ul style="list-style-type: none"> <li>Set in decimal.</li> <li>0 to 2147483647</li> <li>[Main input axis position units <sup>(Note-2)</sup>, or cam axis cycle units <sup>(Note-3)</sup>]</li> </ul>	0	36420+200n 36421+200n
[Pr.414] Slippage amount at main shaft clutch OFF	<ul style="list-style-type: none"> <li>For smoothing with a slippage method, set the slippage amount at clutch OFF.</li> </ul> <u>Fetch cycle: At turning clutch OFF.</u>	<ul style="list-style-type: none"> <li>Set in decimal.</li> <li>0 to 2147483647</li> <li>[Main input axis position units <sup>(Note-2)</sup>, or cam axis cycle units <sup>(Note-3)</sup>]</li> </ul>	0	36422+200n 36423+200n

n: Axis No.-1

(Note-2): Main input axis position units (Refer to Chapter 2)

(Note-3): Cam axis cycle units (Refer to Section 4.5.1)

**[Pr.405] Main shaft clutch control setting**

Set the ON and OFF control methods separately for the main shaft clutch.

The clutch control setting can be changed during synchronous control, however, the setting "No clutch" (Direct coupled operation) cannot be selected during synchronous control after already selecting another setting.

Refer to Section 4.3.2 for operation details on the clutch control.

**(1) ON control mode**

- 0: No clutch (Direct coupled operation) ...Execute direct coupled operation without clutch control.
- 1: Clutch command ON/OFF .....The clutch is turned ON/OFF by the operation of "[Cd.400] Main shaft clutch command" ON/OFF. (Setting in the OFF control mode are not applicable in this mode.)
- 2: Clutch command leading edge .....The clutch is turned ON when "[Cd.400] Main shaft clutch command" passes the leading edge (from OFF to ON).
- 3: Clutch command trailing edge .....The clutch is turned ON when "[Cd.400] Main shaft clutch command" passes the trailing edge (from ON to OFF).
- 4: Address mode .....The clutch is turned ON when the reference address (the current value after composite main shaft gear or the current value per cycle after main shaft gear) reaches "[Pr.407] Main shaft clutch ON address". The travel value after passing through the ON address is calculated as the output travel value of the clutch based on the reference address passing through, thereby controlling the clutch with an accurate travel value.
- 5: High speed input request .....The clutch is turned ON when the high speed input request [DI] turns ON.

**POINT**

Other clutch parameters are not applicable during direct coupled operation by setting "0: No clutch". "[Cd.402] Main shaft clutch forced OFF command" and the change of the clutch control setting are ignored during direct coupled operation.

(2) OFF control mode

- 0: OFF control invalid .....Clutch OFF control is not used. This setting is applicable only for execution with clutch ON control.
- 1: One-shot OFF .....The clutch is turned OFF after moving the distance "[Pr.410] Travel value before main shaft clutch OFF" (One-shot operation) after the clutch command turns ON.  
If "[Pr.410] Travel value before main shaft clutch OFF" is 0, "[Md.420] Main shaft clutch ON/OFF status" does not turn ON in order to turn back OFF immediately.
- 2: Clutch command leading edge .....The clutch is turned OFF when "[Cd.400] Main shaft clutch command" passes the leading edge (from OFF to ON).
- 3: Clutch command trailing edge .....The clutch is turned OFF when "[Cd.400] Main shaft clutch command" passes the trailing edge (from ON to OFF).
- 4: Address mode .....The clutch is turned OFF when the reference address (the current value after composite main shaft gear or the current value per cycle after main shaft gear) reaches "[Pr.409] Main shaft clutch OFF address".  
The travel value before passing through the OFF address is calculated as the output travel value of the clutch based on the reference address passing through, thereby controlling the clutch with an accurate travel value.
- 5: High speed input request .....The clutch is turned OFF when the high speed input request [DI] turns ON.

(3) High speed input request signal

Set the high speed input request signal No. for the ON control mode (1) and the OFF control mode (2) when using the setting "5: High speed input request".

Signal No.	Setting value (Hexadecimal)	Signal No.	Setting value (Hexadecimal)	Signal No.	Setting value (Hexadecimal)	Signal No.	Setting value (Hexadecimal)
1	0	5	4	9	8	13	C
2	1	6	5	10	9	14	D
3	2	7	6	11	A	15	E
4	3	8	7	12	B	16	F

**[Pr.406] Main shaft clutch reference address setting**

Select the address type to be used as the reference address for clutch control. Note that the processing order of the main shaft gear and the main shaft clutch will change depending on the reference address setting.

0: Current value after composite main shaft gear

..... The clutch is controlled by using the current value after composite main shaft gear as a reference.  
Output after the clutch is a converted travel value through the main shaft gear.

1: Current value per cycle after main shaft gear

..... The clutch is controlled by using the current value per cycle after main shaft gear.  
Output after the clutch is a travel value without conversion.

The setting values for the following parameters are in units based on the reference address setting.

- "[Pr.407] Main shaft clutch ON address"
- "[Pr.409] Main shaft clutch OFF address"
- "[Pr.408] Travel value before main shaft clutch ON", "[Pr.410] Travel value before main shaft clutch OFF"
- "[Pr.413] Slippage amount at main shaft clutch ON", "[Pr.414] Slippage amount at main shaft clutch OFF"

**[Pr.407] Main shaft clutch ON address**

Set the clutch ON address when address mode is configured for the ON control mode of the main shaft clutch.

When the reference address is the current value per cycle after main shaft gear, the setting address is converted for control within the range from 0 to (Cam axis length per cycle - 1).

Example) Cam axis length per cycle: 20000PLS

The ON address is controlled as 19000PLS when the setting value is "-1000".

[Pr.408] Travel value before main shaft clutch ON

Set the travel value of the reference address with a signed value between the clutch ON condition completing and the clutch closing.

1 to 2147483647 (Positive value).....Used when the reference address is increasing in direction.

0.....No movement amount (The clutch is immediately turned ON with the clutch ON condition completing.)

-2147483648 to -1(Negative value).....Used when the reference address is decreasing in direction.

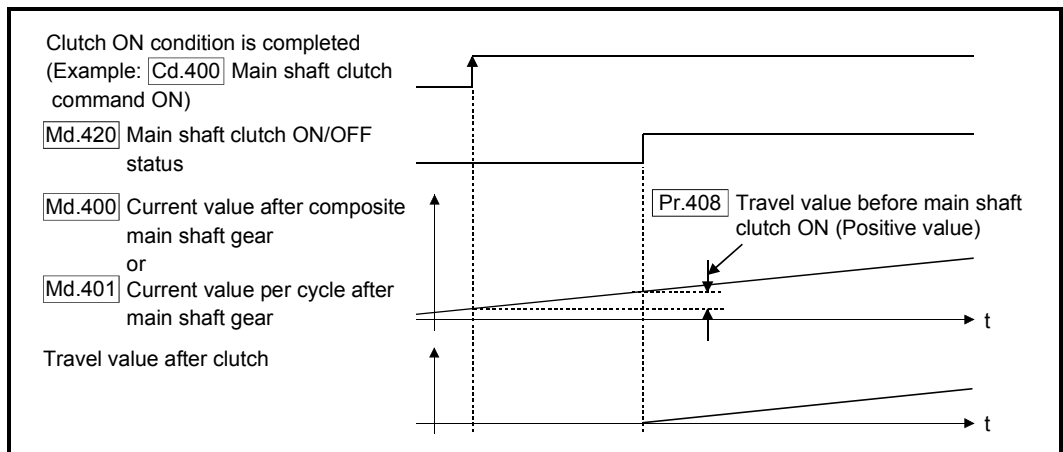

[Pr.409] Main shaft clutch OFF address

Set the clutch OFF address when address mode is configured for the OFF control mode of the main shaft clutch.

When the reference address is the current value per cycle after main shaft gear, the setting address is converted for control within the range from 0 to (Cam axis length per cycle - 1).

Example) Cam axis length per cycle: 20000PLS

The OFF address is controlled as 60PLS when the setting value is "40060".

[Pr.410] Travel value before main shaft clutch OFF

Set the travel value of the reference address with a signed value between the clutch OFF condition completing and the clutch opening.

- 1 to 2147483647 (Positive value).....Used when the reference address is increasing in direction.
- 0.....No movement amount (The clutch is immediately turned OFF with the clutch OFF condition completing.)
- 2147483648 to -1(Negative value).....Used when the reference address is decreasing in direction.

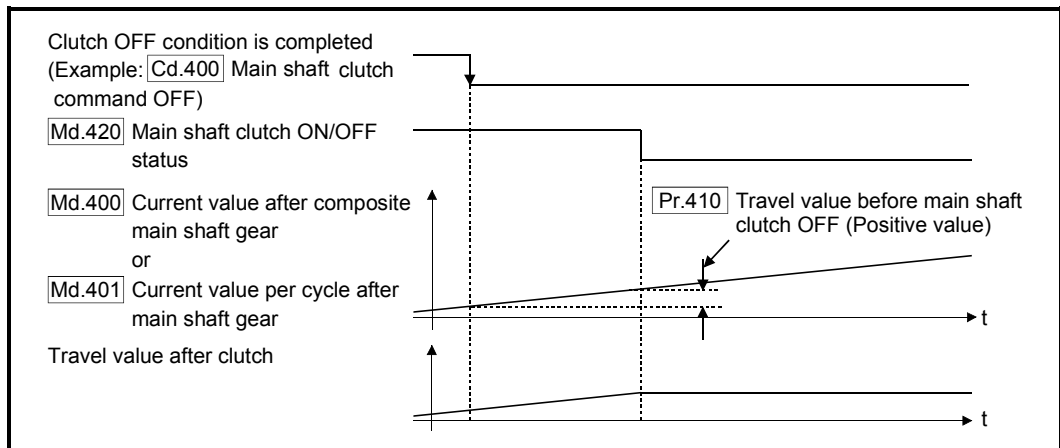

[Pr.411] Main shaft clutch smoothing method

Set the smoothing method for clutch ON/OFF.

Refer to Section 4.3.3 for details.

- 0: Direct..... No smoothing
- 1: Time constant method (Exponent) ..... Smoothing with an exponential curve based on the time constant setting.
- 2: Time constant method (Linear)..... Smoothing with linear acceleration/deceleration based on the time constant setting.
- 3: Slippage method (Exponent) ..... Smoothing with an exponential curve based on the slippage amount setting.
- 4: Slippage method (Linear)..... Smoothing with linear acceleration/deceleration based on the slippage amount setting.

[Pr.412] Main shaft clutch smoothing time constant

Set a time constant when the time constant method is set in "[Pr.411] Main shaft clutch smoothing method".

The time constant setting applies for clutch ON/OFF.

[Pr.413] Slippage amount at main shaft clutch ON

Set the slippage amount at clutch ON when the slippage method is set in "[Pr.411] Main shaft clutch smoothing method".

The slippage amount is set in units based on the current value selected in "[Pr.406] Main shaft clutch reference address setting".

If the set amount is negative, slippage amount at clutch ON is controlled as 0 (direct).

[Pr.414] Slippage amount at main shaft clutch OFF

Set the slippage amount at clutch OFF when the slippage method is set in "[Pr.411] Main shaft clutch smoothing method".

The slippage amount is set in units based on the current value selected in "[Pr.406] Main shaft clutch reference address setting".

If the set amount is negative, slippage amount at clutch OFF is controlled as 0 (direct).

## 4.1.4 Main shaft clutch control data

Setting item	Setting details	Setting value	Default value	Buffer memory address
[Cd.400] Main shaft clutch command	• Set the clutch command ON/OFF. <u>Fetch cycle: Operation cycle</u>	■ Set in decimal. 0: Main shaft clutch command OFF 1: Main shaft clutch command ON	0	44080+20n
[Cd.401] Main shaft clutch control invalid command	• Set "1" to disable the clutch control temporarily. <u>Fetch cycle: Operation cycle</u>	■ Set in decimal. 0: Main shaft clutch control valid 1: Main shaft clutch control invalid	0	44081+20n
[Cd.402] Main shaft clutch forced OFF command	• Set "1" to force the clutch OFF. <u>Fetch cycle: Operation cycle</u>	■ Set in decimal. 0: Main shaft clutch normal control 1: Main shaft clutch forced OFF	0	44082+20n

n: Axis No.-1

**[Cd.400] Main shaft clutch command**

Use ON/OFF for the main shaft clutch command. This command is used with the following settings.

- The clutch ON control mode is "1: Clutch command ON/OFF", "2: Clutch command leading edge" or "3: Clutch command trailing edge".
- The clutch OFF control mode is either "2: Clutch command leading edge" or "3: Clutch command trailing edge".

Status is considered as clutch command OFF just before starting synchronous control. If synchronous control is started while the clutch command is ON, the condition is established just after starting synchronous control, by setting "2: Clutch command leading edge". The condition is not established just after starting, by setting "3: Clutch command trailing edge".

**[Cd.401] Main shaft clutch control invalid command**

The main shaft clutch control is invalid if "1" is set. The previous clutch ON/OFF status remains before clutch control becomes invalid.

Clutch control will not become invalid during the movement before clutch ON and clutch OFF. Instead, clutch control will become invalid after movement is completed.

**[Cd.402] Main shaft clutch forced OFF command**

Set "1" to force the clutch OFF. The output value from the clutch becomes 0 immediately, even during clutch smoothing. The slippage (accumulative) amount is set to 0 if smoothing with a slippage method.

Reset to "0" to restart the clutch control from the clutch OFF status after using the clutch forced OFF command.



## 4.2 Auxiliary shaft module

### 4.2.1 Overview of auxiliary shaft module

For the auxiliary shaft module, the input value is generated from the auxiliary shaft. The input value can be converted by the auxiliary shaft gear that provides the deceleration ratio and the rotation direction for the machine system, etc.

Refer to Section 4.2.2 and Section 4.2.3 for details on setting for the auxiliary shaft module.

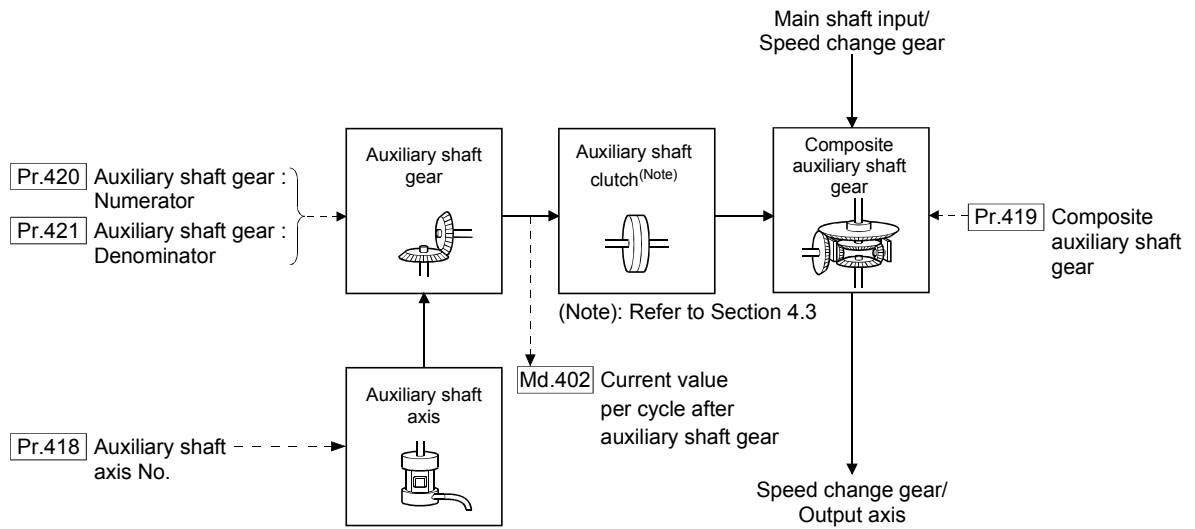

## 4.2.2 Auxiliary shaft parameters

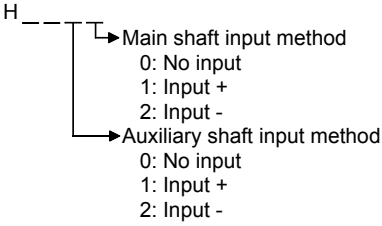
Setting item	Setting details	Setting value	Default value	Buffer memory address
[Pr.418] Auxiliary shaft axis No.	<ul style="list-style-type: none"> <li>Set the input axis No. for the auxiliary shaft.</li> </ul> Fetch cycle: <u>At start of synchronous control</u>	<ul style="list-style-type: none"> <li>Set in decimal.</li> <li>0 : Invalid</li> <li>1 to 16 : Servo input axis (Note-1)</li> <li>201 to 208 : Command generation axis (Note-2)</li> <li>801 to 804 : Synchronous encoder axis</li> </ul>	0	36430+200n
[Pr.419] Composite auxiliary shaft gear	<ul style="list-style-type: none"> <li>Select the composite method for input values from the main shaft and the auxiliary shaft.</li> </ul> Fetch cycle: <u>Operation cycle</u>	<ul style="list-style-type: none"> <li>Set in hexadecimal.</li> </ul> 	0001h	36431+200n
[Pr.420] Auxiliary shaft gear: Numerator	<ul style="list-style-type: none"> <li>Set the numerator for the auxiliary shaft gear.</li> </ul> Fetch cycle: <u>At start of synchronous control</u>	<ul style="list-style-type: none"> <li>Set in decimal.</li> <li>-2147483648 to 2147483647</li> </ul>	1	36432+200n 36433+200n
[Pr.421] Auxiliary shaft gear: Denominator	<ul style="list-style-type: none"> <li>Set the denominator for the auxiliary shaft gear.</li> </ul> Fetch cycle: <u>At start of synchronous control</u>	<ul style="list-style-type: none"> <li>Set in decimal.</li> <li>1 to 2147483647</li> </ul>	1	36434+200n 36435+200n

n: Axis No.-1

(Note-1): The range from axis 1 to 2 is valid in the 2-axis module, from axis 1 to 4 is valid in the 4-axis module, from axis 1 to 8 is valid in the 8-axis module, and from axis 1 to 16 is valid in the 16-axis module.

(Note-2): The range from axis 1 to 2 is valid in the 2-axis module, from axis 1 to 4 is valid in the 4-axis module and from axis 1 to 8 is valid in the 8/16-axis module.

[Pr.418] Auxiliary shaft axis No.

Set the input axis No. for the auxiliary shaft.

- 0: Invalid..... The input value is always 0.
- 1 to 16: Servo input axis <sup>(Note-1)</sup> .. Set the servo input axis (axis 1 to axis 16). When the servo input axis is not set in the system setting, the input value is always 0.  
If the number is set to the same value as the output axis, the error "Outside auxiliary shaft axis No. range" (error code: 720) occurs and synchronous control cannot be started.
- 201 to 208: Command generation axis <sup>(Note-2)</sup>  
..... Set the command generation axis (axis 1 to axis 8).  
When the command generation axis is invalid in the command generation axis parameter setting, the input value is always 0.
- 801 to 804: Synchronous encoder axis  
..... Set the synchronous encoder axis (axis 1 to axis 4).  
When synchronous encoder axis is invalid, the input value is always 0.

(Note-1): The range from axis 1 to 2 is valid in the 2-axis module, from axis 1 to 4 is valid in the 4-axis module, from axis 1 to 8 is valid in the 8-axis module, and from axis 1 to 16 is valid in the 16-axis module.

(Note-2): The range from axis 1 to 2 is valid in the 2-axis module, from axis 1 to 4 is valid in the 4-axis module and from axis 1 to 8 is valid in the 8/16-axis module.

[Pr.419] Composite auxiliary shaft gear

Set the composite method for input values from the main and auxiliary shafts. The setting values for each axis are shown as follows.

- 0: No input..... The input value from the input axis is calculated as 0.
- 1: Input+ ..... The input value from the input axis is calculated as it is.
- 2: Input- ..... The input value from the input axis is calculated with its opposite sign.

Operation assumes "0: No input" if the value is set out of the range from 0 to 2.

<b>POINT</b>
The composite method for the composite auxiliary shaft gear can be changed during synchronous control. It is used as a clutch to switch input values between the main and the auxiliary shafts.

[Pr.420] Auxiliary shaft gear: Numerator, [Pr.421] Auxiliary shaft gear: Denominator

Set the numerator and the denominator for auxiliary shaft gear to convert the input value.  
The input value is converted as follows.

Input value after conversion = Input value before conversion  $\times$

$$\frac{\boxed{\text{Pr.420}} \text{ Auxiliary shaft gear: Numerator}}{\boxed{\text{Pr.421}} \text{ Auxiliary shaft gear: Denominator}}$$

The input value direction can be reversed by setting a negative value in the numerator of the auxiliary shaft gear.

Set the denominator of the auxiliary shaft gear to a value within the range from 1 to 2147483647.

4.2.3 Auxiliary shaft clutch parameters

Setting item	Setting details	Setting value	Default value	Buffer memory address
[Pr.422] Auxiliary shaft clutch control setting	<ul style="list-style-type: none"> <li>Set the control method for the clutch. <u>Fetch cycle: Operation cycle</u></li> </ul>	<p>■ Set in hexadecimal.</p> <p>ON control mode                      0: No clutch                      1: Clutch command ON/OFF                      2: Clutch command leading edge                      3: Clutch command trailing edge                      4: Address mode                      5: High speed input request</p> <p>OFF control mode                      0: OFF control invalid                      1: One-shot OFF                      2: Clutch command leading edge                      3: Clutch command trailing edge                      4: Address mode                      5: High speed input request</p> <p>High speed input request signal                      0 to F: High speed input request signal from axis 1 to axis 16<sup>(Note-1)</sup></p>	0000h	36436+200n
[Pr.423] Auxiliary shaft clutch reference address setting	<ul style="list-style-type: none"> <li>Set the reference address for the clutch. <u>Fetch cycle: At start of synchronous control</u></li> </ul>	<p>■ Set in decimal.</p> <p>0: Auxiliary shaft current value                      1: Current value per cycle after auxiliary shaft gear</p>	0	36437+200n
[Pr.424] Auxiliary shaft clutch ON address	<ul style="list-style-type: none"> <li>Set the clutch ON address for address mode. (This setting is invalid except during address mode.)</li> <li>If the address is out of the range from 0 to (Cam axis length per cycle - 1), the address is converted to a value within range. <u>Fetch cycle: Operation cycle</u></li> </ul>	<p>■ Set in decimal.</p> <p>-2147483648 to 2147483647                      [Auxiliary shaft position units<sup>(Note-2)</sup>, or cam axis cycle units<sup>(Note-3)</sup>]</p>	0	36438+200n 36439+200n
[Pr.425] Travel value before auxiliary shaft clutch ON	<ul style="list-style-type: none"> <li>Set the travel value for the distance between the clutch ON condition completing and the clutch closing.</li> <li>Set a positive value when the reference address is increasing, and a negative value when it is decreasing. <u>Fetch cycle: At completing clutch ON condition</u></li> </ul>	<p>■ Set in decimal.</p> <p>-2147483648 to 2147483647                      [Auxiliary shaft position units<sup>(Note-2)</sup>, or cam axis cycle units<sup>(Note-3)</sup>]</p>	0	36440+200n 36441+200n

n: Axis No.-1

(Note-1): The range from axis 1 to 2 is valid in the 2-axis module, from axis 1 to 4 is valid in the 4-axis module, from axis 1 to 8 is valid in the 8-axis module, and from axis 1 to 16 is valid in the 16-axis module.

(Note-2): Auxiliary shaft position units (Refer to Chapter 2)

(Note-3): Cam axis cycle units (Refer to Section 4.5.1)

Setting item	Setting details	Setting value	Default value	Buffer memory address
[Pr.426] Auxiliary shaft clutch OFF address	<ul style="list-style-type: none"> <li>Set the clutch OFF address for the address mode. (This setting is invalid except during address mode.)</li> <li>If the address is out of the range from 0 to (Cam axis length per cycle - 1), the setting address is converted to a value within range.</li> </ul> <u>Fetch cycle: Operation cycle</u>	<ul style="list-style-type: none"> <li>Set in decimal.</li> <li>-2147483648 to 2147483647</li> <li>[Auxiliary shaft position units <sup>(Note-2)</sup>, or cam axis cycle units <sup>(Note-3)</sup>]</li> </ul>	0	36442+200n 36443+200n
[Pr.427] Travel value before auxiliary shaft clutch OFF	<ul style="list-style-type: none"> <li>Set the travel value for the distance between the clutch OFF condition completing and the clutch opening.</li> <li>Set a positive value when the reference address is increasing, and a negative value when it is in decreasing.</li> </ul> <u>Fetch cycle: At completing clutch OFF condition</u>	<ul style="list-style-type: none"> <li>Set in decimal.</li> <li>-2147483648 to 2147483647</li> <li>[Auxiliary shaft position units <sup>(Note-2)</sup>, or cam axis cycle units <sup>(Note-3)</sup>]</li> </ul>	0	36444+200n 36445+200n
[Pr.428] Auxiliary shaft clutch smoothing method	<ul style="list-style-type: none"> <li>Set the clutch smoothing method.</li> </ul> <u>Fetch cycle: At start of synchronous control</u>	<ul style="list-style-type: none"> <li>Set in decimal.</li> <li>0: Direct</li> <li>1: Time constant method (Exponent)</li> <li>2: Time constant method (Linear)</li> <li>3: Slippage method (Exponent)</li> <li>4: Slippage method (Linear)</li> </ul>	0	36446+200n
[Pr.429] Auxiliary shaft clutch smoothing time constant	<ul style="list-style-type: none"> <li>For smoothing with a time constant method, set the smoothing time constant.</li> </ul> <u>Fetch cycle: At start of synchronous control</u>	<ul style="list-style-type: none"> <li>Set in decimal.</li> <li>0 to 5000 [ms]</li> </ul>	0	36447+200n
[Pr.430] Slippage amount at auxiliary shaft clutch ON	<ul style="list-style-type: none"> <li>For smoothing with a slippage method, set the slippage amount at clutch ON.</li> </ul> <u>Fetch cycle: At turning clutch ON</u>	<ul style="list-style-type: none"> <li>Set in decimal.</li> <li>0 to 2147483647</li> <li>[Auxiliary shaft position units <sup>(Note-2)</sup>, or cam axis cycle units <sup>(Note-3)</sup>]</li> </ul>	0	36448+200n 36449+200n
[Pr.431] Slippage amount at auxiliary shaft clutch OFF	<ul style="list-style-type: none"> <li>For smoothing with a slippage method, set the slippage amount at clutch OFF.</li> </ul> <u>Fetch cycle: At turning clutch OFF</u>	<ul style="list-style-type: none"> <li>Set in decimal.</li> <li>0 to 2147483647</li> <li>[Auxiliary shaft position units <sup>(Note-2)</sup>, or cam axis cycle units <sup>(Note-3)</sup>]</li> </ul>	0	36450+200n 36451+200n

n: Axis No.-1

(Note-2): Auxiliary shaft position units (Refer to Chapter 2)

(Note-3): Cam axis cycle units (Refer to Section 4.5.1)

**[Pr.422] Auxiliary shaft clutch control setting**

Set the ON and OFF control methods separately for the auxiliary shaft.

The clutch control setting can be changed during synchronous control, however the setting to "No clutch" (Direct coupled operation) cannot be selected during synchronous control after already selecting another setting.

Refer to Section 4.3.2 for operation details on the clutch control.

**(1) ON control mode**

- 0: No clutch (Direct coupled operation) ...Execute direct coupled operation without clutch control.
- 1: Clutch command ON/OFF .....The clutch is turned ON/OFF by the operation of "[Cd.403] Auxiliary shaft clutch command" ON/OFF. (Setting in the OFF control mode are not applicable in this mode.)
- 2: Clutch command leading edge ..... The clutch is turned ON when "[Cd.403] Auxiliary shaft clutch command" passes the leading edge (from OFF to ON).
- 3: Clutch command trailing edge .....The clutch is turned ON when "[Cd.403] Auxiliary shaft clutch command" passes the trailing edge (from ON to OFF).
- 4: Address mode .....The clutch is turned ON when the reference address (the auxiliary shaft current value or the current value per cycle after auxiliary shaft gear) reaches "[Pr.424] Auxiliary shaft clutch ON address".  
The travel value after passing through the ON address is calculated as the output travel value of the clutch based on the reference address passing through, thereby controlling the clutch with an accurate travel value.
- 5: High speed input request .....The clutch is turned ON when the high speed input request [DI] turns ON.

**POINT**

Other clutch parameters are not applicable during direct coupled operation by setting "0: No clutch". "[Cd.405] Auxiliary shaft clutch forced OFF command" and the change of the clutch control setting are ignored during direct coupled operation.

(2) OFF control mode

- 0: OFF control invalid ..... Clutch OFF control is not used. This setting is applicable only for execution with clutch ON control.
- 1: One-shot OFF ..... The clutch is turned OFF after moving the distance "[Pr.427] Travel value before auxiliary shaft clutch OFF" (One-shot operation) after the clutch command turns ON.  
If "[Pr.427] Travel value before auxiliary shaft clutch OFF" is 0, "[Md.423] Auxiliary shaft clutch ON/OFF status" does not turn ON in order to turn back OFF immediately.
- 2: Clutch command leading edge ..... The clutch is turned OFF when "[Cd.403] Auxiliary shaft clutch command" passes the leading edge (from OFF to ON).
- 3: Clutch command trailing edge ..... The clutch is turned OFF when "[Cd.403] Auxiliary shaft clutch command" passes the trailing edge (from ON to OFF).
- 4: Address mode ..... The clutch is turned OFF when the reference address (the auxiliary shaft current value or the current value per cycle after auxiliary shaft gear) reaches "[Pr.426] Auxiliary shaft clutch OFF address".  
The travel value before passing through the OFF address is calculated as the output travel value of the clutch based on the reference address passing through, thereby controlling the clutch with an accurate travel value.
- 5: High speed input request ..... The clutch is turned OFF when the high speed input request [DI] turns ON.

(3) High speed input request signal

Set the high speed input request signal No. for the ON control mode (1) and the OFF control mode (2) when using the setting "5: High speed input request".

Signal No.	Setting value (Hexadecimal)	Signal No.	Setting value (Hexadecimal)	Signal No.	Setting value (Hexadecimal)	Signal No.	Setting value (Hexadecimal)
1	0	5	4	9	8	13	C
2	1	6	5	10	9	14	D
3	2	7	6	11	A	15	E
4	3	8	7	12	B	16	F



**[Pr.423] Auxiliary shaft clutch reference address setting**

Select the address type to be used as the reference address for clutch control. Note that the processing order of the auxiliary shaft gear and the auxiliary shaft clutch will change depending on the reference address setting.

0: Auxiliary shaft current value .... The clutch is controlled by using the current value for the servo input axis/synchronous encoder axis that is set for the auxiliary shaft.

Output after the clutch is a converted travel value through the auxiliary shaft gear.

1: Current value per cycle after auxiliary shaft gear

..... The clutch is controlled by using the current value per cycle after auxiliary shaft gear.

Output after the clutch is a travel value without conversion.

The setting values for the following parameters are in units based on the reference address setting.

- "[Pr.424] Auxiliary shaft clutch ON address"
- "[Pr.426] Auxiliary shaft clutch OFF address"
- "[Pr.425] Travel value before auxiliary shaft clutch ON", "[Pr.427] Travel value before auxiliary shaft clutch OFF"
- "[Pr.430] Slippage amount at auxiliary shaft clutch ON", "[Pr.431] Slippage amount at auxiliary shaft clutch OFF"

**[Pr.424] Auxiliary shaft clutch ON address**

Set the clutch ON address when address mode is configured for the ON control mode of the auxiliary shaft clutch.

When the reference address is the current value per cycle after auxiliary shaft gear, the setting address is converted for control within the range from 0 to (Cam axis length per cycle - 1).

Example) Cam axis length per cycle: 20000PLS

The ON address is controlled as 19000PLS when the setting value is "-1000".

[Pr.425] Travel value before auxiliary shaft clutch ON

Set the travel value of the reference address with a signed value between the clutch ON condition completing and the clutch closing.

1 to 2147483647 (Positive value).....Used when the reference address is increasing in direction.

0.....No movement amount (The clutch is immediately turned ON with the clutch ON condition completing.)

-2147483648 to -1(Negative value).....Used when the reference address is decreasing in direction.

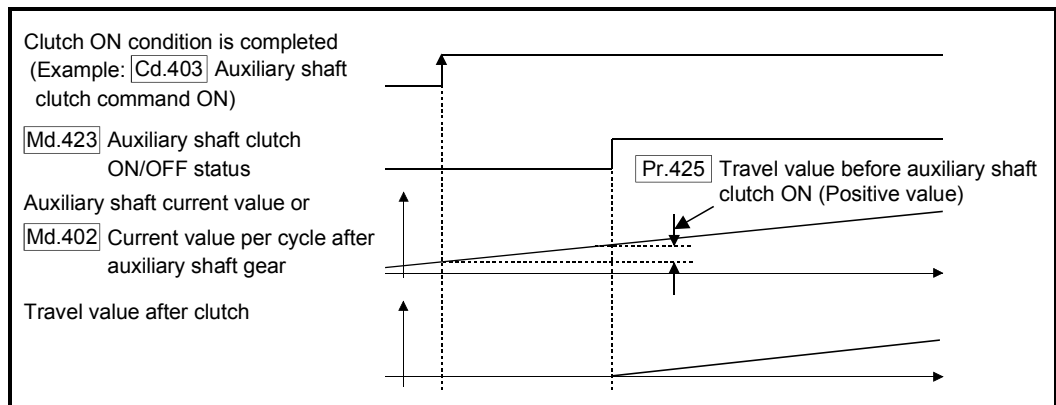

[Pr.426] Auxiliary shaft clutch OFF address

Set the clutch OFF address when address mode is configured for the OFF control mode of the auxiliary shaft clutch.

When the reference address is the current value per cycle after auxiliary shaft gear, the setting address is converted for control within the range from 0 to (Cam axis length per cycle - 1).

Example) Cam axis length per cycle: 20000PLS

The OFF address is controlled as 60PLS when the setting value is "40060".

[Pr.427] Travel value before auxiliary shaft clutch OFF

Set the travel value of the reference address with a signed value between the clutch OFF condition completing and the clutch opening.

- 1 to 2147483647 (Positive value) ..... Used when the reference address is increasing in direction.
- 0 ..... No movement amount (The clutch is immediately turned OFF with the clutch OFF condition completing.)
- 2147483648 to -1(Negative value) ..... Used when the reference address is decreasing in direction.

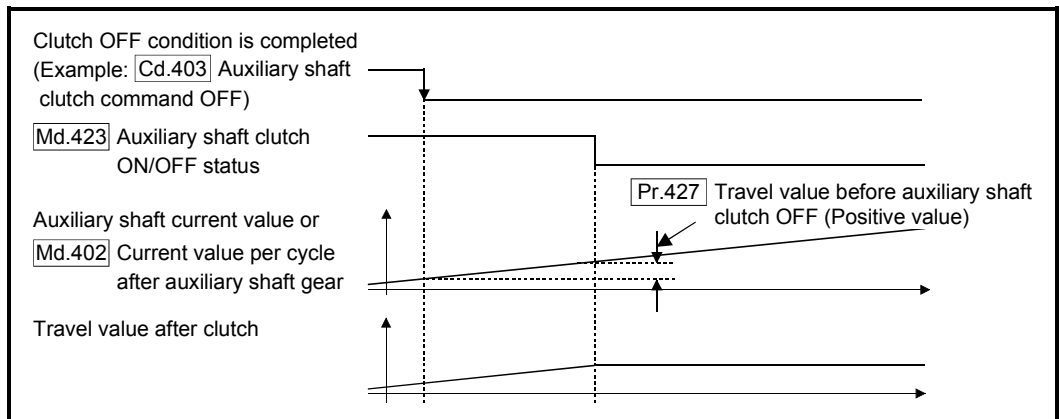

[Pr.428] Auxiliary shaft clutch smoothing method

Set the smoothing method for clutch ON/OFF.

Refer to Section 4.3.3 for details.

- 0: Direct..... No smoothing.
- 1: Time constant method (Exponent) ..... Smoothing with an exponential curve based on the time constant setting.
- 2: Time constant method (Linear)..... Smoothing with linear acceleration/deceleration based on the time constant setting.
- 3: Slippage method (Exponent) ..... Smoothing with an exponential curve based on the slippage amount setting.
- 4: Slippage method (Linear)..... Smoothing with linear acceleration/deceleration based on the slippage amount setting.

[Pr.429] Auxiliary shaft clutch smoothing time constant

Set a time constant when the time constant method is set in "[Pr.428] Auxiliary shaft clutch smoothing method".

The time constant setting applies for clutch ON/OFF.

[Pr.430] Slippage amount at auxiliary shaft clutch ON

Set the slippage amount at clutch ON when the slippage method is set in "[Pr.428] Auxiliary shaft clutch smoothing method".

The slippage amount is set in units based on the current value selected in "[Pr.423] Auxiliary shaft clutch reference address setting".

If the set amount is negative, the slippage amount at clutch ON is controlled as 0 (direct).

[Pr.431] Slippage amount at auxiliary shaft clutch OFF

Set the slippage amount at clutch OFF when the slippage method is set in "[Pr.428] Auxiliary shaft clutch smoothing method".

The slippage amount is set in units based on the current value selected in "[Pr.423] Auxiliary shaft clutch reference address setting".

If the set amount is negative, the slippage amount at clutch OFF is controlled as 0 (direct).

## 4.2.4 Auxiliary shaft clutch control data

Setting item	Setting details	Setting value	Default value	Buffer memory address
[Cd.403] Auxiliary shaft clutch command	• Set the clutch command ON/OFF. <u>Fetch cycle: Operation cycle</u>	■ Set in decimal. 0: Auxiliary shaft clutch command OFF 1: Auxiliary shaft clutch command ON	0	44083+20n
[Cd.404] Auxiliary shaft clutch control invalid command	• Set "1" to disable the clutch control temporarily. <u>Fetch cycle: Operation cycle</u>	■ Set in decimal. 0: Auxiliary shaft clutch control valid 1: Auxiliary shaft clutch control invalid	0	44084+20n
[Cd.405] Auxiliary shaft clutch forced OFF command	• Set "1" to force the clutch OFF. <u>Fetch cycle: Operation cycle</u>	■ Set in decimal. 0: Auxiliary shaft clutch normal control 1: Auxiliary shaft clutch forced OFF	0	44085+20n

n: Axis No.-1

## [Cd.403] Auxiliary shaft clutch command

Use ON/OFF for the auxiliary shaft clutch command. This command is used with the following settings.

- The clutch ON control mode is "1: Clutch command ON/OFF", "2: Clutch command leading edge" or "3: Clutch command trailing edge".
- The clutch OFF control mode is either "2: Clutch command leading edge" or "3: Clutch command trailing edge".

Status is considered as clutch command OFF just before starting synchronous control. If synchronous control is started while the clutch command is ON, the condition is established just after starting synchronous control, by setting "2: Clutch command leading edge". The condition is not established after starting, by setting "3: Clutch command trailing edge".

## [Cd.404] Auxiliary shaft clutch control invalid command

The auxiliary shaft clutch control is invalid if "1" is set. The previous clutch ON/OFF status remains before clutch control becomes invalid.

Clutch control will not become invalid during the movement before clutch ON and clutch OFF. Instead, clutch control will become invalid after the movement is completed.

## [Cd.405] Auxiliary shaft clutch forced OFF command

Set "1" to force the clutch OFF. The output value from the clutch becomes 0 immediately, even during clutch smoothing. The slippage (accumulative) amount is set to 0 if smoothing with a slippage method.

Reset to "0" to restart the clutch control from the clutch OFF status after using the clutch forced OFF command.

### 4.3 Clutch

#### 4.3.1 Overview of clutch

The clutch is used to transmit/disengage command pulses from the main/auxiliary shaft input side to the output axis module through turning the clutch ON/OFF, which controls the operation/stop of the servomotor.

A clutch can be configured for the main and auxiliary shafts.

#### 4.3.2 Control method for clutch

Set the ON and OFF control methods separately in "[Pr.405] Main shaft clutch control setting" and "[Pr.422] Auxiliary shaft clutch control setting".

Although the clutch control setting can be changed during synchronous control, however, the setting "No clutch" (Direct coupled operation) cannot be selected during synchronous control after already selecting another setting.

Item	Setting item		Setting details/Setting value
	Main shaft clutch	Auxiliary shaft clutch	
Clutch control setting	[Pr.405] Main shaft clutch control setting	[Pr.422] Auxiliary shaft clutch control setting	<ul style="list-style-type: none"> <li>• Set the clutch control method.</li> <li>■ Set in hexadecimal.</li> </ul> <div style="margin-left: 20px;"> <p>H</p> <ul style="list-style-type: none"> <li>→ ON control mode                             <ul style="list-style-type: none"> <li>0: No clutch</li> <li>1: Clutch command ON/OFF</li> <li>2: Clutch command leading edge</li> <li>3: Clutch command trailing edge</li> <li>4: Address mode</li> <li>5: High speed input request</li> </ul> </li> <li>→ OFF control mode                             <ul style="list-style-type: none"> <li>0: OFF control invalid</li> <li>1: One-shot OFF</li> <li>2: Clutch command leading edge</li> <li>3: Clutch command trailing edge</li> <li>4: Address mode</li> <li>5: High speed input request</li> </ul> </li> <li>→ High speed input request signal                             <ul style="list-style-type: none"> <li>0 to F: High speed inputrequest signal from axis 1 to axis 16<sup>(Note-1)</sup></li> </ul> </li> </ul> </div>

(Note-1): The range from axis 1 to 2 is valid in the 2-axis module, from axis 1 to 4 is valid in the 4-axis module, from axis 1 to 8 is valid in the 8-axis module, and from axis 1 to 16 is valid in the 16-axis module.

When the clutch ON condition and the clutch OFF condition are completed simultaneously within one operation cycle, both clutch ON and OFF processing are executed within one operation cycle. Therefore, the clutch is from OFF to ON and again to OFF at the clutch OFF status, and it is from ON to OFF and again to ON at the clutch ON status.

The ON and OFF control mode setting for clutch ON/OFF are shown on the next page.

■ ON control mode

(1) No clutch (Direct coupled operation)

Execute direct coupled operation without clutch control.

**POINT**  
 Other clutch parameters are not applicable during direct coupled operation by setting "0: No clutch". "Clutch forced OFF command" and the change of the clutch control setting are ignored during direct coupled operation.

(2) Clutch command ON/OFF

The clutch is turned ON/OFF by the operation of clutch command ON/OFF.  
 (Setting in the OFF control mode are not applicable in this mode.)

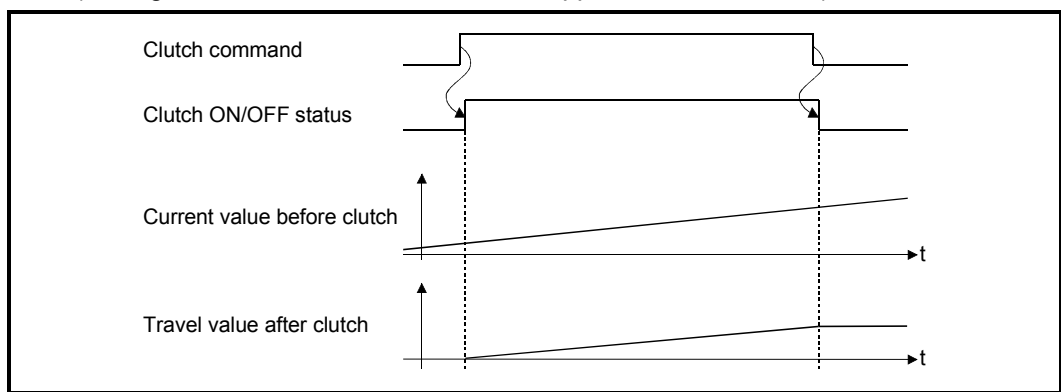

Item	Main shaft clutch	Auxiliary shaft clutch
Clutch command	[Cd.400] Main shaft clutch command	[Cd.403] Auxiliary shaft clutch command
Clutch ON/OFF status	[Md.420] Main shaft clutch ON/OFF status	[Md.423] Auxiliary shaft clutch ON/OFF status

(3) Clutch command leading edge

The clutch is turned ON when the clutch command passes the leading edge (from OFF to ON).

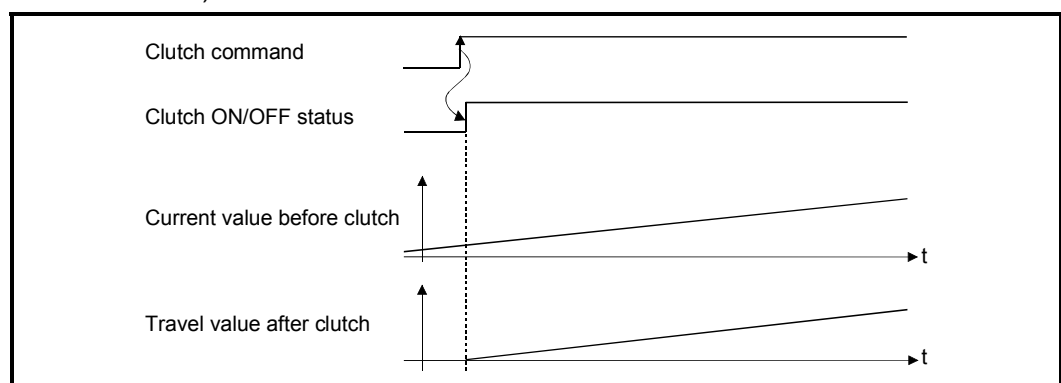

(4) Clutch command trailing edge

The clutch is turned ON when the clutch command passes the trailing edge (from ON to OFF).

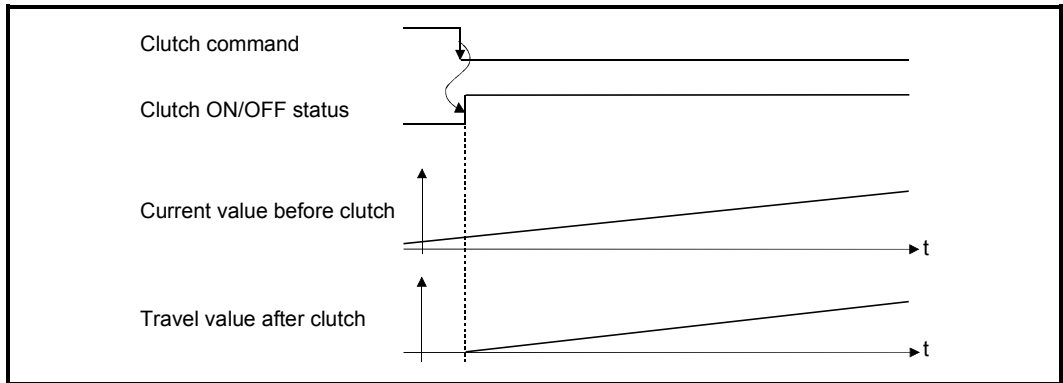

(5) Address mode

The clutch is turned ON when the reference address reaches "Clutch ON address". The travel value after passing through the ON address is calculated as the output travel value of the clutch based on the reference address passing through, thereby controlling the clutch with an accurate travel value.

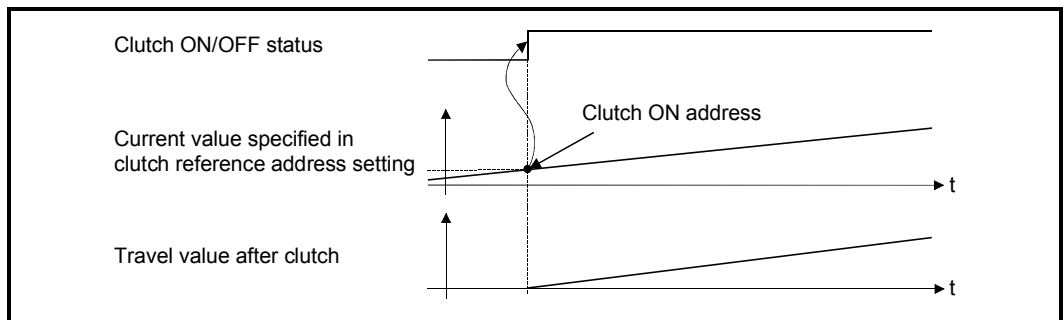

Item	Main shaft clutch	Auxiliary shaft clutch
Reference address	The current value specified in "[Pr.406] Main shaft clutch reference address setting" ("[Md.400] Current value after composite main shaft gear" or "[Md.401] Current value per cycle after main shaft gear")	The current value specified in "[Pr.423] Auxiliary shaft clutch reference address setting" (Auxiliary shaft current value (servo input axis current value/synchronous encoder axis current value) or "[Md.402] Current value per cycle after auxiliary shaft gear")
Clutch ON address	[Pr.407] Main shaft clutch ON address	[Pr.424] Auxiliary shaft clutch ON address
Clutch ON/OFF status	[Md.420] Main shaft clutch ON/OFF status	[Md.423] Auxiliary shaft clutch ON/OFF status



(6) High speed input request

The clutch is turned ON when the high speed input request [DI] turns ON.

The following actions are required when using the high speed input request.

- Set the signal No. for the "High speed input request signal" clutch control setting.
- Set "4: High speed input request" in "[Pr.42] External command function selection" and "1: Validates an external command" in "[Cd.8] External command valid" for the applicable axis.
- For the 16-axis module, set the external command signal in "[Pr.95] External command signal selection" for the applicable axis.

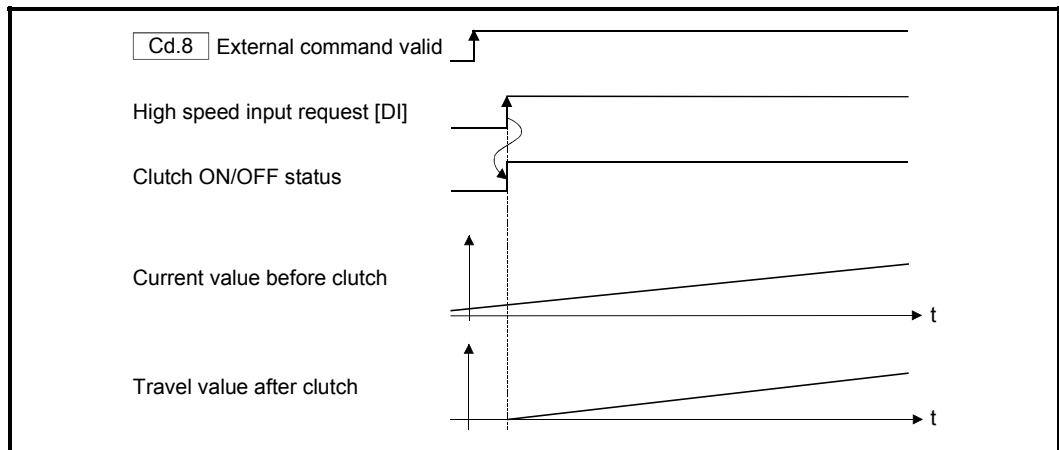

■ OFF control mode

(1) OFF control invalid

Clutch OFF control is not used. This setting is applicable only for execution with clutch ON control.

(2) One-shot OFF

The clutch is turned OFF after moving the distance "Travel value before clutch OFF" (One-shot operation) after the clutch command turn ON.

If "Travel value before clutch OFF" is 0, "Clutch ON/OFF status" does not turn ON in order to turn back OFF immediately.

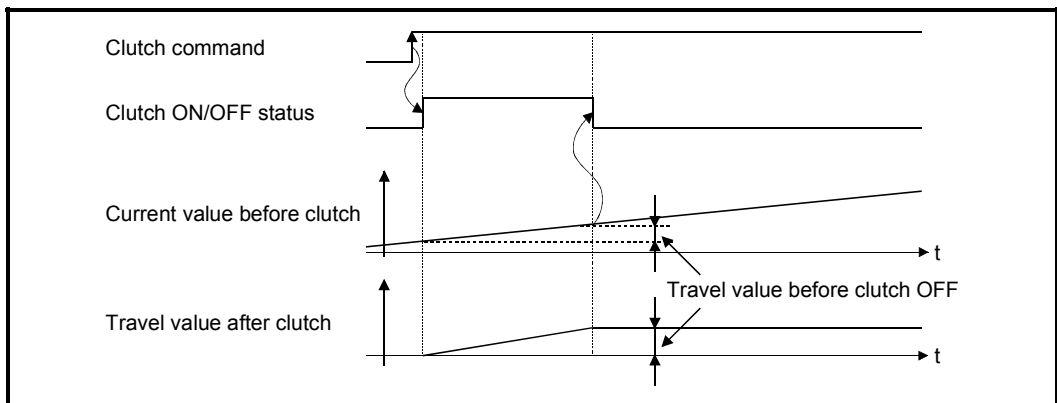

Item	Main shaft clutch	Auxiliary shaft clutch
Clutch command	[Cd.400] Main shaft clutch command	[Cd.403] Auxiliary shaft clutch command
Clutch ON/OFF status	[Md.420] Main shaft clutch ON/OFF status	[Md.423] Auxiliary shaft clutch ON/OFF status
Travel value before clutch OFF	[Pr.410] Travel value before main shaft clutch OFF	[Pr.427] Travel value before auxiliary shaft clutch OFF

(3) Clutch command leading edge

The clutch is turned OFF when the clutch command passes the leading edge (from OFF to ON).

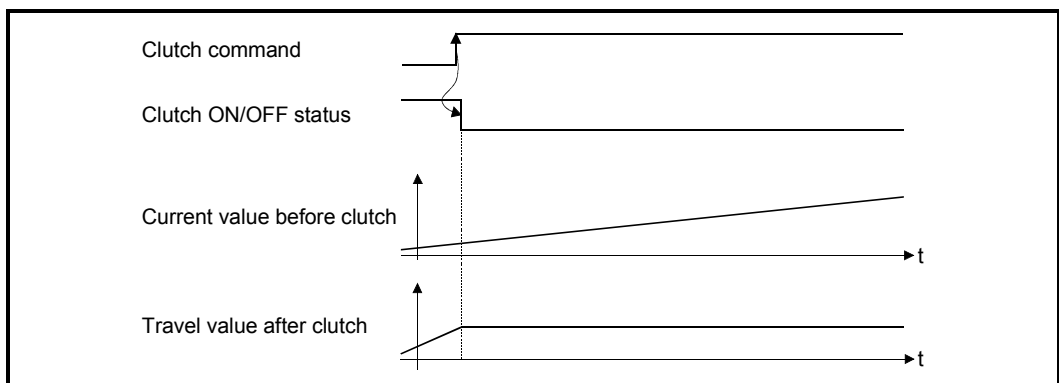

(4) Clutch command trailing edge

The clutch is turned OFF when the clutch command passes the trailing edge (from ON to OFF).

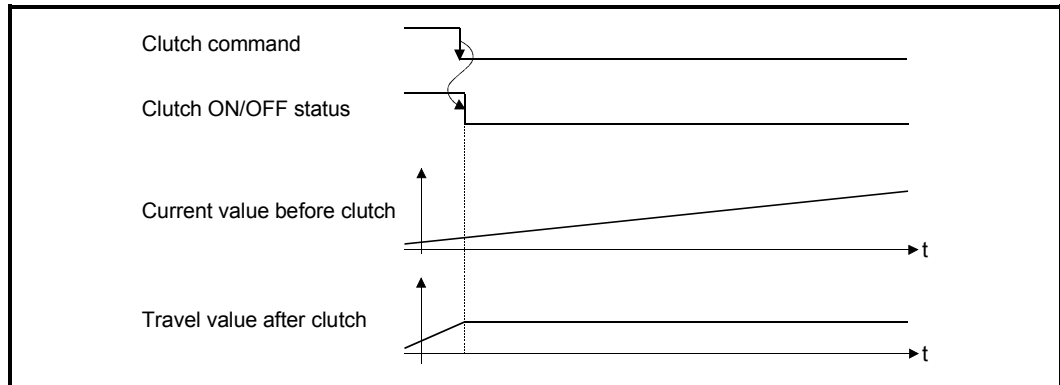

(5) Address mode

The clutch is turned OFF when the reference address reaches "Clutch OFF address". The travel value before passing through the OFF address is calculated as the output travel value of the clutch based on the reference address passing through, thereby controlling the clutch with an accurate travel value.

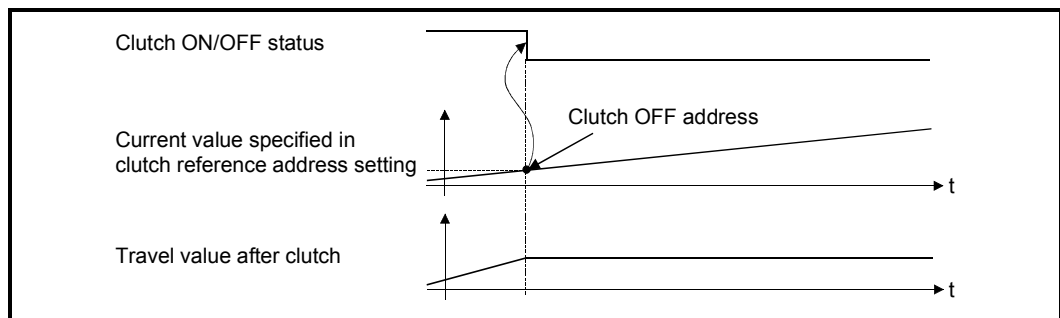

Item	Main shaft clutch	Auxiliary shaft clutch
Reference address	The current value specified in "[Pr.406] Main shaft clutch reference address setting" ("[Md.400] Current value after composite main shaft gear" or "[Md.401] Current value per cycle after main shaft gear")	The current value specified in "[Pr.423] Auxiliary shaft clutch reference address setting" (Auxiliary shaft current value (servo input axis current value/synchronous encoder axis current value) or "[Md.402] Current value per cycle after auxiliary shaft gear")
Clutch OFF address	[Pr.409] Main shaft clutch OFF address	[Pr.426] Auxiliary shaft clutch OFF address
Clutch ON/OFF status	[Md.420] Main shaft clutch ON/OFF status	[Md.423] Auxiliary shaft clutch ON/OFF status

(6) High speed input request

The clutch is turned OFF when the high speed input request [DI] turns ON.

The following actions are required when using the high speed input request.

- Set the signal No. for the "High speed input request" clutch control setting.
- Set "4: High speed input request" in "[Pr.42] External command function selection" and "1: Validates an external command" in "[Cd.8] External command valid" for the applicable axis.
- For the 16-axis module, set the external command signal in "[Pr.95] External command signal selection" for the applicable axis.

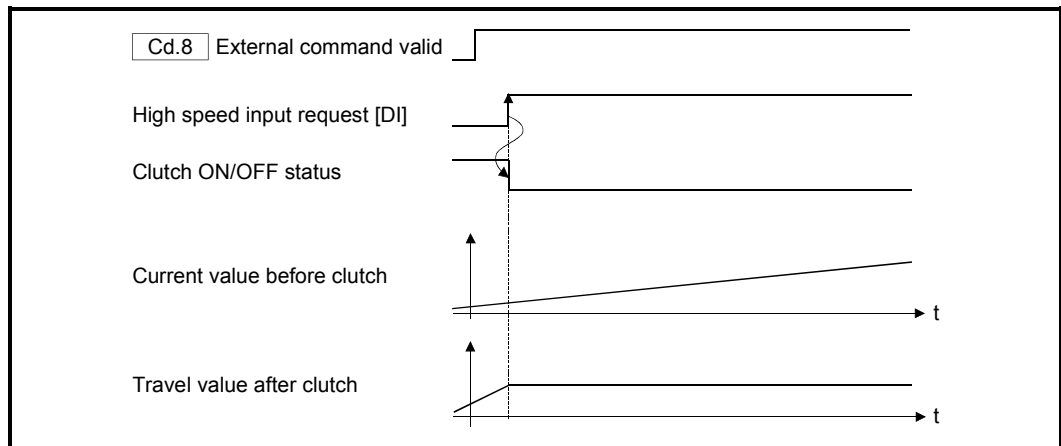

### 4.3.3 Smoothing method for clutch

Set the clutch smoothing method in "[Pr.411] Main shaft clutch smoothing method" and "[Pr.428] Auxiliary shaft clutch smoothing method".

The 2 types of clutch smoothing include the following.

- Time constant method smoothing
- Slippage method smoothing

When not using clutch smoothing, set "0: Direct" in the clutch smoothing method.

Item	Setting item		Setting details/Setting value
	Main shaft clutch	Auxiliary shaft clutch	
Clutch smoothing method	[Pr.411] Main shaft clutch smoothing method	[Pr.428] Auxiliary shaft clutch smoothing method	<ul style="list-style-type: none"> <li>• Set the clutch smoothing method.</li> <li>■ Set in decimal.</li> <li>0: Direct</li> <li>1: Time constant method (Exponent)</li> <li>2: Time constant method (Linear)</li> <li>3: Slippage method (Exponent)</li> <li>4: Slippage method (Linear)</li> </ul>

The operation of each smoothing method is shown below.

#### ■ Time constant method smoothing

Smoothing is processed with the time constant setting value in the smoothing time constant at clutch ON/OFF. After clutch ON smoothing is complete, smoothing is processed with the time constant setting value when the speed of the input values changes.

The travel value between the clutch turning ON and OFF is not changed with smoothing.

Travel value after clutch smoothing = Travel value before clutch smoothing

Item	Setting item		Setting details	Setting value
	Main shaft clutch	Auxiliary shaft clutch		
Clutch smoothing time constant	[Pr.412] Main shaft clutch smoothing time constant	[Pr.429] Auxiliary shaft clutch smoothing time constant	<ul style="list-style-type: none"> <li>• For smoothing with a time constant method, set the smoothing time constant.</li> </ul>	<ul style="list-style-type: none"> <li>■ Set in decimal.</li> <li>0 to 5000 [ms]</li> </ul>

(1) Time constant method exponential curve smoothing

Set "1: Time constant method (Exponential)" in the clutch smoothing method.

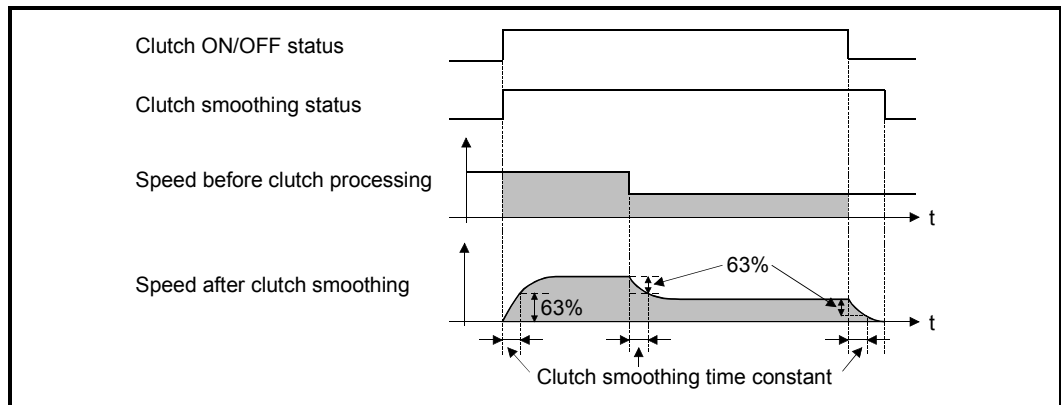

Item	Main shaft clutch	Auxiliary shaft clutch
Clutch ON/OFF status	[Md.420] Main shaft clutch ON/OFF status	[Md.423] Auxiliary shaft clutch ON/OFF status
Clutch smoothing status	[Md.421] Main shaft clutch smoothing status	[Md.424] Auxiliary shaft clutch smoothing status

(2) Time constant method linear acceleration/deceleration smoothing

Set "2: Time constant method (Linear)" in the clutch smoothing method.

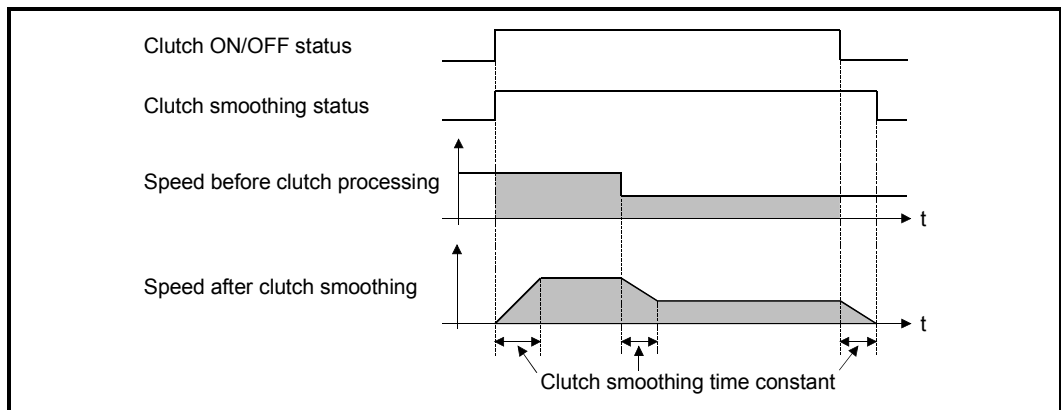

■ Slippage method smoothing

Smoothing is processed with the value in slippage at clutch ON when the clutch turns ON, and with slippage at clutch OFF when the clutch turns OFF.

Smoothing is also processed with the slippage amount setting when the input speed to the clutch changes, therefore, positioning control at clutch ON/OFF is not affected by speed changes.

Processing proceeds with direct operation after completing clutch ON smoothing.

The travel value between the clutch turning ON and OFF is as follows after clutch smoothing.

$$\text{Travel value after clutch smoothing} = \text{Travel value before clutch smoothing} + (\text{Slippage amount at OFF} - \text{Slippage amount at ON})$$

Item	Setting item		Setting details	Setting value
	Main shaft clutch	Auxiliary shaft clutch		
Slippage amount at clutch ON	[Pr.413] Slippage amount at main shaft clutch ON	[Pr.430] Slippage amount at auxiliary shaft clutch ON	• For smoothing with a slippage method, set the slippage amount at clutch ON.	■ Set in decimal. 0 to 2147483647 [Main input axis position units <sup>(Note-1)</sup> /auxiliary shaft position units <sup>(Note-2)</sup> or cam axis cycle units <sup>(Note-3)</sup> ]
Slippage amount at clutch OFF	[Pr.414] Slippage amount at main shaft clutch OFF	[Pr.431] Slippage amount at auxiliary shaft clutch OFF	• For smoothing with a slippage method, set the slippage amount at clutch OFF.	

(Note-1): Main input axis position units (Refer to Chapter 2)

(Note-2): Auxiliary shaft position units (Refer to Chapter 2)

(Note-3): Cam axis cycle units (Refer to Section 4.5.1)

(1) Slippage method exponential curve smoothing

Set "3: Slippage (Exponential)" in the clutch smoothing method.

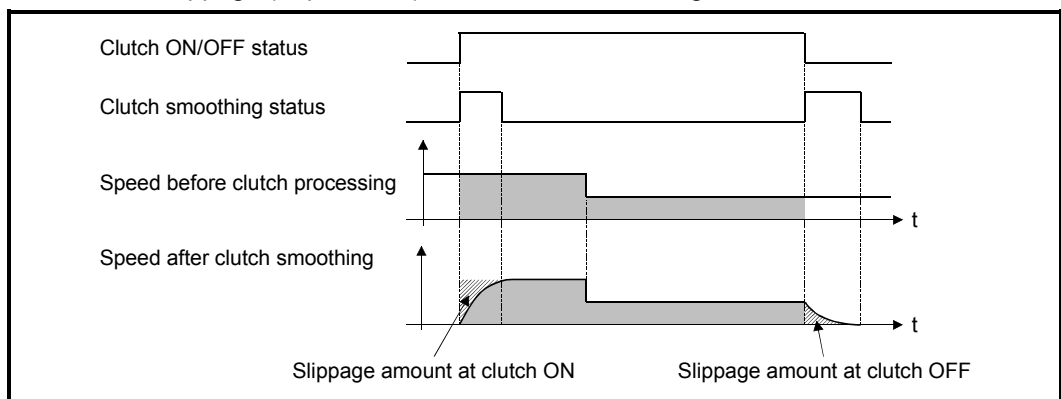

Item	Main shaft clutch	Auxiliary shaft clutch
Clutch ON/OFF status	[Md.420] Main shaft clutch ON/OFF status	[Md.423] Auxiliary shaft clutch ON/OFF status
Clutch smoothing status	[Md.421] Main shaft clutch smoothing status	[Md.424] Auxiliary shaft clutch smoothing status

(2) Slippage method linear acceleration/deceleration smoothing  
 Set "4: Slippage method (Linear)" in the clutch smoothing method.

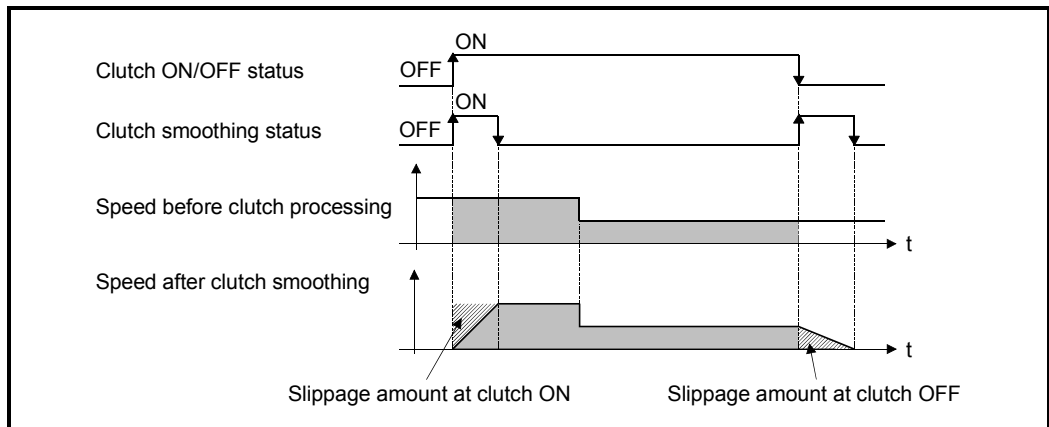

- When the input speed to the clutch is changed continuously and slightly  
 The clutch smoothing status ON section is changed.  
 When the clutch smoothing status ON section is extended

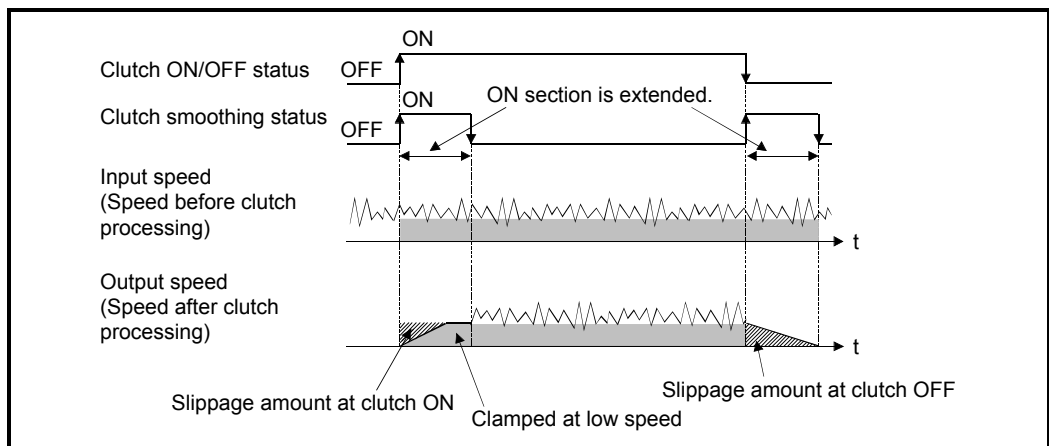

When the clutch smoothing status ON section is shortened

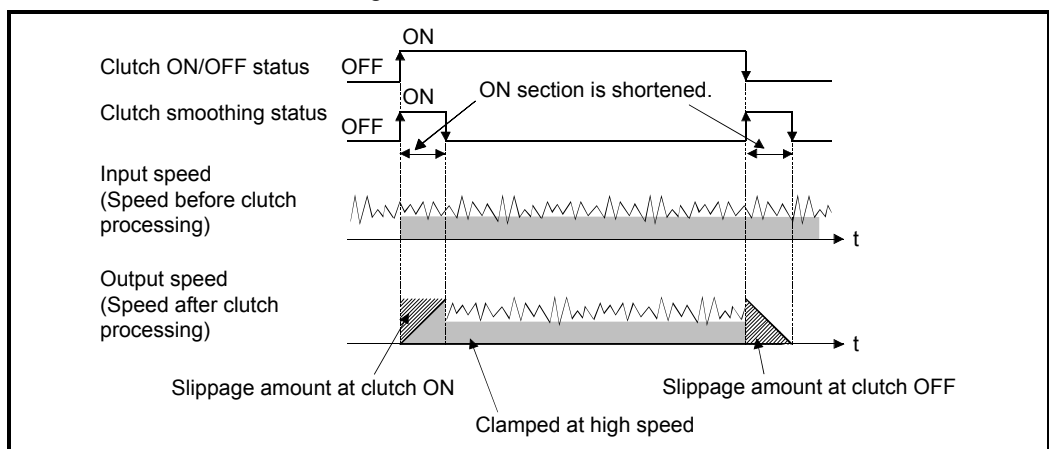



- When the input speed is changed largely during smoothing  
The output speed is changed slightly compared to the change of the input speed.  
(The average speed might be faster than the speed before starting smoothing.)

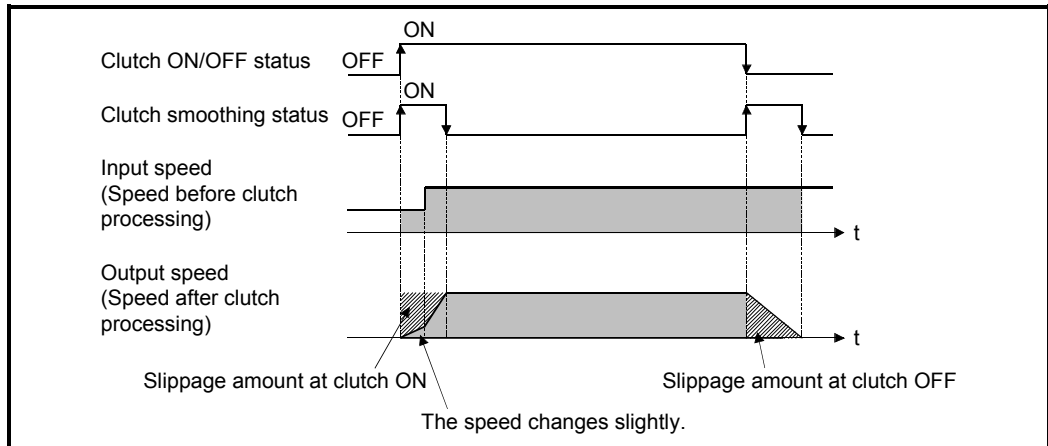

(3) Operation at input speed deceleration during slippage method smoothing

When the speed before clutch processing decreases, the speed after clutch smoothing is controlled without exceeding the speed before clutch processing. If slippage amount remains when the speed before clutch processing becomes 0, the smoothing process will be continued. Then, the clutch smoothing process will be executed with the remaining slippage amount when the speed before clutch processing gets faster than the speed after clutch smoothing.

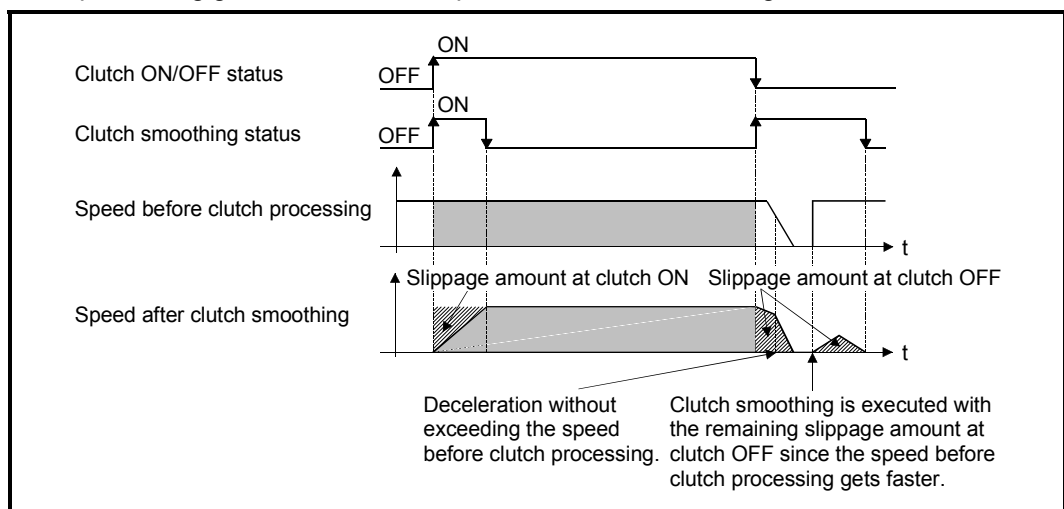

### 4.3.4 Use example of clutch

The following machine shows an example using clutch control for a flying shear cutting system that synchronizes off a start signal from a sensor input.

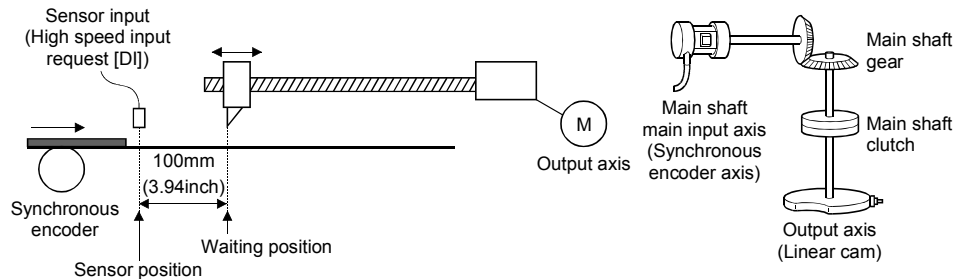

Main shaft clutch setting item		Setting value
[Pr.405] Main shaft clutch control setting	ON control mode	5: High speed input request
	OFF control mode	1: One-shot OFF
	High speed input request signal	(Specify the high speed input request signal No., used for sensor input.)
[Pr.406] Main shaft clutch reference address setting		0: Current value after composite main shaft gear
[Pr.408] Travel value before main shaft clutch ON		0mm
[Pr.410] Travel value before main shaft clutch OFF		380mm (14.96inch)
[Pr.411] Main shaft clutch smoothing method		4: Slippage method (Linear)
[Pr.413] Slippage amount at main shaft clutch ON		100mm (3.94inch) (Distance between the sensor and the waiting position)
[Pr.414] Slippage amount at main shaft clutch OFF		20mm (0.79inch)

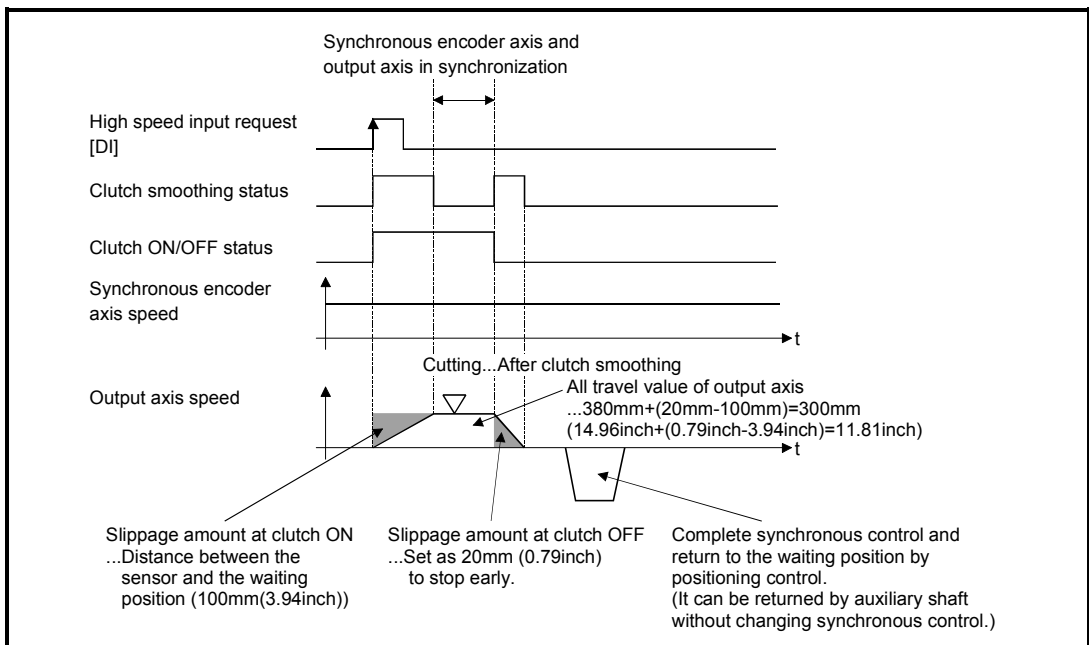

## 4.4 Speed change gear module

### 4.4.1 Overview of speed change gear module

A speed change gear module is used to change the input speed from the main shaft/auxiliary shaft/composite auxiliary shaft gear during operation. When not using a speed change gear module, set "0: No speed change gear" in "[Pr.434] Speed change gear".

With speed change from a speed change gear module, operation is executed with linear acceleration/deceleration based on the setting for the speed change gear smoothing time constant.

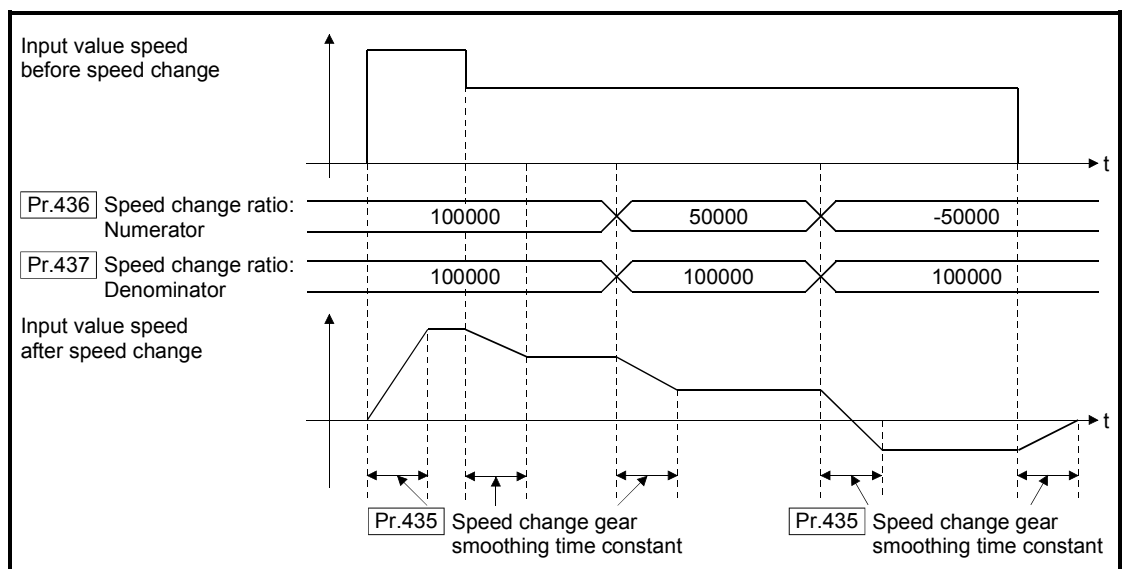
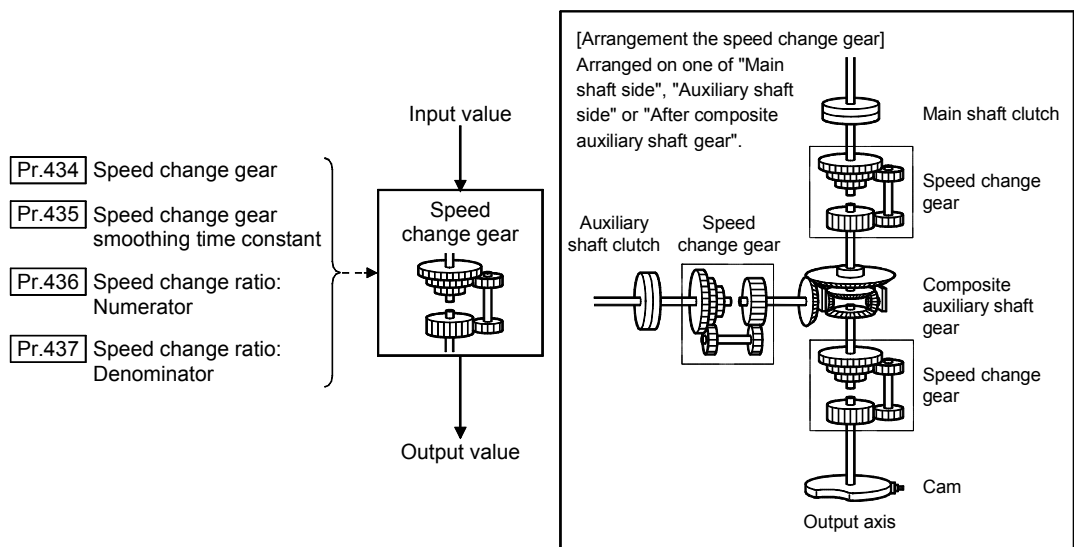

## 4.4.2 Speed change gear parameters

Setting item	Setting details	Setting value	Default value	Buffer memory address
[Pr.434] Speed change gear	<ul style="list-style-type: none"> <li>Set the arrangement for the speed change gear.</li> </ul> Fetch cycle: At start of synchronous control	<ul style="list-style-type: none"> <li>Set in decimal.</li> <li>0: No speed change gear</li> <li>1: Main shaft side</li> <li>2: Auxiliary shaft side</li> <li>3: After composite auxiliary shaft gear</li> </ul>	0	36460+200n
[Pr.435] Speed change gear smoothing time constant	<ul style="list-style-type: none"> <li>Set the smoothing time constant for the speed change gear.</li> </ul> Fetch cycle: At start of synchronous control	<ul style="list-style-type: none"> <li>Set in decimal.</li> <li>0 to 5000 [ms]</li> </ul>	0	36461+200n
[Pr.436] Speed change ratio: Numerator	<ul style="list-style-type: none"> <li>Set the numerator for the speed change ratio.</li> </ul> Fetch cycle: Operation cycle	<ul style="list-style-type: none"> <li>Set in decimal.</li> <li>-2147483648 to 2147483647</li> </ul>	1	36462+200n 36463+200n
[Pr.437] Speed change ratio: Denominator	<ul style="list-style-type: none"> <li>Set the denominator for the speed change ratio.</li> </ul> Fetch cycle: Operation cycle	<ul style="list-style-type: none"> <li>Set in decimal.</li> <li>1 to 2147483647</li> </ul>	1	36464+200n 36465+200n

n: Axis No.-1

## [Pr.434] Speed change gear

Set the arrangement for the speed change gear.

- 0: No speed change gear ..... Speed change is not processed, and the input value is transmitted as is.
- 1: Main shaft side ..... Speed change is processed for input value after main shaft clutch based on the speed change ratio settings.
- 2: Auxiliary shaft side..... Speed change is processed for input value after auxiliary shaft clutch based on the speed change ratio settings.
- 3: After composite auxiliary shaft gear..... Speed change is processed for input value after composite auxiliary shaft gear based on the speed change ratio settings.

## [Pr.435] Speed change gear smoothing time constant

Set the averaging time to execute a smoothing process for the speed change for the speed change gear.

The input response is delayed depending on the time set in the speed change gear smoothing time constant.

Speed is changed directly when "0" is set.

[Pr.436] Speed change ratio: Numerator, [Pr.437] Speed change ratio: Denominator

Set the numerator and the denominator for the speed change ratio.

"[Pr.436] Speed change ratio: Numerator" and "[Pr.437] Speed change ratio: Denominator" can be changed during synchronous control.

Input values for speed change are processed as follows.

$$\text{Input value after change} = \text{Input value before change} \times \frac{\boxed{\text{Pr.436}} \text{ Speed change ratio: Numerator}}{\boxed{\text{Pr.437}} \text{ Speed change ratio: Denominator}}$$

The input speed can be reversed by setting a negative value in "[Pr.436] Speed change ratio: Numerator".

"[Pr.437] Speed change ratio: Denominator" is set within the range from 1 to 2147483647.

## 4.5 Output axis module

### 4.5.1 Overview of output axis module

For the output axis module, the cam axis current value per cycle is calculated based on the input value (the output value from a speed change gear), and is converted based on the set cam data. The feed current value which is a command is output to the servo amplifier.

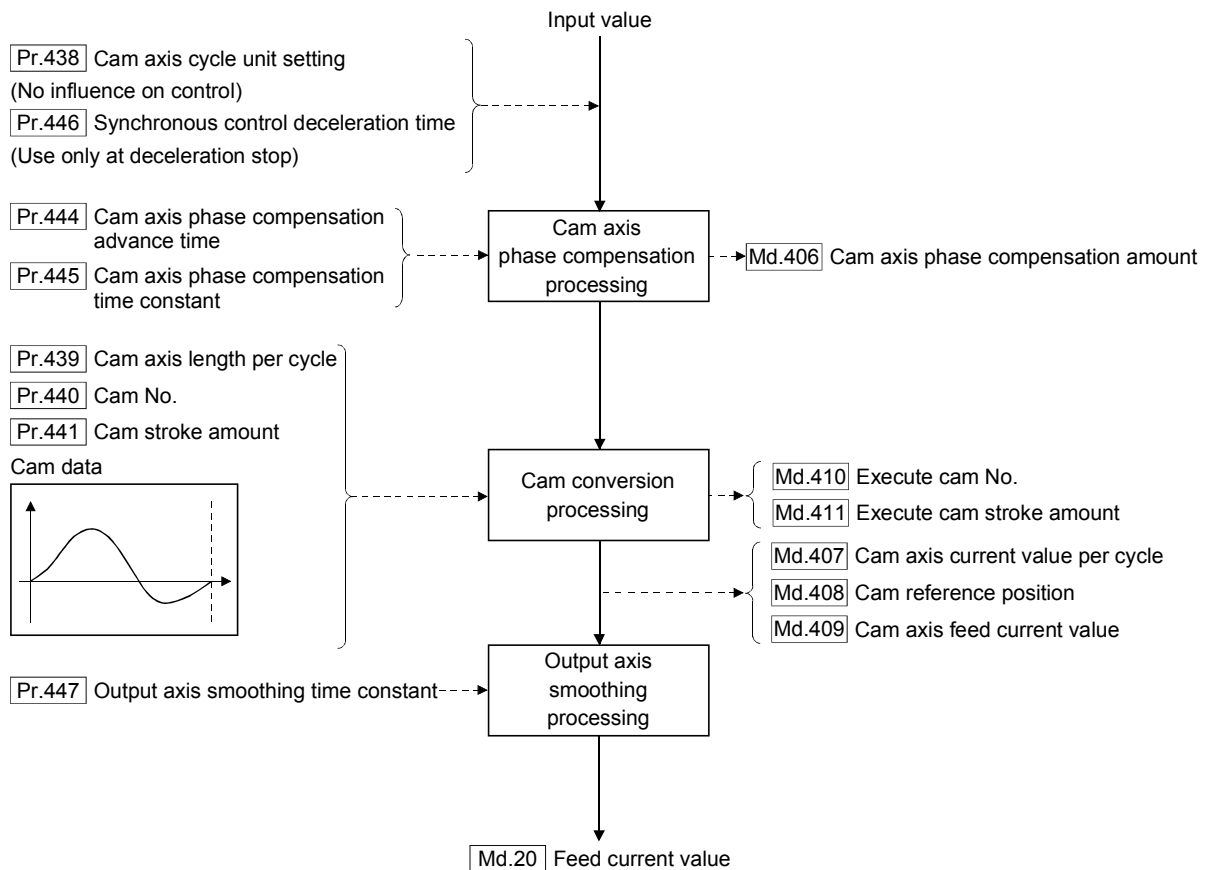

■ Units for the output axis

The position units for the output axis are shown below based on the setting "[Pr.1] Unit setting".

Table 4.1 Output axis position units

Setting value of "[Pr.1] Unit setting"	Output axis position unit	Range
0: mm	$\times 10^{-4}$ mm ( $\times 10^{-1}$ $\mu$ m)	-214748.3648 to 214748.3647 [mm] (-214748364.8 to 214748364.7 [ $\mu$ m])
1: inch	$\times 10^{-5}$ inch	-21474.83648 to 21474.83647 [inch]
2: degree	$\times 10^{-5}$ degree	-21474.83648 to 21474.83647 [degree]
3: PLS	PLS	-2147483648 to 2147483647 [PLS]

Cam axis cycle units are shown below based on the setting "[Pr.438] Cam axis cycle unit setting".

Table 4.2 Cam axis cycle units

Setting value of "[Pr.438] Cam axis cycle unit setting"			Cam axis cycle unit	Range
Unit setting selection	Control unit	Number of decimal places		
0: Use units of main input axis	—	—	Servo input axis position unit (Refer to Section 2.1.1) Synchronous encoder axis position unit (Refer to Section 2.3.1)	
1: Use units of this setting	0: mm	0	mm	-2147483648 to 2147483647 [mm]
		9	$\times 10^{-9}$ mm	-2.147483648 to 2.147483647 [mm]
	1: inch	0	inch	-2147483648 to 2147483647 [inch]
		9	$\times 10^{-9}$ inch	-2.147483648 to 2.147483647 [inch]
	2: degree	0	degree	-2147483648 to 2147483647 [degree]
		9	$\times 10^{-9}$ degree	-2.147483648 to 2.147483647 [degree]
	3: PLS	0	PLS	-2147483648 to 2147483647 [PLS]
		9	$\times 10^{-9}$ PLS	-2.147483648 to 2.147483647 [PLS]

## 4.5.2 Output axis parameters

Setting item	Setting details	Setting value	Default value	Buffer memory address
[Pr.438] Cam axis cycle unit setting	<ul style="list-style-type: none"> <li>Set the units for the cam axis length per cycle.</li> <li>There is no influence on the control for the parameter for monitor display.</li> </ul> Fetch cycle: <u>At start of synchronous control</u>	■ Set in hexadecimal. 	0000h	36470+200n
[Pr.439] Cam axis length per cycle	<ul style="list-style-type: none"> <li>Set the required input amount with the cam per cycle.</li> </ul> Fetch cycle: <u>At start of synchronous control</u>	■ Set in decimal. 1 to 2147483647 [Cam axis cycle units (Note-1)]	QD77MS/ QD77GF/ LD77MS: 4194304 LD77MH: 262144	36472+200n 36473+200n
[Pr.440] Cam No.	<ul style="list-style-type: none"> <li>Set the cam No.</li> </ul> Fetch cycle: <u>At start of synchronous control,</u> <u>At passing through the 0th</u> <u>point of cam data</u>	■ Set in decimal. 0 : Linear cam (Preset) 1 to 256 : User created cam	0	36474+200n
[Pr.441] Cam stroke amount	<ul style="list-style-type: none"> <li>Set the cam stroke amount corresponding to the stroke ratio 100% for cam with stroke ratio data format.</li> <li>This is ignored for cams using the coordinate data format.</li> </ul> Fetch cycle: <u>At start of synchronous control,</u> <u>At passing through the 0th</u> <u>point of cam data</u>	■ Set in decimal. -2147483648 to 2147483647 [Output axis position units (Note-2)]	QD77MS/ QD77GF/ LD77MS: 4194304 LD77MH: 262144	36476+200n 36477+200n
[Pr.444] Cam axis phase compensation advance time	<ul style="list-style-type: none"> <li>Set the time to advance or delay the phase of the cam axis.</li> </ul> Fetch cycle: <u>Operation cycle</u>	■ Set in decimal. -2147483648 to 2147483647 [μs]	0	36482+200n 36483+200n
[Pr.445] Cam axis phase compensation time constant	<ul style="list-style-type: none"> <li>Set the time constant to affect the phase compensation of the cam axis.</li> </ul> Fetch cycle: <u>At start of synchronous control</u>	■ Set in decimal. 0 to 65535 [ms] (Note-3)	10	36484+200n
[Pr.446] Synchronous control deceleration time	<ul style="list-style-type: none"> <li>Set the deceleration time for the synchronous control.</li> </ul> Fetch cycle: <u>At start of synchronous control</u>	■ Set in decimal. 0 to 65535 [ms] (Note-3)	0	36485+200n
[Pr.447] Output axis smoothing time constant	<ul style="list-style-type: none"> <li>Set to smooth the output axis.</li> </ul> Fetch cycle: <u>At start of synchronous control</u>	■ Set in decimal. 0 to 5000 [ms]	0	36486+200n

n: Axis No.-1

(Note-1): Cam axis cycle units (Refer to Section 4.5.1)

(Note-2): Output axis position units (Refer to Section 4.5.1)

(Note-3): Set the value as follows in a program.

0 to 32767 ..... Set as a decimal

32768 to 65535 ..... Convert into a hexadecimal and set



[Pr.438] Cam axis cycle unit setting

Set the command units for the cam axis input per cycle to be used for cam control. These units are used for setting the cam axis length per cycle and the cam axis current value per cycle. There is no influence on the control for the parameter for monitor display. Refer to Section 4.5.1 for details.

[Pr.439] Cam axis length per cycle

Set the length per cycle of the cam axis to generate the cam axis current value per cycle. The unit settings are in the cam axis cycle units (Refer to Section 4.5.1). Set a value within the range from 1 to 2147483647.

[Pr.440] Cam No.

Set the cam No. for cam control. Cam No.0 operates as a linear cam for 100% of its stroke ratio along the cam axis length per cycle. The cam No. can be changed during synchronous control. The value set in "[Pr.440] Cam No." is valid when the cam axis current value per cycle passes through the 0th point of cam data, or is on the 0th point.

[Pr.441] Cam stroke amount

Set the cam stroke amount corresponding to a 100% stroke ratio in output axis position units (Refer to Section 4.5.1) for cam control using the stroke ratio data format. The cam stroke amount can be changed during synchronous control. The value set in "[Pr.441] Cam stroke amount" is valid when the cam axis current value per cycle passes through the 0th point of cam data, or is on the 0th point. The setting value is ignored for a cam using the coordinate data format.

[Pr.444] Cam axis phase compensation advance time

Set the time to advance or delay the phase of the cam axis current value per cycle in the cam control.  
1 to 2147483647 [ $\mu$ s]..... Advance the phase according to the setting time.  
0 [ $\mu$ s] ..... Do not execute phase compensation.  
-2147483648 to -1 [ $\mu$ s] ..... Delay the phase according to the setting time.  
If the setting time is too long, the system experiences overshoot or undershoot at acceleration/deceleration of the input speed. In this case, set a longer time to affect the phase compensation amount in "[Pr.445] Cam axis phase compensation time constant".

[Pr.445] Cam axis phase compensation time constant

Set the time constant to affect the phase compensation amount for the first order delay.  
63 [%] of the phase compensation amount is reflected in the time constant setting.

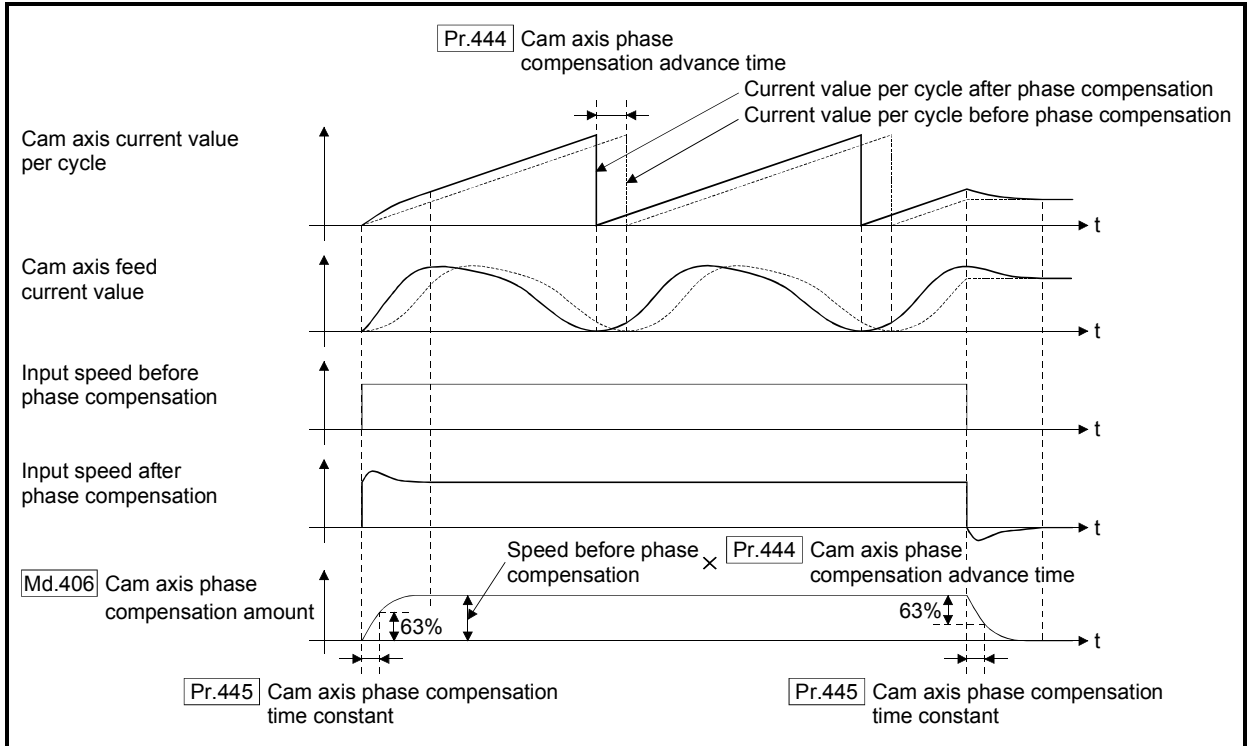

[Pr.446] Synchronous control deceleration time

Set the time to decelerate to a stop when deceleration stop occurs during synchronous control.

Set the time from "[Pr.8] Speed limit value" until the speed becomes 0 in units of ms.  
Operation assumes an immediate stop when "0" is set.

[Pr.447] Output axis smoothing time constant

Set the averaging time to execute a smoothing process for the travel value of the output axis after cam data conversion.

The smoothing process can moderate rapid speed fluctuation for cams using the coordinate data format, etc.

The input response is delayed depending on the time corresponding to the setting by smoothing process setting.

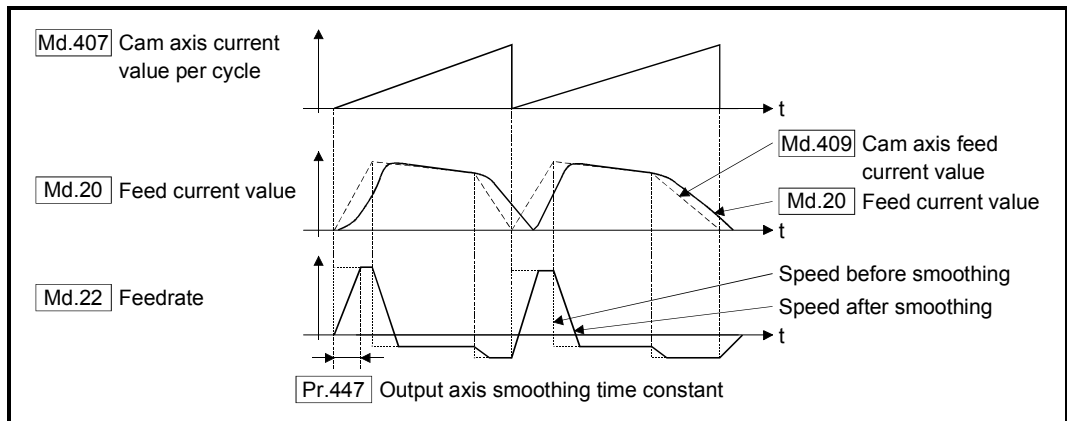

## 4.6 Synchronous control change function

### 4.6.1 Overview of synchronous control change function

This function can change the cam reference position, the cam axis current value per cycle and the current value per cycle after the main/auxiliary shaft gear during the synchronous control.

The following 5 methods exist for the synchronous control change function.

Refer to Section 4.6.2 for details on each change command.

Synchronous control change command	Application	Output axis operation
Cam reference position movement	Adjust the cam reference position by travel value.	Operated
Change cam axis current value per cycle	Change the cam axis current value per cycle.	None
Change current value per cycle after main shaft gear	Change the current value per cycle after main shaft gear.	None
Change current value per cycle after auxiliary shaft gear	Change the current value per cycle after auxiliary shaft gear.	None
Cam axis current value per cycle movement	Adjust the phase of the cam axis by travel value.	Operated

## 4.6.2 Synchronous control change control data

Setting item	Setting details	Setting value	Default value	Buffer memory address
[Cd.406] Synchronous control change request	<ul style="list-style-type: none"> <li>Set "1" to initiate a synchronous control change command request. The value is reset to "0" automatically after completion of the synchronous control change.</li> </ul> <u>Fetch cycle: Operation cycle</u>	<ul style="list-style-type: none"> <li>Set in decimal.</li> <li>1: Synchronous control change request</li> </ul>	0	44086+20n
[Cd.407] Synchronous control change command	<ul style="list-style-type: none"> <li>Set the synchronous control change command.</li> </ul> <u>Fetch cycle: At requesting synchronous control change</u>	<ul style="list-style-type: none"> <li>Set in decimal.</li> <li>0: Cam reference position movement</li> <li>1: Change cam axis current value per cycle</li> <li>2: Change current value per cycle after main shaft gear</li> <li>3: Change current value per cycle after auxiliary shaft gear</li> <li>4: Cam axis current value per cycle movement</li> </ul>	0	44087+20n
[Cd.408] Synchronous control change value	<ul style="list-style-type: none"> <li>Set the change value for synchronous control change processing.</li> </ul> <u>Fetch cycle: At requesting synchronous control change</u>	<ul style="list-style-type: none"> <li>Set in decimal.</li> <li>-2147483648 to 2147483647</li> <li>(Refer to the detailed explanation on the next page for units.)</li> </ul>	0	44088+20n 44089+20n
[Cd.409] Synchronous control reflection time	<ul style="list-style-type: none"> <li>Set the reflection time for synchronous control change processing.</li> </ul> <u>Fetch cycle: At requesting synchronous control change</u>	<ul style="list-style-type: none"> <li>Set in decimal.</li> <li>0 to 65535 [ms] (Note-1)</li> </ul>	0	44090+20n

n: Axis No.-1

(Note-1): Set the value as follows in a program.

0 to 32767 ..... Set as a decimal.

32768 to 65535 ..... Convert into a hexadecimal and set.

[Cd.406] Synchronous control change request

Set "1" to initiate "[Cd.407] Synchronous control change command". The Simple Motion module resets the value to "0" automatically after completion of the synchronous control change.

The setting is initialized to "0" when starting synchronous control.

[Cd.407] Synchronous control change command

Set the synchronous control change command.

- 0: Cam reference position movement..... (1)
- 1: Change cam axis current value per cycle ..... (2)
- 2: Change current value per cycle after main shaft gear ..... (3)
- 3: Change current value per cycle after auxiliary shaft gear ..... (4)
- 4: Cam axis current value per cycle movement ..... (5)

(1) Cam reference position movement

This command is executed to move the cam reference position through adding the setting travel value of "[Cd.408] Synchronous control change value". The travel value to be added is averaged in "[Cd.409] Synchronous control reflection time" for its output.

Set a long reflection time when a large travel value is used since the cam axis feed current value moves with the travel value.

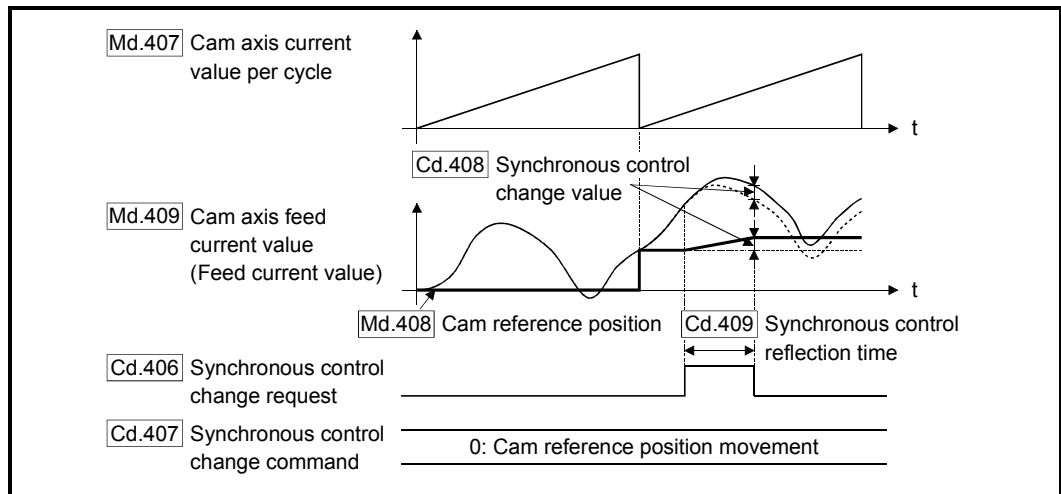

When "[Cd.406] Synchronous control change request" is reset to "0" while executing the cam reference position movement command, operation is stopped midway. If the cam reference position movement command is executed again, the remainder travel value is not reflected, and the operation starts with "[Cd.408] Synchronous control change value" to be used again.

If synchronous control is stopped while the cam reference position movement command is being executed, operation also stops midway. If synchronous control is restarted, the remainder travel value is not reflected.

(2) Change cam axis current value per cycle

The cam axis current value per cycle is changed to "[Cd.408] Synchronous control change value". The cam reference position will be also changed to correspond to the changed cam axis current value per cycle.

This operation is completed within one operation cycle.

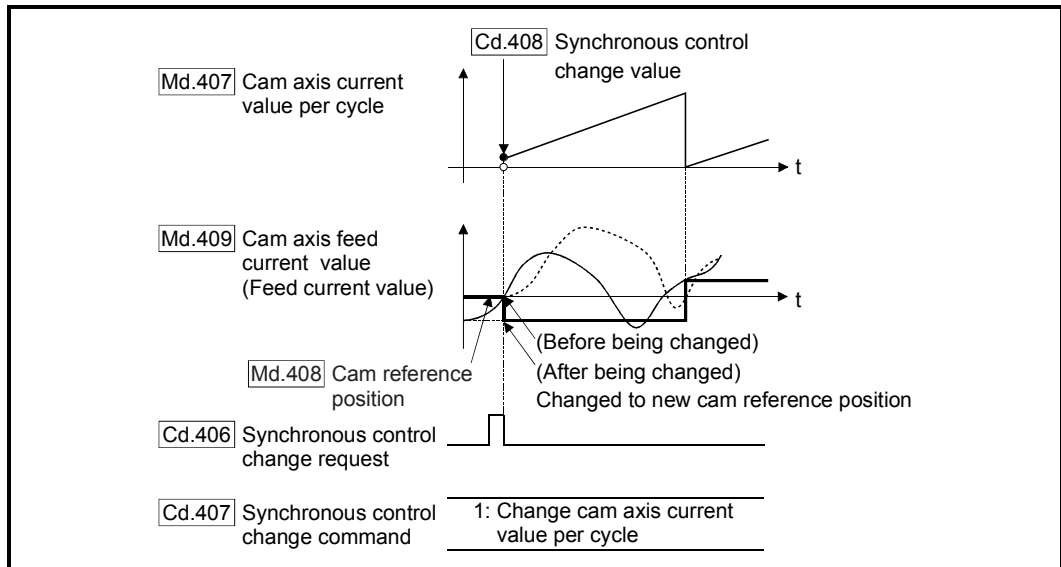

(3) Change current value per cycle after main shaft gear

The current value per cycle after main shaft gear is changed to the value set in "[Cd.408] Synchronous control change value".

This operation is completed within one operation cycle.

Clutch control is not executed if the current value per cycle after main shaft gear (the value before being changed and after being changed) has already passed through the ON/OFF address in address mode.

(4) Change current value per cycle after auxiliary shaft gear

The current value per cycle after auxiliary shaft gear is changed to the value set in "[Cd.408] Synchronous control change value".

This operation is completed within one operation cycle.

Clutch control is not executed if the current value per cycle after the auxiliary shaft gear (the value before being changed and after being changed) has already passed through the ON/OFF address in address mode.

(5) Cam axis current value per cycle movement

This command is executed to move the cam axis current value per cycle through adding the setting travel value of "[Cd.408] Synchronous control change value". The travel value to be added is averaged in "[Cd.409] Synchronous control reflection time" for its output.

Set a long reflection time when a large travel value is used since the cam axis feed current value moves with the travel value.

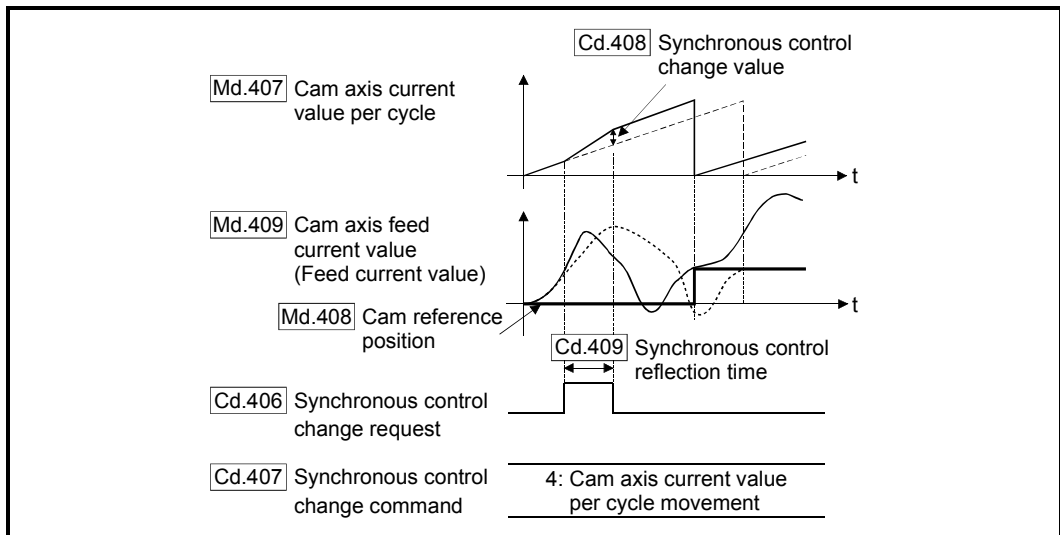

[Cd.408] Synchronous control change value

Set the change value for synchronous control change processing as follows.

[Cd.407] Synchronous control change command	[Cd.408] Synchronous control change value		
	Setting range	Unit	Setting details
0: Cam reference position movement	-2147483648 to 2147483647	Output axis position unit	Set the travel value of the cam reference position. It moves within the range from -2147483648 to 2147483647.
1: Change cam axis current value per cycle		Cam axis cycle unit	Set the change current value per cycle. The setting value is converted within the range from 0 to (Cam axis length per cycle- 1).
2: Change current value per cycle after main shaft gear			
3: Change current value per cycle after auxiliary shaft gear			
4: Cam axis current value per cycle movement			Set the travel value of the cam axis current value per cycle. It moves within the range from -2147483648 to 2147483647.



## [Cd.409] Synchronous control reflection time

Set the reflection time for synchronous control change processing as follows.

[Cd.407] Synchronous control change command	Setting details for "[Cd.409] Synchronous control reflection time"
0: Cam reference position movement	The time to reflect the travel value to the cam reference position.
1: Change cam axis current value per cycle	Setting not required.
2: Change current value per cycle after main shaft gear	
3: Change current value per cycle after auxiliary shaft gear	
4: Cam axis current value per cycle movement	The time to reflect the travel value to the cam axis current value per cycle.

## 4.7 Synchronous control monitor data

Synchronous control monitor data is updated only during synchronous control.

The monitor values ([Md.400], [Md.401], [Md.402], [Md.407], [Md.408], and [Md.409]) from the last synchronous control session are restored the next time the system's power supply turns ON. Restarting operation status from the last synchronous control session is possible through returning to the last position via positioning control (Refer to Chapter 5).

"The last synchronous control session" indicates status just before the last synchronous control session was stopped as follows. These are listed with the last synchronization status.

- Just before "[Cd.380] Synchronous control start" turns from ON to OFF.
- Just before deceleration stop by a stop command or an error, etc.
- Just before the system's power supply turned OFF to the Simple Motion module.

Monitor item	Storage details	Monitor value	Buffer memory address
[Md.400] Current value after composite main shaft gear	<ul style="list-style-type: none"> <li>• The current value after combining the main input and sub input values from the main shaft is stored.</li> <li>• Value is stored even after system's power supply OFF.</li> </ul> <u>Refresh cycle: Operation cycle (During synchronous control only)</u>	<ul style="list-style-type: none"> <li>■ Monitoring is carried out in decimal display.</li> <li>-2147483648 to 2147483647</li> <li>[Main input axis position units <sup>(Note-1)</sup>]</li> </ul>	42800+40n 42801+40n
[Md.401] Current value per cycle after main shaft gear	<ul style="list-style-type: none"> <li>• The current value per cycle after the main shaft gear is stored.</li> <li>• One cycle is considered the cam axis length per cycle.</li> <li>• Value is stored even after system's power supply OFF.</li> </ul> <u>Refresh cycle: Operation cycle (During synchronous control only)</u>	<ul style="list-style-type: none"> <li>■ Monitoring is carried out in decimal display.</li> <li>0 to (Cam axis length per cycle-1)</li> <li>[Cam axis cycle units <sup>(Note-2)</sup>]</li> </ul>	42802+40n 42803+40n
[Md.402] Current value per cycle after auxiliary shaft gear	<ul style="list-style-type: none"> <li>• The current value per cycle after the auxiliary shaft gear is stored.</li> <li>• One cycle is considered the cam axis length per cycle.</li> <li>• Value is stored even after system's power supply OFF.</li> </ul> <u>Refresh cycle: Operation cycle (During synchronous control only)</u>	<ul style="list-style-type: none"> <li>■ Monitoring is carried out in decimal display.</li> <li>0 to (Cam axis length per cycle-1)</li> <li>[Cam axis cycle units <sup>(Note-2)</sup>]</li> </ul>	42804+40n 42805+40n
[Md.406] Cam axis phase compensation amount	<ul style="list-style-type: none"> <li>• The current phase compensation amount is stored.</li> </ul> <u>Refresh cycle: Operation cycle (During synchronous control only)</u>	<ul style="list-style-type: none"> <li>■ Monitoring is carried out in decimal display.</li> <li>-2147483648 to 2147483647</li> <li>[Cam axis cycle units <sup>(Note-2)</sup>]</li> </ul>	42810+40n 42811+40n
[Md.407] Cam axis current value per cycle	<ul style="list-style-type: none"> <li>• The current value per cycle is stored, which is calculated from the input travel value to the cam axis. (The value after phase compensation)</li> <li>• Value is stored even after system's power supply OFF.</li> </ul> <u>Refresh cycle: Operation cycle (During synchronous control only)</u>	<ul style="list-style-type: none"> <li>■ Monitoring is carried out in decimal display.</li> <li>0 to (Cam axis length per cycle-1)</li> <li>[Cam axis cycle units <sup>(Note-2)</sup>]</li> </ul>	42812+40n 42813+40n

n: Axis No.-1

(Note-1): Main input axis position units (Refer to Chapter 2)

(Note-2): Cam axis cycle units (Refer to Section 4.5.1)

Monitor item	Storage details	Monitor value	Buffer memory address
[Md.408] Cam reference position	<ul style="list-style-type: none"> <li>The feed current value as the cam reference position is stored.</li> <li>Value is stored even after system's power supply OFF.</li> </ul> <u>Refresh cycle: Operation cycle (During synchronous control only)</u>	<ul style="list-style-type: none"> <li>Monitoring is carried out in decimal display.</li> <li>-2147483648 to 2147483647</li> <li>[Output axis position units <sup>(Note-3)</sup>]</li> </ul>	42814+40n 42815+40n
[Md.409] Cam axis feed current value	<ul style="list-style-type: none"> <li>The feed current value while controlling the cam axis is stored.</li> <li>Value is stored even after system's power supply OFF.</li> </ul> <u>Refresh cycle: Operation cycle (During synchronous control only)</u>	<ul style="list-style-type: none"> <li>Monitoring is carried out in decimal display.</li> <li>-2147483648 to 2147483647</li> <li>[Output axis position units <sup>(Note-3)</sup>]</li> </ul>	42816+40n 42817+40n
[Md.410] Execute cam No.	<ul style="list-style-type: none"> <li>The executing cam No. is stored.</li> </ul> <u>Refresh cycle: Operation cycle (During synchronous control only)</u>	<ul style="list-style-type: none"> <li>Monitoring is carried out in decimal display.</li> <li>0 to 256</li> </ul>	42818+40n
[Md.411] Execute cam stroke amount	<ul style="list-style-type: none"> <li>The executing cam stroke amount is stored.</li> </ul> <u>Refresh cycle: Operation cycle (During synchronous control only)</u>	<ul style="list-style-type: none"> <li>Monitoring is carried out in decimal display.</li> <li>-2147483648 to 2147483647</li> <li>[Output axis position units <sup>(Note-3)</sup>]</li> </ul>	42820+40n 42821+40n
[Md.420] Main shaft clutch ON/OFF status	<ul style="list-style-type: none"> <li>The ON/OFF status of main shaft clutch is stored.</li> </ul> <u>Refresh cycle: Operation cycle (During synchronous control only)</u>	<ul style="list-style-type: none"> <li>Monitoring is carried out in decimal display.</li> <li>0: Clutch OFF status</li> <li>1: Clutch ON status</li> </ul>	42828+40n
[Md.421] Main shaft clutch smoothing status	<ul style="list-style-type: none"> <li>The smoothing status of main shaft clutch is stored.</li> </ul> <u>Refresh cycle: Operation cycle (During synchronous control only)</u>	<ul style="list-style-type: none"> <li>Monitoring is carried out in decimal display.</li> <li>0: Not on clutch smoothing</li> <li>1: On clutch smoothing</li> </ul>	42829+40n
[Md.422] Main shaft clutch slippage (accumulative)	<ul style="list-style-type: none"> <li>The accumulative slippage of the main shaft clutch smoothing with slippage method is stored as a signed value.</li> </ul> <u>Refresh cycle: Operation cycle (During synchronous control only)</u>	<ul style="list-style-type: none"> <li>Monitoring is carried out in decimal display.</li> <li>-2147483648 to 2147483647</li> <li>[Main input axis position units <sup>(Note-1)</sup> or Cam axis cycle units <sup>(Note-2)</sup>]</li> </ul>	42830+40n 42831+40n
[Md.423] Auxiliary shaft clutch ON/OFF status	<ul style="list-style-type: none"> <li>The ON/OFF status of the auxiliary shaft clutch is stored.</li> </ul> <u>Refresh cycle: Operation cycle (During synchronous control only)</u>	<ul style="list-style-type: none"> <li>Monitoring is carried out in decimal display.</li> <li>0: Clutch OFF status</li> <li>1: Clutch ON status</li> </ul>	42832+40n
[Md.424] Auxiliary shaft clutch smoothing status	<ul style="list-style-type: none"> <li>The smoothing status of the auxiliary shaft clutch is stored.</li> </ul> <u>Refresh cycle: Operation cycle (During synchronous control only)</u>	<ul style="list-style-type: none"> <li>Monitoring is carried out in decimal display.</li> <li>0: Not on clutch smoothing</li> <li>1: On clutch smoothing</li> </ul>	42833+40n
[Md.425] Auxiliary shaft clutch slippage (accumulative)	<ul style="list-style-type: none"> <li>The accumulative slippage on the auxiliary shaft clutch smoothing with slippage method is stored as a signed value.</li> </ul> <u>Refresh cycle: Operation cycle (During synchronous control only)</u>	<ul style="list-style-type: none"> <li>Monitoring is carried out in decimal display.</li> <li>-2147483648 to 2147483647</li> <li>[Auxiliary shaft position units <sup>(Note-4)</sup> or Cam axis cycle units <sup>(Note-2)</sup>]</li> </ul>	42834+40n 42835+40n

n: Axis No.-1

(Note-1): Main input axis position units (Refer to Chapter 2)

(Note-2): Cam axis cycle units (Refer to Section 4.5.1)

(Note-3): Output axis position units (Refer to Section 4.5.1)

(Note-4): Auxiliary shaft position units (Refer to Chapter 2)

[Md.400] Current value after composite main shaft gear

The current value after combining the main input and the sub input values going into the composite main shaft gear is stored as an accumulative value. Units are in position units of the main input axis (Refer to Chapter 2). The unit is PLS if the main input axis is invalid. The current value after composite main shaft gear will be changed when the following operations are executed in the main input axis during synchronous control.

Operations of main input axis (Synchronous control)	Servo input axis		Command generation axis	Synchronous encoder axis
	Absolute position detection system: valid	Absolute position detection system: invalid		
HPR	Change method 1)		—	—
Current value change	Change method 1)		Change method 1)	Change method 1)
Speed control (Note-1)	Change method 1)		Change method 1)	—
Fixed-feed control	Change method 1)		—	—
Speed-position switching control (Note-1)	Change method 1)		Change method 1)	—
Position-speed switching control (Note-1)	Change method 1)		—	—
Connection to servo amplifier	Change method 2)	Change method 1)	—	—
Connection to synchronous encoder	—		—	Change method 1)

(Note-1): When "2: Clear feed current value to zero" is set in "[Pr.21] Feed current value during speed control" only.

Change method 1): The new current value after composite main shaft gear is calculated based on the current value of the main input axis.

$$\text{Current value after composite main shaft gear} = \text{Main input direction of composite main shaft gear} \times \text{Main input axis current value}$$

Change method 2): The travel value of the main input axis from the last synchronous control session is reflected to the current value after composite main shaft gear.

$$\text{Current value after composite main shaft gear} = \text{Current value after composite main shaft gear} + \text{Main input direction of composite main shaft gear} \times \text{Travel value of main input axis from the last synchronous control session}$$

[Md.401] Current value per cycle after main shaft gear

The input travel value after the main shaft gear is stored within the range from 0 to (Cam axis length per cycle - 1). The unit is in cam axis cycle units (Refer to Section 4.5.1).

The value is restored according to "[Pr.460] Setting method of current value per cycle after main shaft gear" when starting synchronous control. (Refer to Section 5.1)

[Md.402] Current value per cycle after auxiliary shaft gear

The input travel value after the auxiliary shaft gear is stored within the range from 0 to (Cam axis length per cycle - 1). The unit is in cam axis cycle units (Refer to Section 4.5.1).

The value is restored according to "[Pr.461] Setting method of current value per cycle after auxiliary shaft gear" when starting synchronous control. (Refer to Section 5.1)

[Md.406] Cam axis phase compensation amount

The phase compensation amount for the cam axis is stored with cam axis cycle units (Refer to Section 4.5.1).

The phase compensation amount after smoothing processing with "[Pr.445] Cam axis phase compensation time constant" is stored.

[Md.407] Cam axis current value per cycle

The cam axis current value per cycle is stored within the range from 0 to (Cam axis length per cycle - 1).

The current value after cam axis phase compensation processing can be monitored. The unit is in cam axis cycle units (Refer to Section 4.5.1).

The value is restored according to "[Pr.462] Cam axis position restoration object" when starting synchronous control. (Refer to Section 5.1)

[Md.408] Cam reference position

The feed current value is stored as the cam reference position. The unit is in output axis position units (Refer to Section 4.5.1). When the unit is in degrees, a range from 0 to 35999999 is used.

The value is restored according to "[Pr.462] Cam axis position restoration object" when starting synchronous control. (Refer to Section 5.1)

[Md.409] Cam axis feed current value

The feed current value of the cam axis is stored. The value is the same as "[Md.20] Feed current value" during synchronous control.

[Md.410] Execute cam No.

The executing cam No. is stored.

When "[Pr.440] Cam No." is changed during synchronous control, this is updated when the controlling cam No. switches.

[Md.411] Execute cam stroke amount

The executing cam stroke amount is stored.

When "[Pr.441] Cam stroke amount" is changed during synchronous control, this is updated when the controlling cam stroke amount switches.

[Md.420] Main shaft clutch ON/OFF status,

[Md.423] Auxiliary shaft clutch ON/OFF status

The clutch ON/OFF status is stored.

[Md.421] Main shaft clutch smoothing status,

[Md.424] Auxiliary shaft clutch smoothing status

The smoothing status of the clutch is stored. The status is updated by the clutch smoothing method as follows.

Time constant method.....The status is always "1: On clutch smoothing" during the clutch ON status.

The status will be "0: Not on clutch smoothing" when the clutch is turned OFF and smoothing is completed.

Slippage method.....The status is "1: On clutch smoothing" till the clutch accumulative slippage amount reaches the slippage at clutch ON when the clutch is turned ON. The status will change to "0: Not on clutch smoothing" when the clutch accumulative slippage amount reaches the slippage at clutch ON.

The status is "1: On clutch smoothing" till the clutch accumulative slippage amount reaches 0 when the clutch is turned OFF. The status will change to "0: Not on clutch smoothing" when the clutch accumulative slippage amount reaches 0.

[Md.422] Main shaft clutch slippage (accumulative),

[Md.425] Auxiliary shaft clutch slippage (accumulative)

The accumulative slippage amount with the slippage method is stored as a signed value.

The absolute value of the accumulative slippage increases to reach the slippage at clutch ON during clutch ON.

The absolute value of the accumulative slippage decreases to reach 0 during clutch OFF.

Monitoring of the accumulative slippage is used to check the smoothing progress with the slippage method.

## 4.8 Phase compensation function

In synchronous control, delays in progresses, etc. cause the phase to deviate at the output axis motor shaft end with respect to the input axis (servo input axis or synchronous encoder axis). The phase compensation function compensates in this case so that the phase does not deviate.

Phase compensation can be set for the input and the output axis. It is possible to compensate using the delay time peculiar to the system based on the servo input axis or the synchronous encoder axis on the input axis side. It is also possible to use a compensation delay time equivalent to the position deviation for each servo amplifier on the output axis side.

### ■ Phase compensation of delay time of the input axis

Set delay time peculiar to the system in the phase compensation advance time of the input axis ("[Pr.302] Servo input axis phase compensation advance time", "[Pr.326] Synchronous encoder axis phase compensation advance time").

The delay time peculiar to the system is shown below.

#### (1) Delay time peculiar to the system for a servo input axis

##### (a) QD77MS

Operation cycle [ms]	[Pr.300] Servo input axis type			
	Feed current value	Real current value	Command to servo amplifier	Feedback value
0.88	0 [μs]	1833 [μs]	0 [μs]	3611 [μs]
1.77	0 [μs]	1833 [μs]	0 [μs]	5389 [μs]

##### (b) QD77GF [RJ010 mode]

Operation cycle [ms]	[Pr.300] Servo input axis type			
	Feed current value	Real current value	Command to servo amplifier	Feedback value
0.88	0 [μs]	1774 [μs]	0 [μs]	3763 [μs]
1.77	0 [μs]	3482 [μs]	0 [μs]	7251 [μs]
3.55	0 [μs]	7002 [μs]	0 [μs]	14397 [μs]

##### (c) QD77GF [CiA402 mode]

Operation cycle [ms]	[Pr.300] Servo input axis type			
	Feed current value	Real current value	Command to servo amplifier	Feedback value
1.00	0 [μs]	2777 [μs]	0 [μs]	4777 [μs]
2.00	0 [μs]	4722 [μs]	0 [μs]	8722 [μs]
4.00	0 [μs]	8722 [μs]	0 [μs]	16722 [μs]

##### (d) LD77MS

Operation cycle [ms]	[Pr.300] Servo input axis type			
	Feed current value	Real current value	Command to servo amplifier	Feedback value
0.88	0 [μs]	1781 [μs]	0 [μs]	3672 [μs]
1.77	0 [μs]	1776 [μs]	0 [μs]	5443 [μs]

##### (e) LD77MH

Operation cycle [ms]	[Pr.300] Servo input axis type			
	Feed current value	Real current value	Command to servo amplifier	Feedback value
0.88	0 [μs]	1778 [μs]	0 [μs]	3556 [μs]
1.77	0 [μs]	1778 [μs]	0 [μs]	5333 [μs]

## (2) Delay time peculiar to the system for a synchronous encoder axis

## (a) QD77MS

Operation cycle [ms]	[Pr.320] Synchronous encoder axis type		
	Incremental synchronous encoder	Synchronous encoder via servo amplifier	Synchronous encoder via CPU
0.88	2287 [ $\mu$ s]	3634 [ $\mu$ s]	2287 + Scan time [ $\mu$ s]
1.77	3953 [ $\mu$ s]	5413 [ $\mu$ s]	3953 + Scan time [ $\mu$ s]

## (b) QD77GF [RJ010 mode]

Operation cycle [ms]	[Pr.320] Synchronous encoder axis type	
	Incremental synchronous encoder	Synchronous encoder via CPU
0.88	2387 [ $\mu$ s]	2387 + Scan time [ $\mu$ s]
1.77	4968 [ $\mu$ s]	4968 + Scan time [ $\mu$ s]
3.55	10236 [ $\mu$ s]	10236 + Scan time [ $\mu$ s]

## (c) QD77GF [CiA402 mode]

Operation cycle [ms]	[Pr.320] Synchronous encoder axis type		
	Incremental synchronous encoder	Synchronous encoder via servo amplifier	Synchronous encoder via CPU
1.00	2819 [ $\mu$ s]	4822 [ $\mu$ s]	2819 + Scan time [ $\mu$ s]
2.00	5814 [ $\mu$ s]	8767 [ $\mu$ s]	5814 + Scan time [ $\mu$ s]
4.00	11814 [ $\mu$ s]	16768 [ $\mu$ s]	11814 + Scan time [ $\mu$ s]

## (d) LD77MS

Operation cycle [ms]	[Pr.320] Synchronous encoder axis type		
	Incremental synchronous encoder	Synchronous encoder via servo amplifier	Synchronous encoder via CPU
0.88	2398 [ $\mu$ s]	3634 [ $\mu$ s]	2398 + Scan time [ $\mu$ s]
1.77	4045 [ $\mu$ s]	5413 [ $\mu$ s]	4045 + Scan time [ $\mu$ s]

## (e) LD77MH

Operation cycle [ms]	[Pr.320] Synchronous encoder axis type	
	Incremental synchronous encoder	Synchronous encoder via CPU
0.88	2256 [ $\mu$ s]	2256 + Scan time [ $\mu$ s]
1.77	4036 [ $\mu$ s]	4036 + Scan time [ $\mu$ s]



### ■ Phase compensation of delay time of the output axis

Set delay time equivalent to the position deviation on the servo amplifier in "[Pr.444] Cam axis phase compensation advance time" for the output axis. The delay time equivalent to position deviation of the servo amplifier is calculated using the following formula. (MR-J3(W)-B, MR-J4(W)-B, MR-J4-GF, and MR-JE-B(F) use)

$$\text{Delay time } [\mu\text{s}] = \frac{1000000}{\text{Servo parameter "Model loop gain"(PB07)}}$$

(Note): When the feed forward gain is set, the delay time is set to a smaller value than the value listed above.

The model loop gain will change when the gain adjustment method is auto tuning mode 1 or 2. The model loop gain must not be changed on the axis executing phase compensation through preventing change with the manual mode or interpolation mode setting.

### ■ Setting example

When axis 1 is synchronized with an incremental synchronous encoder axis, the phase compensation advance time is set as follows.

(If the operation cycle is as 1.77 [ms] and model loop gain of axis 1 is as 80.)

Setting item	Setting value
[Pr.326] Synchronous encoder axis phase compensation advance time	QD77MS : 3953 [ $\mu\text{s}$ ] QD77GF : 4968 [ $\mu\text{s}$ ] LD77MS : 4045 [ $\mu\text{s}$ ] LD77MH : 4036 [ $\mu\text{s}$ ] (Reference: Delay time peculiar to system for a synchronous encoder axis)
[Pr.444] Cam axis phase compensation advance time	$\frac{1000000}{80} = 12500$ [ $\mu\text{s}$ ]

When overshoot or undershoot occurs during acceleration/deceleration, set a longer time for the phase compensation time constant.

## 4.9 Output axis sub functions

The following shows which sub functions apply for the output axis in synchronous control.

Sub function	Output axis	Details
Backlash compensation function	○	The same control as other methods.
Electronic gear function	○	
Speed limit function	—	Setting is ignored. ("[Pr.8] Speed limit value" must be set to use "[Pr.446] Synchronous control deceleration time".)
Torque limit function	○	Controlled with "[Pr.17] Torque limit setting value" or "[Cd.101] Torque output setting value" similar to other methods.
Software stroke limit function	○	The axis stops immediately when exceeding the software stroke limit range. To disable the software stroke limit, set the setting value so that "Upper limit value = Lower limit value".
Hardware stroke limit function	○	Controlled the same as positioning control.
Forced stop function	○	Same control as other methods.
Speed change function	—	Setting is ignored.
Override function	—	
Acceleration/deceleration time change function	—	
Torque change function	○	Same control as other methods.
Absolute position system	○	
Step function	—	Setting is ignored.
Skip function	—	
M code output function	—	M code is not able to output.
Teaching function	○	Same control as other methods.
Target position change function	—	Setting is ignored.
Command in-position function	—	
Acceleration/deceleration processing function	○	Valid at deceleration stop only. Deceleration time is set in "[Pr.446] Synchronous control deceleration time".
Pre-reading start function	—	Setting is ignored.
Deceleration start flag function	—	
Stop command processing for deceleration stop function	—	
Speed control 10 x multiplier setting for degree axis function	○	Reflected on monitor data.

○: Valid, —: Invalid

Sub function	Output axis	Details
Operation setting for incompleteness of HPR function	○	Controlled the same as positioning control. For a system that needs alignment, start synchronous control after establishing an HP.
Servo ON/OFF	○	Servo OFF request is ignored during synchronous control similar to positioning control.

○: Valid, —: Invalid

POINT
<p>Sub functions for an input axis in synchronous control conform to the specification of each control (HPR control, Positioning control, Manual control, Speed torque control).</p> <p>Refer to the "User's Manual (Positioning control)" of each Simple Motion module for details.</p> <p>The delay time inherent to the system of a command generation axis is 0, so that the phase compensation function does not exist.</p>



# Chapter 5 Synchronous Control Initial Position

The initial position for synchronous control is explained in this chapter.

Configure these settings for situations that require initial position alignment for synchronous control.

- 5.1 Synchronous control initial position.....5- 2
- 5.2 Synchronous control initial position parameters .....5- 7
- 5.3 Cam axis position restoration method.....5-11
  - 5.3.1 Cam axis current value per cycle restoration.....5-11
  - 5.3.2 Cam reference position restoration.....5-17
  - 5.3.3 Cam axis feed current value restoration .....5-19
- 5.4 Synchronous control analysis mode .....5-22
- 5.5 Cam position calculation function .....5-24
  - 5.5.1 Cam position calculation control data .....5-25
  - 5.5.2 Cam position calculation monitor data .....5-27
- 5.6 Method to restart synchronous control.....5-33

### 5.1 Synchronous control initial position

The following synchronous control monitor data can be aligned to a set position when starting synchronous control, as the initial position for synchronous control.

The alignment to a synchronous control initial position is useful for restoring a system based on the last control status along with restarting synchronous control after canceling midway.

Synchronous control monitor data	The position when starting synchronous control
[Md.400] Current value after composite main shaft gear	Restored to a position based on the main input axis of the main shaft.
[Md.401] Current value per cycle after main shaft gear	Restored according to "[Pr.460] Setting method of current value per cycle after main shaft gear".
[Md.402] Current value per cycle after auxiliary shaft gear	Restored according to "[Pr.461] Setting method of current value per cycle after auxiliary shaft gear".
[Md.407] Cam axis current value per cycle	Restored according to "[Pr.462] Cam axis position restoration object".
[Md.408] Cam reference position	
[Md.409] Cam axis feed current value	

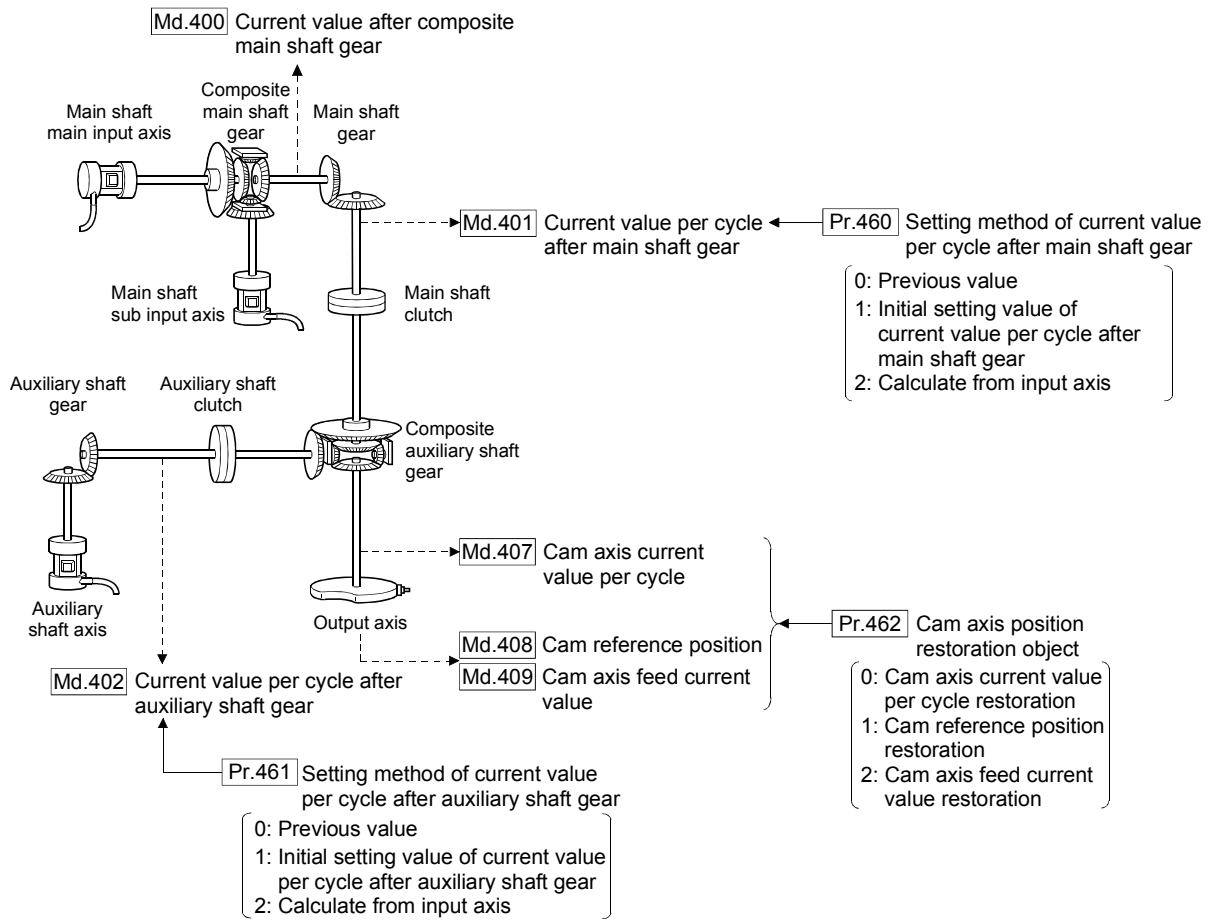

- Current value after composite main shaft gear when starting synchronous control  
The current value after composite main shaft gear is restored as follows according to the main input axis operation executed before starting synchronous control.

Operation of main input axis (Before synchronous control start)	Servo input axis		Command generation axis	Synchronous encoder axis
	Absolute position detection system valid	Absolute position detection system invalid		
HPR	Restoration method 1)		—	—
Current value change	Restoration method 1)		Restoration method 1)	Restoration method 1)
Speed control (Note-1)	Restoration method 1)		Restoration method 1)	—
Fixed-feed control	Restoration method 1)		—	—
Speed-position switching control (Note-1)	Restoration method 1)		Restoration method 1)	—
Position-speed switching control (Note-1)	Restoration method 1)		—	—
Connection to servo amplifier	Restoration method 2)	Restoration method 1)	—	—
Connection to synchronous encoder	—		—	Restoration method 1)
Others	Restoration method 2)		Restoration method 2)	Restoration method 2)

(Note-1): When "[Pr.300] Servo input axis type" is either "1: Feed current value" or "2: Real current value", and when "[Pr.21] Feed current value during speed control" is "2: Clear feed current value to zero" only.

Restoration method 1): The new current value after composite main shaft gear is calculated based on the current value of the main input axis.

$$\text{Current value after composite main shaft gear} = \text{Main input direction of composite main shaft gear} \times \text{Main input axis current value}$$

Restoration method 2): The travel value of the main input axis from the last synchronous control session is reflected to the current value after composite main shaft gear.

$$\text{Current value after composite main shaft gear} = \text{Current value after composite main shaft gear at the last synchronous control session} + \text{Main input direction of composite main shaft gear} \times \text{Amount of change of main input axis current value from the last synchronous control session}$$

The current value after composite main shaft gear at the last synchronous control session is restored when "0: Invalid" is set in "[Pr.400] Main input axis No.", or when a servo input axis or a synchronous encoder axis as the main input axis is not connected.

**REMARK**

"The last synchronous control session" indicates status just before the last synchronous control session was stopped as follows. These are listed with the last synchronization status.

- Just before "[Cd.380] Synchronous control start" turns from ON to OFF.
- Just before deceleration stop by a stop command or an error, etc.
- Just before the system's power supply turned OFF to the Simple Motion module.

■ **Current value per cycle after main shaft gear, current value per cycle after auxiliary shaft gear when starting synchronous control**

The current value per cycle after main shaft gear/current value per cycle after auxiliary shaft gear is restored as follows according to the main input axis/auxiliary shaft operation executed before starting synchronous control.

Operation of main input axis / auxiliary shaft (Before synchronous control start)	Servo input axis		Command generation axis	Synchronous encoder axis
	Absolute position detection system valid	Absolute position detection system invalid		
HPR	Restoration method 1)		—	—
Current value change	Restoration method 1)		Restoration method 1)	Restoration method 1)
Speed control (Note-1)	Restoration method 1)		Restoration method 1)	—
Fixed-feed control	Restoration method 1)		—	—
Speed-position switching control (Note-1)	Restoration method 1)		Restoration method 1)	—
Position-speed switching control (Note-1)	Restoration method 1)		—	—
Connection to servo amplifier	Restoration method 2)	Restoration method 1)	—	—
Connection to synchronous encoder	—		—	Restoration method 1)
Others	Restoration method 2)		Restoration method 2)	Restoration method 2)

(Note-1): When "[Pr.300] Servo input axis type" is either "1: Feed current value" or "2: Real current value", and when "[Pr.21] Feed current value during speed control" is "2: Clear feed current value to zero" only.

Restoration method 1): The new value of the current value per cycle after main shaft gear/current value per cycle after auxiliary shaft gear is calculated based on the current value after composite main shaft gear/auxiliary shaft current value.

[Main shaft]

$$\text{Current value per cycle after main shaft gear} = \text{Main shaft gear ratio} \times \text{Current value after composite main shaft gear}$$

[Auxiliary shaft]

$$\text{Current value per cycle after auxiliary shaft gear} = \text{Auxiliary shaft gear ratio} \times \text{Auxiliary shaft current value}$$



Restoration method 2): The travel value from the last synchronous control session is reflected to the current value per cycle after main shaft gear/current value per cycle after auxiliary shaft gear.

[Main shaft]

$$\begin{array}{l} \text{Current value per} \\ \text{cycle after main} \\ \text{shaft gear} \end{array} = \begin{array}{l} \text{Current value per cycle} \\ \text{after main shaft gear at} \\ \text{the last synchronous} \\ \text{control session} \end{array} + \begin{array}{l} \text{Main shaft} \\ \text{gear ratio} \end{array} \times \begin{array}{l} \text{Amount of change of current} \\ \text{value after composite main} \\ \text{shaft gear from the last} \\ \text{synchronous control session} \end{array}$$

[Auxiliary shaft]

$$\begin{array}{l} \text{Current value per} \\ \text{cycle after} \\ \text{auxiliary shaft} \\ \text{gear} \end{array} = \begin{array}{l} \text{Current value per cycle} \\ \text{after auxiliary shaft gear} \\ \text{at the last synchronous} \\ \text{control session} \end{array} + \begin{array}{l} \text{Auxiliary} \\ \text{shaft} \\ \text{gear ratio} \end{array} \times \begin{array}{l} \text{Amount of change of auxiliary} \\ \text{shaft current value from the} \\ \text{last synchronous control} \\ \text{session} \end{array}$$

The current value per cycle after main shaft gear/current value per cycle after auxiliary shaft gear at the last synchronous control session is restored when "0: Invalid" is set in "[Pr.400] Main input axis No."/[Pr.418] Auxiliary shaft axis No.", or when a servo input axis or a synchronous encoder axis as the main input axis/auxiliary shaft is not connected.

■ Cam axis position at synchronous control start

The cam axis position is composed of the relationship of 3 positions "Cam axis current value per cycle", "Cam reference position" and "Cam axis feed current value". One of positions can be restored by defining 2 positions when starting synchronous control.

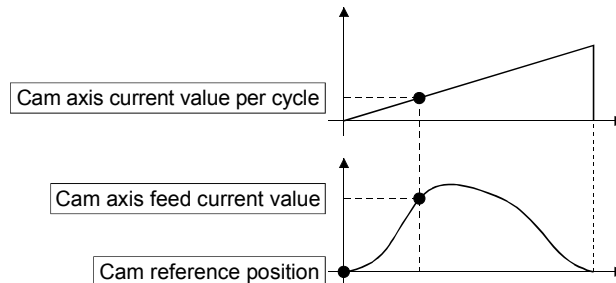

Select from 3 objects as follows in "[Pr.462] Cam axis position restoration object" which position is to be restored.

(Refer to Section 5.3 for details on the restoration method.)

- [1] Cam axis current value per cycle restoration
- [2] Cam reference position restoration
- [3] Cam axis feed current value restoration

Various parameters need to be set for the cam axis position restoration as shown in Table 5.1. (Refer to Section 5.2 for the setting details.)

Table 5.1 Setting list for cam axis position restoration parameters

[Pr.462] Cam axis position restoration object	[Pr.463] Setting method of cam reference position	[Pr.467] Cam reference position (Initial setting)	[Pr.464] Setting method of cam axis current value per cycle	[Pr.468] Cam axis current value per cycle (Initial setting)	Restoration processing details
0: Cam axis current value per cycle restoration	○	△	—	○ (Used as search starting point)	Restore "Cam axis current value per cycle" based on "Cam reference position" and "Cam axis feed current value".
1: Cam reference position restoration	—	—	○	△	Restore "Cam reference position" based on "Cam axis current value per cycle" and "Cam axis feed current value".
2: Cam axis feed current value restoration	○	△	○	△	Restore "Cam axis feed current value" based on "Cam axis current value per cycle" and "Cam reference position".

○: Required, △:Required for initial setting value, —: Not required

## 5.2 Synchronous control initial position parameters

Setting item	Setting details	Setting value	Default value	Buffer memory address
[Pr.460] Setting method of current value per cycle after main shaft gear	<ul style="list-style-type: none"> <li>Select the setting method for the current value per cycle after main shaft gear.</li> </ul> <u>Fetch cycle: At start of synchronous control</u>	<ul style="list-style-type: none"> <li>Set in decimal.</li> <li>0: Previous value</li> <li>1: Initial setting value of current value per cycle after main shaft gear ([Pr.465])</li> <li>2: Calculate from input axis</li> </ul>	0	36500+200n
[Pr.461] Setting method of current value per cycle after auxiliary shaft gear	<ul style="list-style-type: none"> <li>Select the setting method for the current value per cycle after auxiliary shaft gear.</li> </ul> <u>Fetch cycle: At start of synchronous control</u>	<ul style="list-style-type: none"> <li>Set in decimal.</li> <li>0: Previous value</li> <li>1: Initial setting value of current value per cycle after auxiliary shaft gear ([Pr.466])</li> <li>2: Calculate from input axis</li> </ul>	0	36501+200n
[Pr.462] Cam axis position restoration object	<ul style="list-style-type: none"> <li>Select the object to restore the cam axis position.</li> </ul> <u>Fetch cycle: At start of synchronous control</u>	<ul style="list-style-type: none"> <li>Set in decimal.</li> <li>0: Cam axis current value per cycle restoration</li> <li>1: Cam reference position restoration</li> <li>2: Cam axis feed current value restoration</li> </ul>	0	36502+200n
[Pr.463] Setting method of cam reference position	<ul style="list-style-type: none"> <li>Select the setting method for the cam reference position.</li> <li>Set for the cam axis current value per cycle restoration or the cam axis feed current value restoration.</li> </ul> <u>Fetch cycle: At start of synchronous control</u>	<ul style="list-style-type: none"> <li>Set in decimal.</li> <li>0: Previous value</li> <li>1: Initial setting value of cam reference position</li> <li>2: Feed current value</li> </ul>	2	36503+200n
[Pr.464] Setting method of cam axis current value per cycle	<ul style="list-style-type: none"> <li>Select the setting method for the cam axis current value per cycle.</li> <li>Set for the cam reference position restoration or the cam axis feed current value restoration.</li> </ul> <u>Fetch cycle: At start of synchronous control</u>	<ul style="list-style-type: none"> <li>Set in decimal.</li> <li>0: Previous value</li> <li>1: Initial setting value of cam axis current value per cycle</li> <li>2: Current value per cycle after main shaft gear</li> <li>3: Current value per cycle after auxiliary shaft gear</li> </ul>	0	36504+200n
[Pr.465] Current value per cycle after main shaft gear (Initial setting)	<ul style="list-style-type: none"> <li>Set the initial value of the current value per cycle after main shaft gear.</li> </ul> <u>Fetch cycle: At start of synchronous control</u>	<ul style="list-style-type: none"> <li>Set in decimal.</li> <li>0 to (Cam axis length per cycle - 1)</li> <li>[Cam axis cycle units <sup>(Note-1)</sup>]</li> </ul>	0	36506+200n 36507+200n
[Pr.466] Current value per cycle after auxiliary shaft gear (Initial setting)	<ul style="list-style-type: none"> <li>Set the initial value of the current value per cycle after auxiliary shaft gear.</li> </ul> <u>Fetch cycle: At start of synchronous control</u>	<ul style="list-style-type: none"> <li>Set in decimal.</li> <li>0 to (Cam axis length per cycle - 1)</li> <li>[Cam axis cycle units <sup>(Note-1)</sup>]</li> </ul>	0	36508+200n 36509+200n
[Pr.467] Cam reference position (Initial setting)	<ul style="list-style-type: none"> <li>Set the initial value of the cam reference position.</li> </ul> <u>Fetch cycle: At start of synchronous control</u>	<ul style="list-style-type: none"> <li>Set in decimal.</li> <li>-2147483648 to 2147483647</li> <li>[Output axis position units <sup>(Note-2)</sup>]</li> </ul>	0	36510+200n 36511+200n

n: Axis No.-1

(Note-1): Cam axis cycle units (Refer to Section 4.5.1)

(Note-2): Output axis position units (Refer to Section 4.5.1)

Setting item	Setting details	Setting value	Default value	Buffer memory address
[Pr.468] Cam axis current value per cycle (Initial setting)	<ul style="list-style-type: none"> <li>Set the initial value for the cam axis current value per cycle.</li> <li>The restoration value for the cam axis current value per cycle is searched from the setting value with the cam axis current value per cycle restoration.</li> </ul> <p>Fetch cycle: At start of synchronous control</p>	<p>■ Set in decimal. 0 to (Cam axis length per cycle - 1) [Cam axis cycle units <sup>(Note-1)</sup>]</p>	0	36512+200n 36513+200n

n: Axis No.-1

(Note-1): Cam axis cycle units (Refer to Section 4.5.1)

**[Pr.460] Setting method of current value per cycle after main shaft gear**

Select the setting method of "[Md.401] Current value per cycle after main shaft gear" when starting synchronous control.

- 0: Previous value ..... The current value per cycle after main shaft gear from the last synchronous control session is stored.
- 1: Initial setting value of current value per cycle after main shaft gear ..... The value set in "[Pr.465] Current value per cycle after main shaft gear (Initial setting)" is stored.
- 2: Calculate from input axis ..... The value calculated based on the current value after composite main shaft gear is stored.

**[Pr.461] Setting method of current value per cycle after auxiliary shaft gear**

Select the setting method of "[Md.402] Current value per cycle after auxiliary shaft gear" when starting synchronous control.

- 0: Previous value ..... The current value per cycle after auxiliary shaft gear from the last synchronous control session is stored.
- 1: Initial setting value of current value per cycle after auxiliary shaft gear ..... The value set in "[Pr.466] Current value per cycle after auxiliary shaft gear (Initial setting)" is stored.
- 2: Calculate from input axis ..... The value calculated based on the auxiliary shaft current value is stored.

[Pr.462] Cam axis position restoration object

Select the object to be restored from "Cam axis current value per cycle", "Cam reference position" or "Cam axis feed current value" when starting synchronous control.

- 0: Cam axis current value per cycle restoration  
 ..... Restore the cam axis current value per cycle from "Cam reference position" and "Cam axis feed current value".
- 1: Cam reference position restoration..... Restore the cam reference position from "Cam axis current value per cycle" and "Cam axis feed current value".
- 2: Cam axis feed current value restoration  
 ..... Restore the cam axis feed current value from "Cam axis current value per cycle" and "Cam reference position".

[Pr.463] Setting method of cam reference position

Select the method for the cam reference position to be restored when "[Pr.462] Cam axis position restoration object" is set to "0: Cam axis current value per cycle restoration" or "2: Cam axis feed current value restoration".

- 0: Previous value ..... The cam reference position from the last synchronous control session is stored. The feed current value is stored when the cam reference position from the last synchronous control session is not saved.
- 1: Initial setting value of cam reference position  
 ..... The value set in "[Pr.467] Cam reference position (Initial setting)" is stored.
- 2: Feed current value ..... The value set in "[Md.20] Feed current value" is stored.

[Pr.464] Setting method of cam axis current value per cycle

Select the method for the cam axis current value per cycle to be restored when "[Pr.462] Cam axis position restoration object" is set to "1: Cam reference position restoration" or "2: Cam axis feed current value restoration".

- 0: Previous value ..... The cam axis current value per cycle from the last synchronous control session is stored as is.
- 1: Initial setting value of cam axis current value per cycle  
 ..... The value set in "[Pr.468] Cam axis current value per cycle (Initial setting)" is stored.
- 2: Current value per cycle after main shaft gear  
 ..... The current value per cycle after main shaft gear is stored.
- 3: Current value per cycle after auxiliary shaft gear  
 ..... The current value per cycle after auxiliary shaft gear is stored.

[Pr.465] Current value per cycle after main shaft gear (Initial setting)

Set the initial setting value of the current value per cycle after main shaft gear when "[Pr.460] Setting method of current value per cycle after main shaft gear" is set to "1: Current value per cycle after main shaft gear (Initial setting)".

The unit settings are in cam axis cycle units (Refer to Section 4.5.1). Set within the range from 0 to (Cam axis length per cycle - 1).

[Pr.466] Current value per cycle after auxiliary shaft gear (Initial setting)

Set the initial setting value of the current value per cycle after auxiliary shaft gear when "[Pr.461] Setting method of current value per cycle after auxiliary shaft gear" is set to "1: Current value per cycle after auxiliary shaft gear (Initial setting)".

The unit settings are in cam axis cycle units (Refer to Section 4.5.1). Set within the range from 0 to (Cam axis length per cycle - 1).

[Pr.467] Cam reference position (Initial setting)

Set the initial setting value of the cam reference position in output axis position units (Refer to Section 4.5.1) when "[Pr.463] Setting method of cam reference position" is set to "1: Cam reference position (Initial setting)".

[Pr.468] Cam axis current value per cycle (Initial setting)

Set a value according to the setting for "[Pr.462] Cam axis position restoration object".

The unit settings are in cam axis cycle units (Refer to Section 4.5.1). Set within the range from 0 to (Cam axis length per cycle - 1).

[Pr.462] Cam axis position restoration object	Setting value
0: Cam axis current value per cycle restoration	Set the starting point for search processing to restore the cam axis current value per cycle. Set to restore the position on the return path in two-way cam pattern operation. Refer to Section 5.3.1 for details on search processing.
1: Cam reference position restoration	Set the initial setting value for the cam axis current value per cycle when "[Pr.464] Setting method of cam axis current value per cycle" is set to "1: Cam axis current value per cycle (Initial setting)".
2: Cam axis feed current value restoration	

## 5.3 Cam axis position restoration method

### 5.3.1 Cam axis current value per cycle restoration

If "[Pr.462] Cam axis position restoration object" is set to "0: Cam axis current value per cycle restoration" when starting synchronous control, the cam axis current value per cycle is restored based on the cam reference position and the cam axis feed current value.

Select the method for the cam reference position to be restored. The feed current value when starting synchronous control is used as the cam axis feed current value.

The cam axis current value per cycle is restored by searching for the corresponding value from the beginning to the end of the cam pattern. Set the starting point from where to search the cam pattern in "[Pr.468] Cam axis current value per cycle (Initial setting)". (It is also possible to search the return path in a two-way cam pattern operation.)

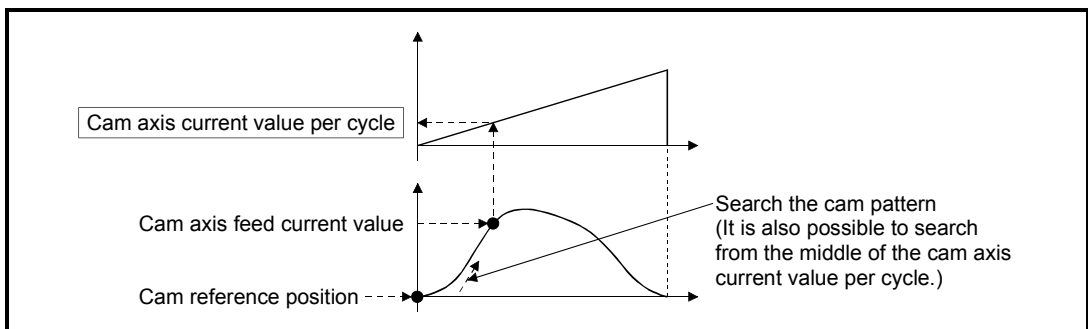
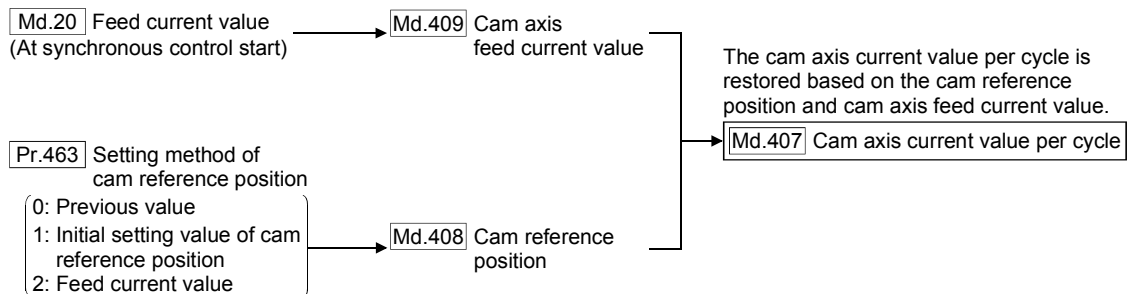

#### ■ Restrictions

- (1) With two-way cam pattern operation, if the corresponding cam axis current value per cycle is not found, the error "Cam axis current value per cycle restoration disable" (error code: 768) will occur and synchronous control will not be started.
- (2) When starting synchronous control, the feed current value may change slightly from its original position at starting synchronous control. This is due to the readjustment of the position based on the restored cam axis current value per cycle. This does not result in position displacement.
- (3) With a feed operation cam pattern, if the corresponding cam axis current value per cycle is not found on the first cycle, the cam reference position is changed automatically and the pattern is searched again.
- (4) If the cam resolution is large, search processing may take a long time when starting synchronous control. (Cam resolution 32768: up to about 10ms)

■ Cam axis current value per cycle restoration operation

(1) With a two-way cam pattern operation

- (a) Search from "Cam axis current value per cycle = 0".  
(Cam data starting point = 0)

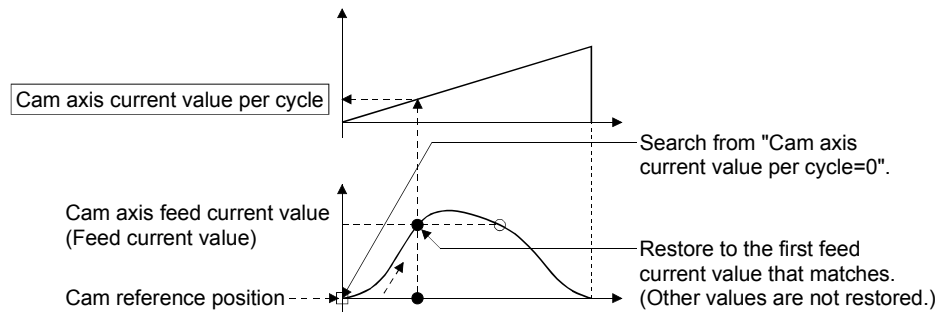

- (b) Search from a value in the middle of the cam axis current value per cycle.  
(Cam data starting point = 0)

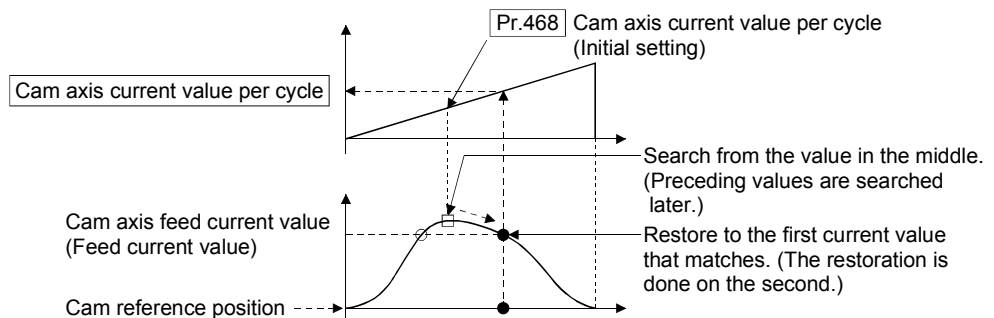

- (c) Search from a value in the middle of the cam axis current value per cycle.  
(Cam data starting point ≠ 0)

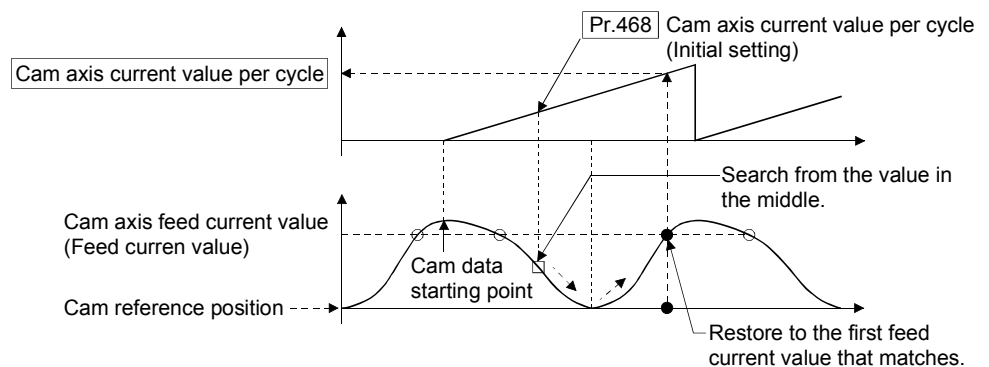



(d) The search fails.

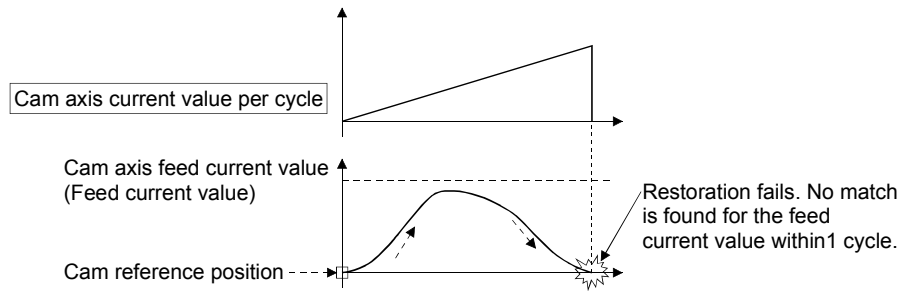

(2) With a feed operation cam pattern

(a) Search from "Cam axis current value per cycle = 0".  
(Cam data starting point = 0)

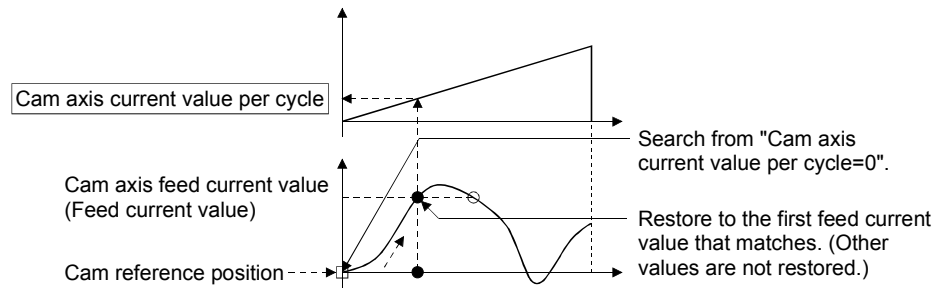

(b) Search from a value in the middle of the cam axis current value per cycle.  
(Cam data starting point = 0)

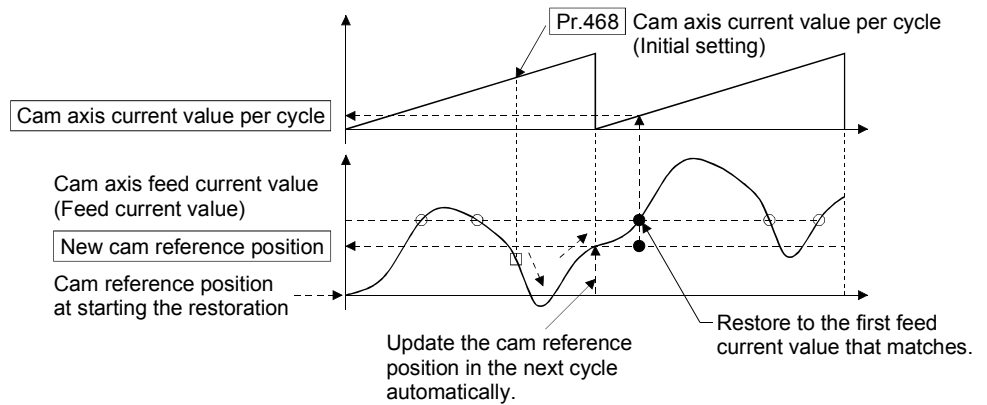

(c) Search from a value in the middle of the cam axis current value per cycle.  
 (Cam data starting point  $\neq 0$ )

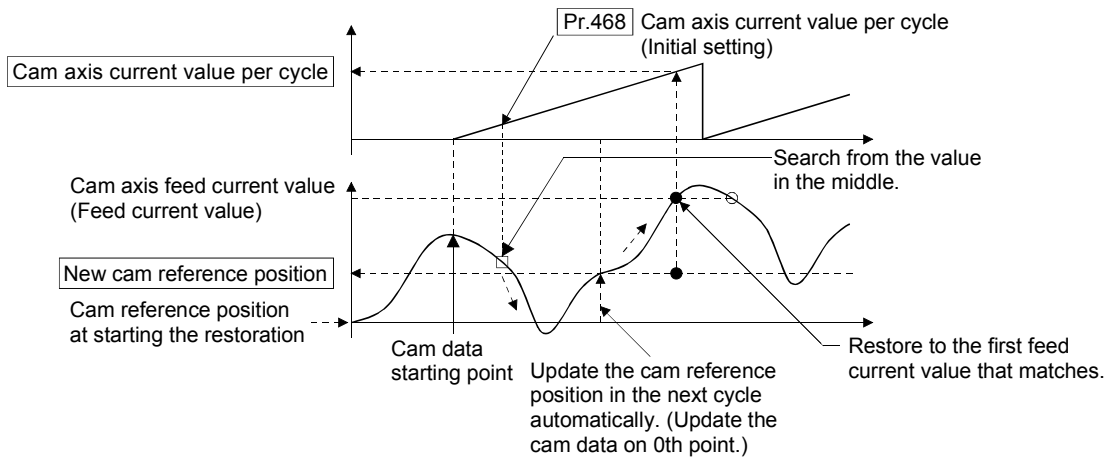

(d) The first search is fails and a search begins for the second time.

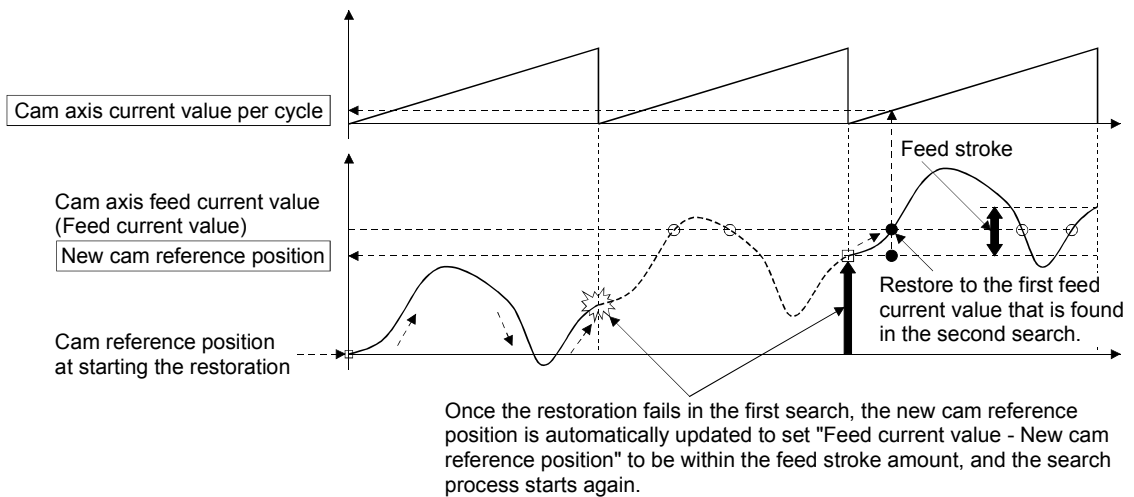

**POINT**

If the first search fails, a second search may not be processed on the next cycle for a cam pattern with a feed stroke that is smaller than 100% of the stroke as above. The intended cam axis current value per cycle can be found in the first search, by setting or positioning the cam reference position in advance.

■ Example

The following shows an example of restarting the cam (a cam similar to a cam with a linear feed where two identical positioning points do not exist on the cam) from the feed current value after a forced stop, when the forced stop has stopped operation.

If the following settings are used in a two-way cam or a cam where identical positioning points exist on the same cam, similar to the cam axis current value per cycle restoration operation (Refer to Section 5.3.1), the first matching feed current value (outward route) is restored, therefore restoration may start from an unintended cam pattern position. To avoid restoring the first matching feed current value, use cam axis feed current value restoration (Refer to Section 5.3.3).

Setting item	Setting value
[Pr.439] Cam axis length per cycle	1000 [PLS]
[Pr.441] Cam stroke amount	200 [PLS]
[Pr.462] Cam axis position restoration object	0: Cam axis current value per cycle restoration
[Pr.463] Setting method of cam reference position	1: Initial setting value of cam reference position
[Pr.464] Setting method of cam axis current value per cycle	0: Previous value
[Pr.467] Cam reference position (Initial setting)	0 [PLS]
[Pr.468] Cam axis current value per cycle (Initial setting)	0 [PLS]

• Synchronous control operation

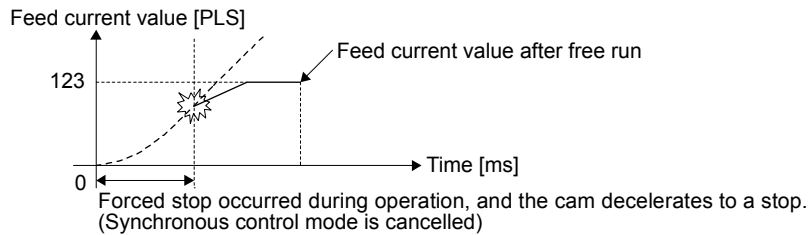

• Restore operation at restart of synchronous control

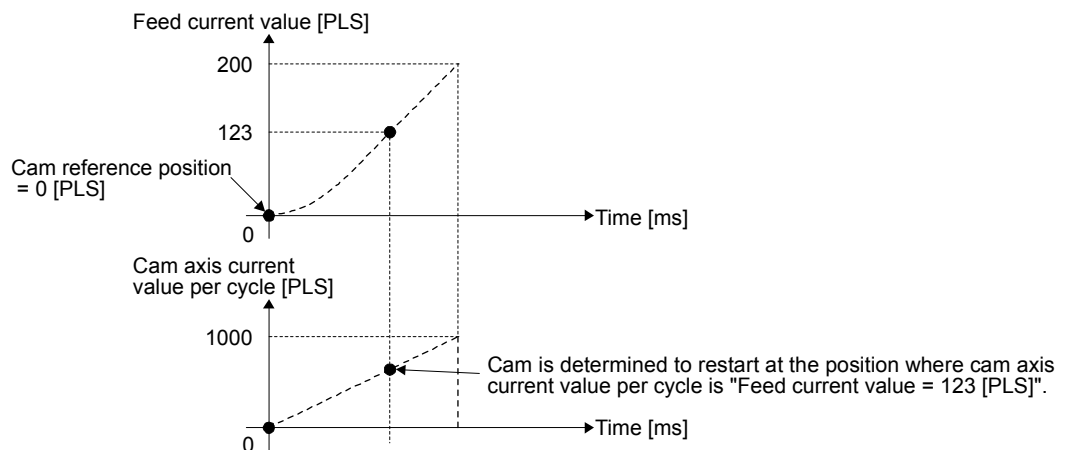

- Cam operation

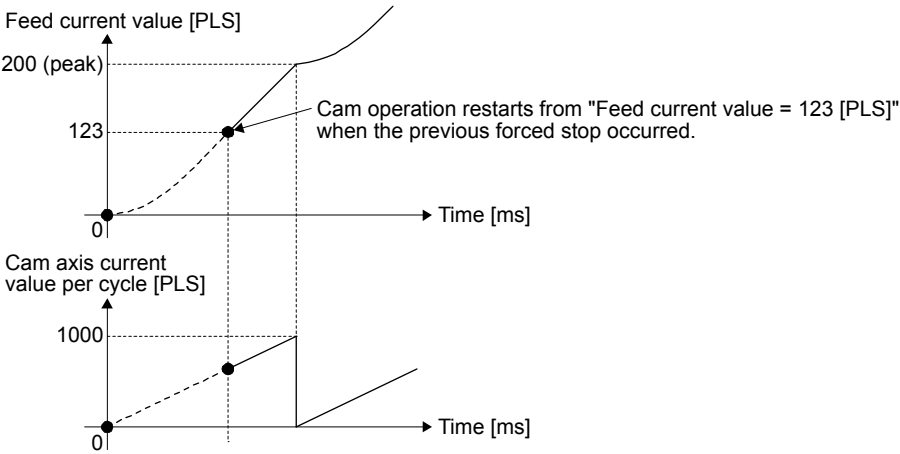

### 5.3.2 Cam reference position restoration

If "[Pr.462] Cam axis position restoration object" is set to "1: cam reference position restoration" when starting synchronous control, the cam reference position is restored based on the cam axis current value per cycle and the cam axis feed current value. Select the method for the cam axis current value per cycle to be restored. The feed current value when starting synchronous control is used as the cam axis feed current value.

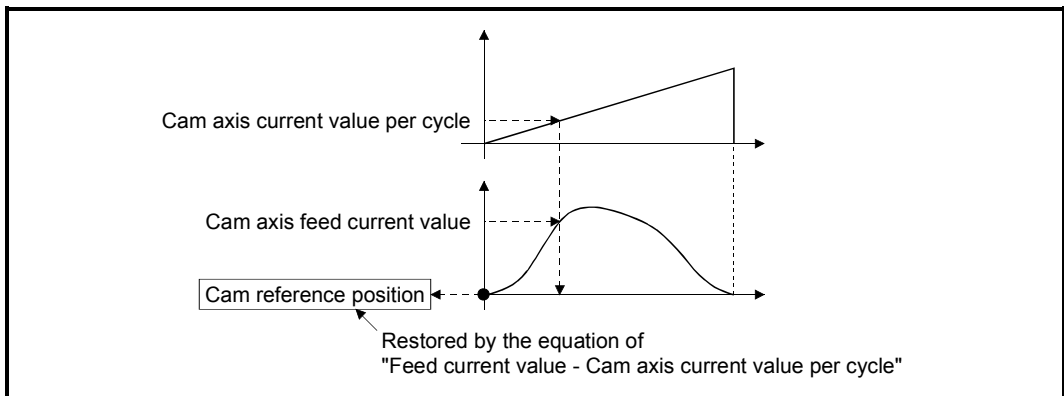
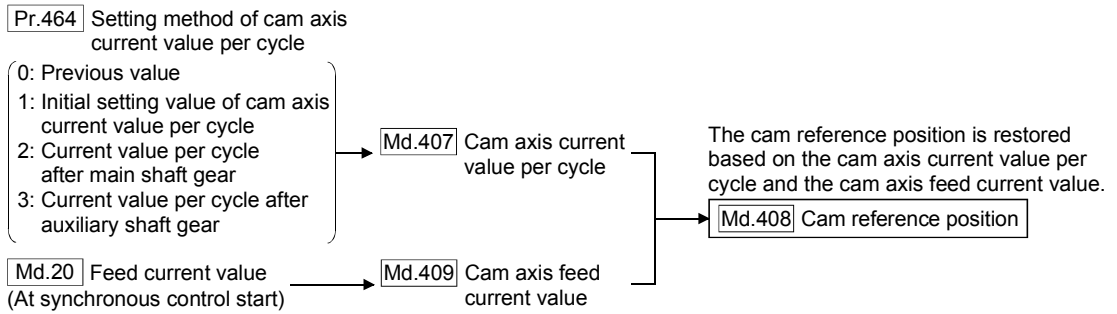

#### ■ Example

The following shows an example of starting operation from a position of "cam axis current value per cycle=0" by restoring the cam reference position when starting from "feed current value=0 [pulse]", in the cam when the cam data starting point is not 0.

Setting item	Setting value
[Pr.439] Cam axis length per cycle	1000 [PLS]
[Pr.441] Cam stroke amount	200 [PLS]
[Pr.462] Cam axis position restoration object	1: Cam reference position restoration
[Pr.463] Setting method of cam reference position	None
[Pr.464] Setting method of cam axis current value per cycle	1: Initial setting value of cam axis current value per cycle
[Pr.467] Cam reference position (Initial setting)	None
[Pr.468] Cam axis current value per cycle (Initial setting)	0 [PLS]

- Operation before starting synchronous control

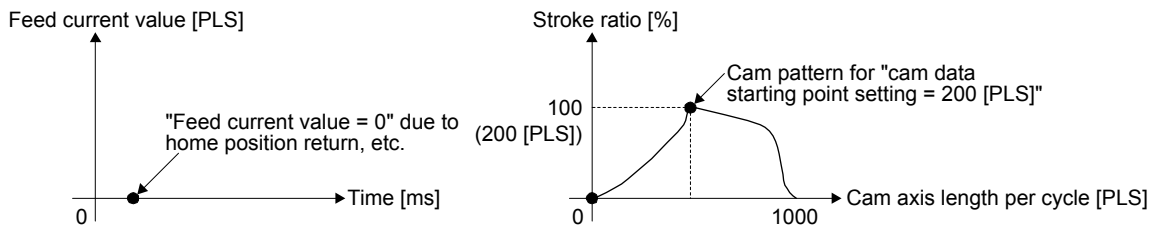

- Restore operation at start of synchronous control

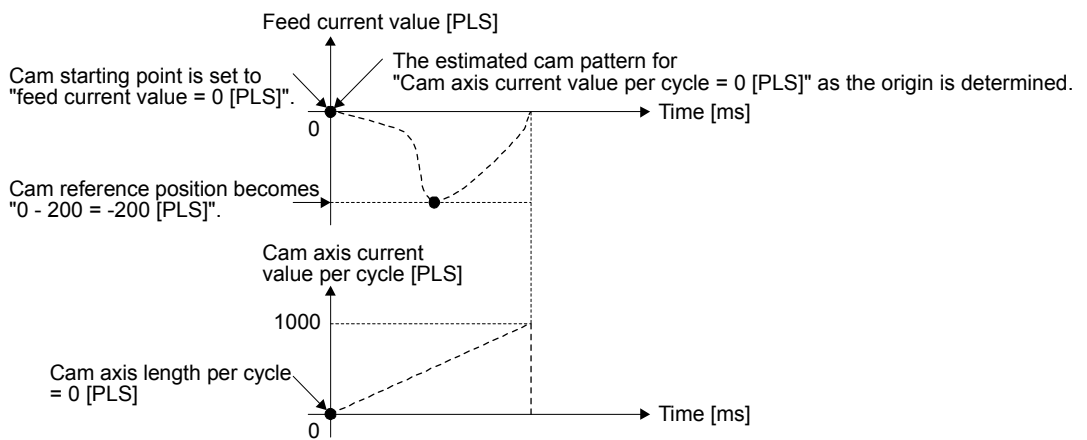

- Cam operation

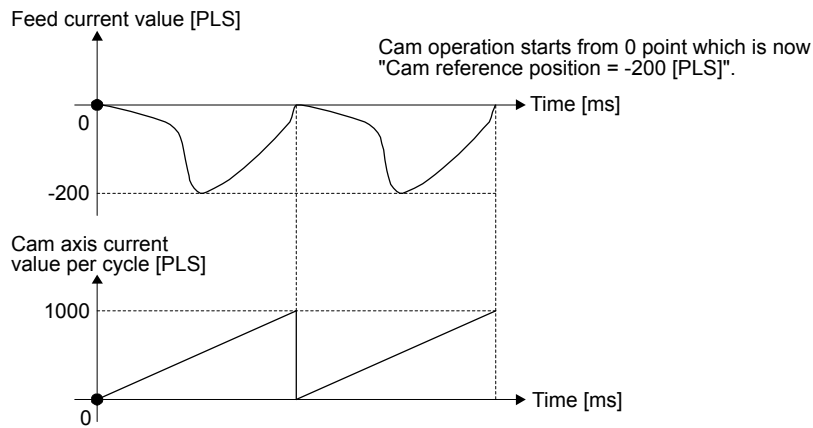

### 5.3.3 Cam axis feed current value restoration

If "[Pr.462] Cam axis position restoration object" is set to "2: Cam axis feed current value restoration" when starting synchronous control, the cam axis feed current value is restored based on the cam axis current value per cycle and the cam reference position. Select the method for the cam axis current value per cycle and the method for the cam reference position to be restored.

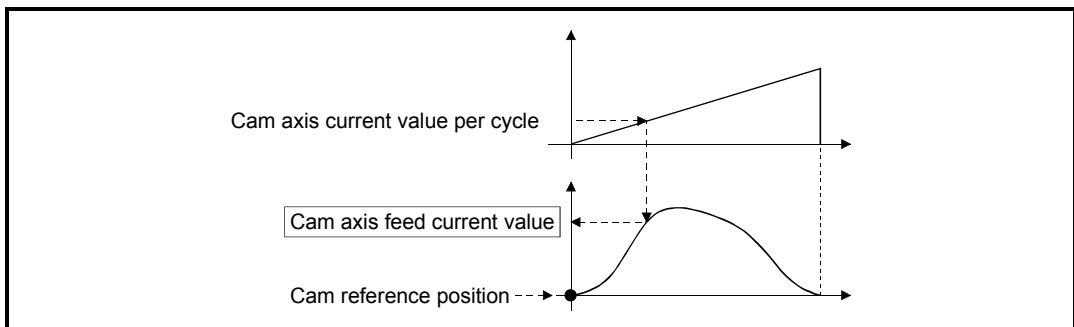
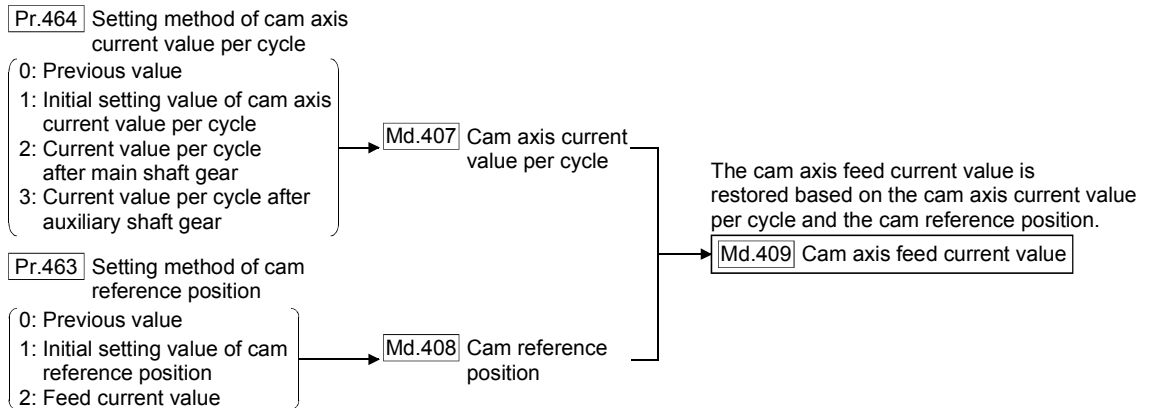

#### ■ Restrictions

The cam axis feed current value moves to its restored value just after starting synchronous control when the cam axis feed current value to be restored is different from the feed current value at synchronous control start.

If the difference is larger than "In-position width (PA10)" of servo amplifier in pulse command units, the error "Cam axis feed current value restoration disable" (error code: 769) will occur and synchronous control cannot be started.

Note that, if the setting value of "In-position width" is large, a rapid operation may occur.

**POINT**

With cam axis feed current value restoration, calculate the cam axis feed current value with the cam position calculation function (Refer to Section 5.5) or with synchronous control analysis mode (Refer to Section 5.4) before starting synchronous control. Then start synchronous control after positioning to the correct cam axis feed current value.

■ Example

The following shows an example of starting a cam pattern from the zero point of the cam axis current value per cycle with the current feed current value position as the origin when returning to a specified point, or home position return is completed after a forced stop.

Setting item	Setting value
[Pr.439] Cam axis length per cycle	1000 [PLS]
[Pr.441] Cam stroke amount	200 [PLS]
[Pr.462] Cam axis position restoration object	2: Cam axis feed current value restoration
[Pr.463] Setting method of cam reference position	2: Feed current value
[Pr.464] Setting method of cam axis current value per cycle	1: Initial setting value of cam axis current value per cycle
[Pr.467] Cam reference position (Initial setting)	None
[Pr.468] Cam axis current value per cycle (Initial setting)	0 [PLS]

- Move to synchronous control starting point

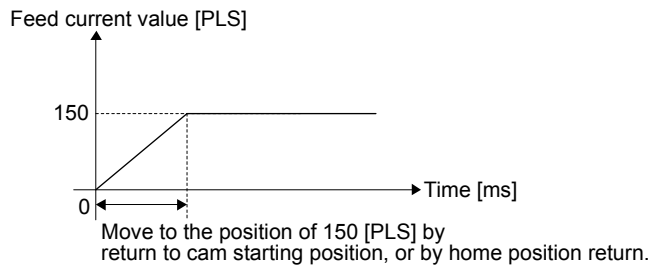

- Restore operation at start of synchronous control

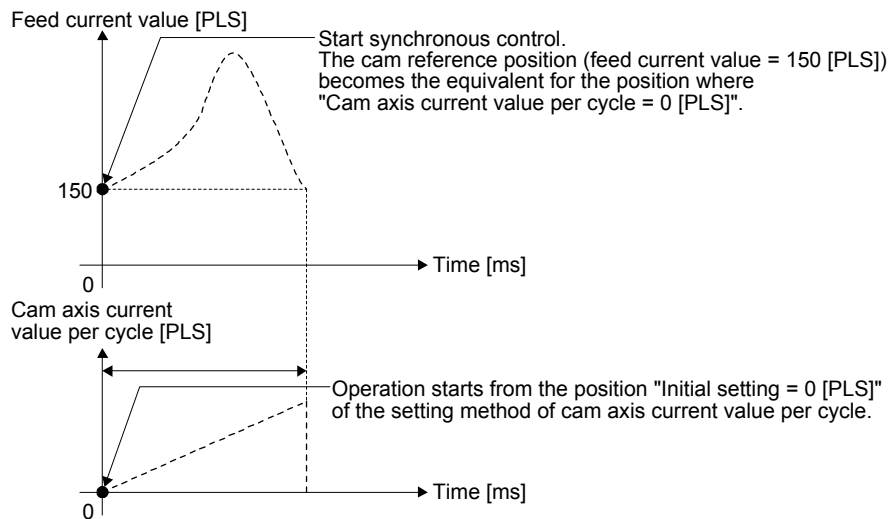



• Cam operation

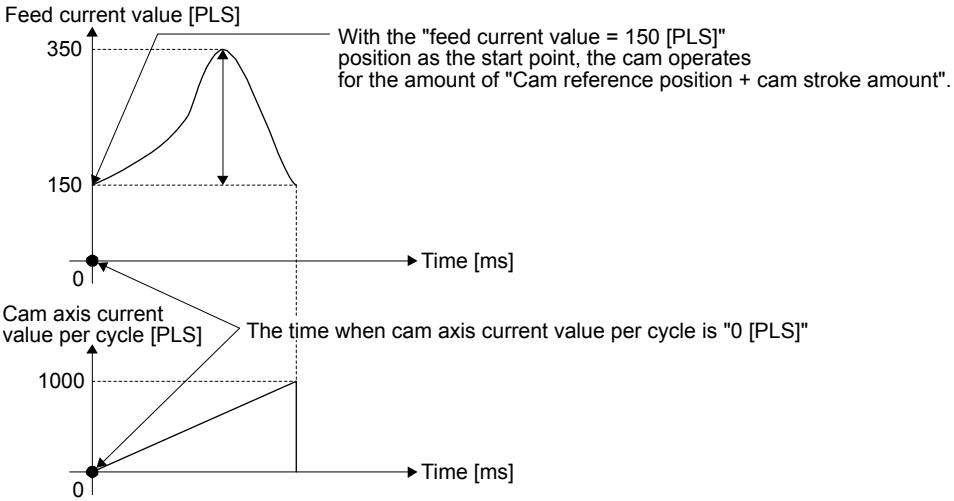

### 5.4 Synchronous control analysis mode

With synchronous control analysis mode, parameters are only analyzed for synchronous control when there is a command to start synchronous control. This mode is used to confirm the synchronous positions of the output axes in order to align axes with position control before starting synchronous control.

If the target axis bit is ON in "[Cd.381] Synchronous control analysis mode" when starting synchronous control (turning the target axis bit from OFF to ON for "[Cd.380] Synchronous control start"), operation enters synchronous control analysis mode.

When the synchronization position analysis is completed, the synchronous control monitor data ([Md.400] to [Md.425]) is updated, and the target axis bit in "[Cd.380] Synchronous control start" turns OFF.

The busy signal is not turned ON during synchronous control analysis mode.

When starting synchronous control with synchronous control analysis mode, the following error does not occur.

- Cam axis feed current value restoration disable (error code: 769)

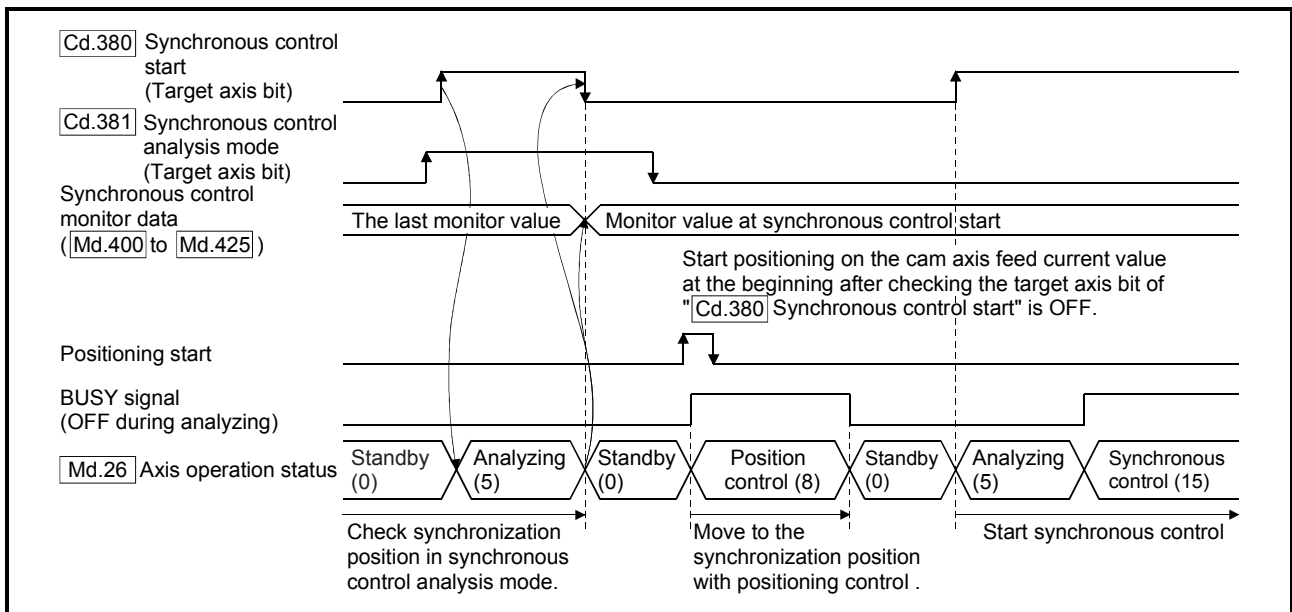

### ■ Synchronous control system control data

Setting item	Setting details	Setting value	Default value	Buffer memory address
[Cd.380] Synchronous control start	<ul style="list-style-type: none"> <li>Synchronous control begins if the target axis bit is turned ON.</li> <li>Synchronous control ends if the bit is turned OFF during synchronous control.</li> </ul> Fetch cycle: <u>Operation cycle</u>	<ul style="list-style-type: none"> <li>Set the target axis in 16bits. (bit0: axis 1 to bit15: axis 16 <sup>(Note-1)</sup>)</li> <li>OFF : Synchronous control end</li> <li>ON : Synchronous control start</li> </ul>	0	36320
[Cd.381] Synchronous control analysis mode	<ul style="list-style-type: none"> <li>If the target axis bit is turned ON and synchronous control is started, the analysis is only executed and the control does not start.</li> </ul> Fetch cycle: <u>At start of the synchronous control</u>	<ul style="list-style-type: none"> <li>Set the target axis in 16bits. (bit0: axis 1 to bit15: axis 16 <sup>(Note-1)</sup>)</li> <li>OFF : Synchronous control analysis mode OFF</li> <li>ON : Synchronous control analysis mode ON</li> </ul>	0	36322

(Note-1): The range from axis 1 to 2 is valid in the 2-axis module, from axis 1 to 4 is valid in the 4-axis module, from axis 1 to 8 is valid in the 8-axis module, and from axis 1 to 16 is valid in the 16-axis module.

### ■ Example

The following shows a procedure of aligning the synchronous position of an output axis that references the input axis.

- 1) Set the following values in the synchronous control initial position parameters.

Setting item	Setting value
[Pr.460] Setting method of current value per cycle after main shaft gear	2: Calculate from input axis
[Pr.462] Cam axis position restoration object	2: Cam axis feed current value restoration
[Pr.463] Setting method of cam reference position	0: Previous value
[Pr.464] Setting method of cam axis current value per cycle	2: Current value per cycle after main shaft gear

- 2) Turn ON the target axis bit of "[Cd.381] Synchronous control analysis mode", and then turn the target axis bit from OFF to ON in "[Cd.380] Synchronous control start" to start the synchronous control analysis mode.
- 3) Verify the target axis bit is OFF for "[Cd.380] Synchronous control start", and execute positioning for the output axis to be updated to "[Md.409] Cam axis feed current value".
- 4) Turn OFF the target axis bit of "[Cd.381] Synchronous control analysis mode", and then turn the target axis bit from OFF to ON in "[Cd.380] Synchronous control start" to start synchronous control.

## 5.5 Cam position calculation function

The cam position is calculated by the program with this function. This function can be used to calculate the cam position for the synchronous control initial position before starting synchronous control.

### ■ Example

The following shows the procedure for synchronous position alignment, in a synchronous system where cam axes 2 and 3 are synchronized with the cam axis current value per cycle of axis 1.

- 1) Calculate the cam axis current value per cycle using this function based on the feed current value and the cam reference position of axis 1.
- 2) Calculate the cam axis feed current value of axis 2 with this function based on the cam axis current value per cycle that was calculated in 1).
- 3) Calculate the cam axis feed current value of axis 3 with this function based on the cam axis current value per cycle that was calculated in 1).
- 4) Execute positioning on axis 2 to the cam axis feed current value which was calculated in 2), and also on axis 3 to the cam axis feed current value which was calculated in 3).
- 5) Start synchronous control on axis 1, 2 and 3 with the feed current value restoration mode. Use the cam axis current value per cycle that was calculated in 1) for the cam axis current value per cycle (Initial setting).

## 5.5.1 Cam position calculation control data

Setting item	Setting details	Setting value	Default value	Buffer memory address
[Cd.612] Cam position calculation request	<ul style="list-style-type: none"> <li>Set the cam position calculation request.</li> <li>The Simple Motion module resets the value to "0" automatically after completion of the cam position calculation.</li> </ul> Fetch cycle: Main cycle <sup>(Note-1)</sup>	<ul style="list-style-type: none"> <li>Set in decimal.</li> <li>1: Cam axis feed current value calculation request</li> <li>2: Cam axis current value per cycle calculation request</li> </ul>	0	53780
[Cd.613] Cam position calculation: Cam No.	<ul style="list-style-type: none"> <li>Set the cam No. for the cam position calculation.</li> </ul> Fetch cycle: At requesting cam position calculation	<ul style="list-style-type: none"> <li>Set in decimal.</li> <li>0 to 256</li> </ul>	0	53781
[Cd.614] Cam position calculation: Stroke amount	<ul style="list-style-type: none"> <li>Set the cam stroke amount for the cam position calculation.</li> </ul> Fetch cycle: At requesting cam position calculation	<ul style="list-style-type: none"> <li>Set in decimal.</li> <li>-2147483648 to 2147483647</li> <li>[Output axis position units <sup>(Note-2)</sup>]</li> </ul>	0	53782 53783
[Cd.615] Cam position calculation: Cam axis length per cycle	<ul style="list-style-type: none"> <li>Set the cam axis length per cycle for the cam position calculation.</li> </ul> Fetch cycle: At requesting cam position calculation	<ul style="list-style-type: none"> <li>Set in decimal.</li> <li>1 to 2147483647</li> <li>[Cam axis cycle units <sup>(Note-3)</sup>]</li> </ul>	0	53784 53785
[Cd.616] Cam position calculation: Cam reference position	<ul style="list-style-type: none"> <li>Set the cam reference position for the cam position calculation.</li> </ul> Fetch cycle: At requesting cam position calculation	<ul style="list-style-type: none"> <li>Set in decimal.</li> <li>-2147483648 to 2147483647</li> <li>[Output axis position units <sup>(Note-2)</sup>]</li> </ul>	0	53786 53787
[Cd.617] Cam position calculation: Cam axis current value per cycle	<ul style="list-style-type: none"> <li>Set the cam axis current value per cycle for the cam position calculation.</li> </ul> Fetch cycle: At requesting cam position calculation	<ul style="list-style-type: none"> <li>Set in decimal.</li> <li>0 to (Cam axis length per cycle)</li> <li>[Cam axis cycle units <sup>(Note-3)</sup>]</li> </ul>	0	53788 53789
[Cd.618] Cam position calculation: Cam axis feed current value	<ul style="list-style-type: none"> <li>Set the cam axis feed current value for the cam position calculation. (Set when calculating the cam axis current value per cycle.)</li> </ul> Fetch cycle: At requesting cam position calculation	<ul style="list-style-type: none"> <li>Set in decimal.</li> <li>-2147483648 to 2147483647</li> <li>[Output axis position units <sup>(Note-2)</sup>]</li> </ul>	0	53790 53791

(Note-1): With the exception of positioning control, main cycle processing is executed during the next available time. It changes by status of axis start.

(Note-2): Output axis position units (Refer to Section 4.5.1)

(Note-3): Cam axis cycle units (Refer to Section 4.5.1)

[Cd.612] Cam position calculation request

Set the following commands to calculate the cam position.

1: Cam axis feed current value calculation request

2: Cam axis current value per cycle calculation request

The result is stored in "[Md.600] Cam position calculation result" and the setting value is reset to "0" automatically after completion of cam position calculation.

If warnings occur when requesting the cam position calculation, the warning number is stored in "[Md.24] Axis warning No." of axis 1 and the setting value is reset to "0" automatically.

When a value other than the request command values listed above is set, this calculation does not get executed and the setting value is reset to "0" automatically.

[Cd.613] Cam position calculation: Cam No.

Set the cam No. for the cam position calculation. If 0 is set for the cam No., the cam position is calculated as a linear cam.

[Cd.614] Cam position calculation: Stroke amount

Set the cam stroke amount for the cam position calculation.

[Cd.615] Cam position calculation: Cam axis length per cycle

Set the cam axis length per cycle for the cam position calculation.

[Cd.616] Cam position calculation: Cam reference position

Set the cam reference position for the cam position calculation.

[Cd.617] Cam position calculation: Cam axis current value per cycle

Set the cam axis current value per cycle for the cam position calculation when calculating the cam axis feed current value.

Set the cam axis current value per cycle as the starting point to search when calculating the cam axis current value per cycle and the cam position.

[Cd.618] Cam position calculation: Cam axis feed current value

Set the cam axis feed current value for the cam position calculation when calculating the cam axis current value per cycle.

This is not used when calculating the cam axis feed current value.

5.5.2 Cam position calculation monitor data

Monitor item	Storage details	Monitor value	Buffer memory address
[Md.600] Cam position calculation result	<ul style="list-style-type: none"> <li>The result of the cam position calculation is stored.</li> </ul> <p><u>Refresh cycle: At cam position calculation completion</u></p>	<ul style="list-style-type: none"> <li>Monitoring is carried out in decimal.</li> <li>When calculating the cam axis feed current value: -2147483648 to 2147483647 [Output axis position units <sup>(Note-1)</sup>]</li> <li>When calculating the cam axis current value per cycle: 0 to (Cam axis length per cycle - 1) [Cam axis cycle units <sup>(Note-2)</sup>]</li> </ul>	<p>53800</p> <p>53801</p>

(Note-1): Output axis position units (Refer to Section 4.5.1)

(Note-2): Cam axis cycle units (Refer to Section 4.5.1)

[Md.600] Cam position calculation result

The result of the cam position calculation is stored.

When calculating the cam axis feed current value

..... Calculated value of the cam axis feed current value is stored.

When calculating the cam axis current value per cycle

..... Calculated value of the cam axis current value per cycle is stored.

The cam reference position is not updated automatically by the cam position calculation function.

■ Search for the cam axis current value per cycle

When calculating the cam axis current value per cycle using cam data, the position corresponding to "[Cd.618] Cam position calculation: Cam axis feed current value" is searched using cam data based on the position specified by "[Cd.617] Cam position calculation: Cam axis current value per cycle".

The following shows the order of the search for "[Cd.618] Cam position calculation: Cam axis feed current value".

[Stroke ratio data format]

When "the nth point of cam data  $\leq$  [Cd.617] Cam position calculation: Cam axis current value per cycle < the n + 1st point of cam data", the position corresponding to "[Cd.618] Cam position calculation: Cam axis feed current value" is searched from the nth point of cam data.

If "[Cd.617] Cam position calculation: Cam axis current value per cycle" is in the middle of the cam data and the corresponding position is not found until the last point of the cam data, return to the 0th point and search until the search starting point.

If the corresponding position is not found even though the whole area of the cam data has been searched, the warning "Cam position calculation cam axis 1 cycle current value calculation disable" (warning code: 834) will occur in reciprocated cam pattern.

For the feed cam, calculates "[Cd.618] Cam position calculation: Cam axis feed current value" by the stroke difference and searches again from the 0th point to the whole range. If the corresponding position is not found even though the search process starts again, the warning "Cam position calculation cam axis 1 cycle current value calculation disable" (warning code: 834) will occur.

Example) When "[Cd.617] Cam position calculation: Cam axis current value per cycle" is corresponding to the 0th point of cam data

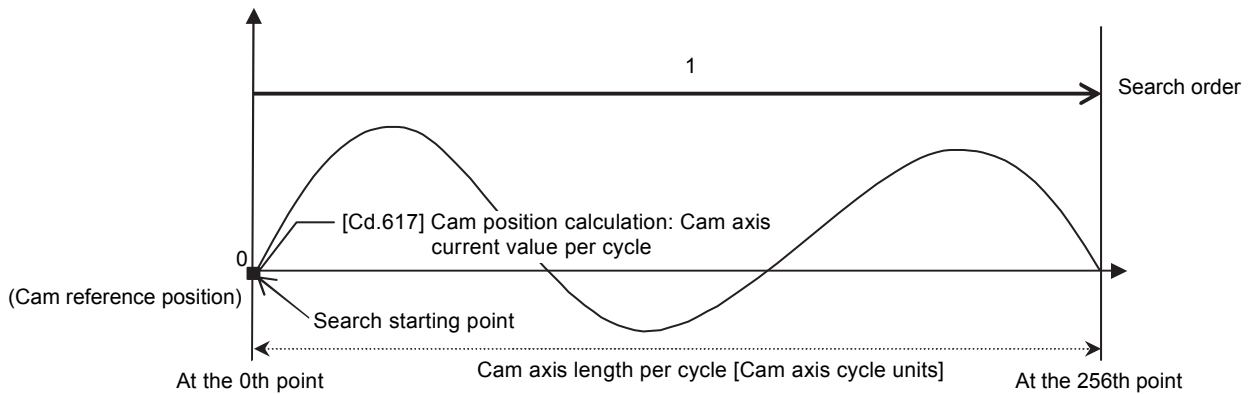

- Searches until between the 255th point and the 256th point (last point) in order of the cam data between the 0th point and the 1st point and between the 1st point and the 2nd point.

Example) When "[Cd.617] Cam position calculation: Cam axis current value per cycle" is corresponding to the 128th point of cam data

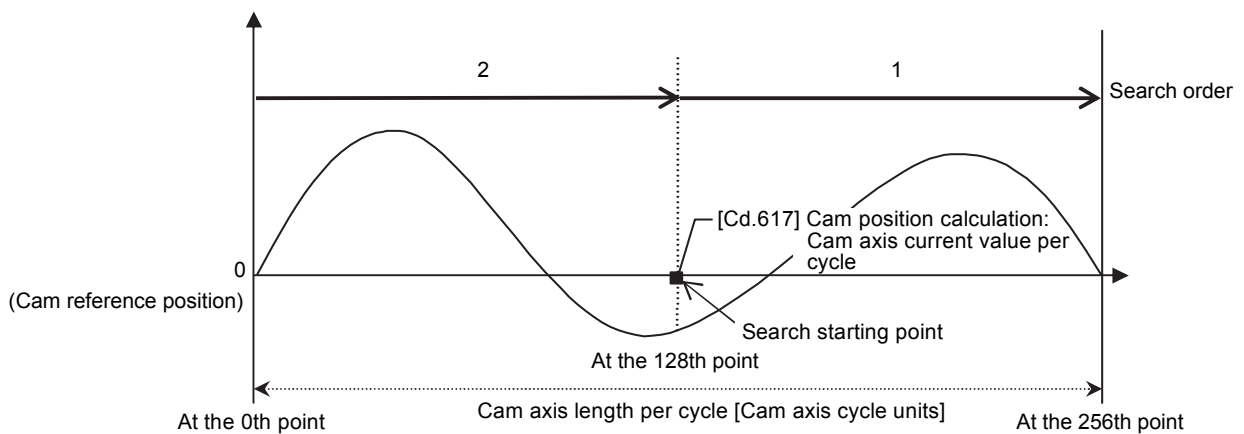

- Searches until between the 255th point and the 256th point (last point) in order of the cam data between the 128th point and the 129th point and between the 130th point and the 131th point.



- If the corresponding position is not found until the last point of the cam data, searches from the 0th point of the cam data.
- Searches until between the 127th point and the 128th point in order of the cam data between the 0th point and the 1st point and between the 1st point and the 2nd point.

[Coordinate data format]

(1) The range before the 1st point of cam data

When the 1st point of the cam data is larger than 0 and "[Cd.617] Cam position calculation: Cam axis current value per cycle < the 1st point of cam data", the position corresponding to "[Cd.618] Cam position calculation: Cam axis feed current value" is searched from the range before the 1st point of the cam data. If the corresponding position is not found in the range of (1), searches in the range of (2). If the corresponding position is not found in the range of (2) either, searches in the range of (3).

If the corresponding position is not found even though the range of (1) to (3) has been searched, the warning "Cam position calculation cam axis 1 cycle current value calculation disable" (warning code: 834) will occur in reciprocated cam pattern.

For the feed cam, calculates "[Cd.618] Cam position calculation: Cam axis feed current value" by the stroke difference and searches again from the 0th point to the whole range. If the corresponding position is not found even though the search process starts again, the warning "Cam position calculation cam axis 1 cycle current value calculation disable" (warning code: 834) will occur.

Example) When "[Cd.617] Cam position calculation: Cam axis current value per cycle" is set before the 1st point of cam data

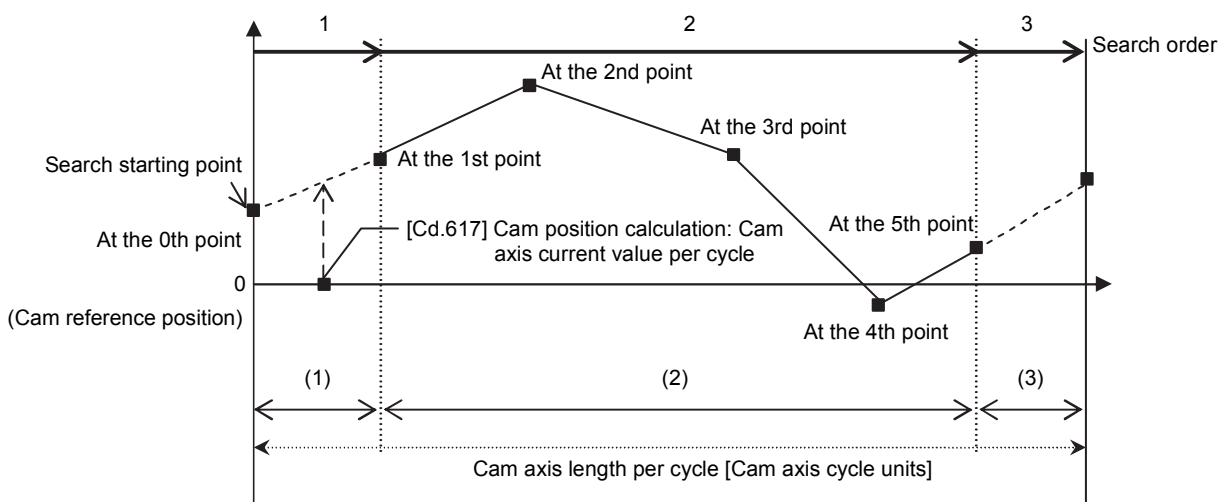

- Searches from the range of (1).
- If the corresponding position is not found in the range of (1), searches from the 1st point of the cam data in the range of (2).

(2) The range within the cam data

When "[Cd.617] Cam position calculation: Cam axis current value per cycle < the last point of cam data", the position corresponding to "[Cd.618] Cam position calculation: Cam axis feed current value" is searched from the range of the cam data.

When "the nth point of cam data ≤ [Cd.617] Cam position calculation: Cam axis current value per cycle < the n + 1st point of cam data", the position corresponding to "[Cd.618] Cam position calculation: Cam axis feed current value" is searched from the nth point of cam data.

If "[Cd.617] Cam position calculation: Cam axis current value per cycle" is in the middle of the cam data and the corresponding position is not found until the last point of the cam data, returns to the 1st point and searches until the search starting point.

If the corresponding position is not found in the range of (2), searches in the range of (3).

If the corresponding position is not found even though the range of (2) and (3) has been searched, the warning "Cam position calculation cam axis 1 cycle current value calculation disable" (warning code: 834) will occur in reciprocated cam pattern.

For the feed cam, calculates "[Cd.618] Cam position calculation: Cam axis feed current value" by the stroke difference and searches again from the 0th point to the whole range. If the corresponding position is not found even though the search process starts again, the warning "Cam position calculation cam axis 1 cycle current value calculation disable" (warning code: 834) will occur.

Example) When "[Cd.617] Cam position calculation: Cam axis current value per cycle" is corresponding to the 1st point of cam data

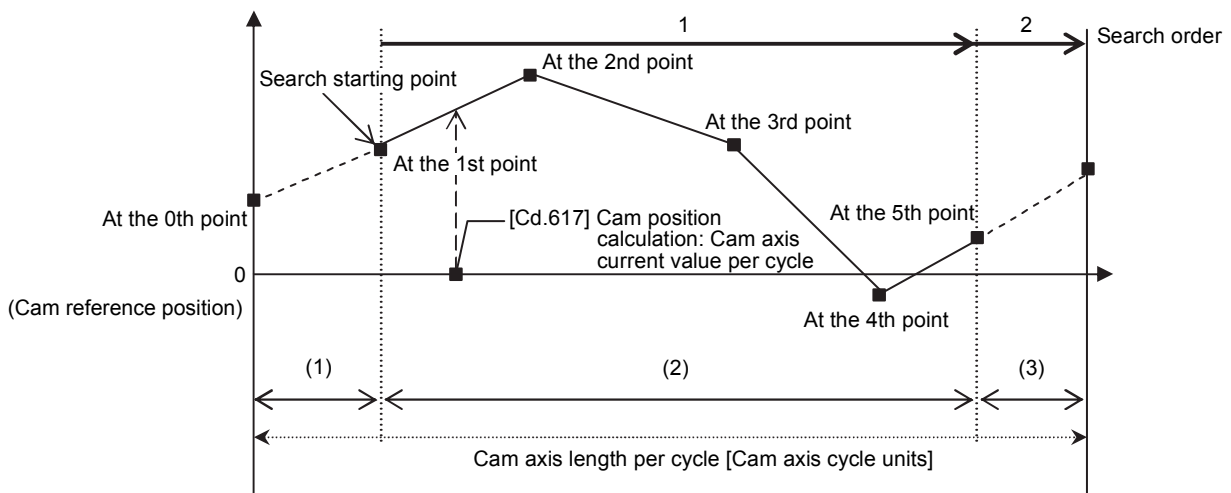

- Searches until between the 4th point and the 5th point (last point) in order of the cam data between the 1st point and the 2nd point and between the 2nd point and the 3rd point.
- If the corresponding position is not found until the last point of the cam data, searches from the range of (3).

Example) When "[Cd.617] Cam position calculation: Cam axis current value per cycle" is corresponding to the 3rd point of cam data

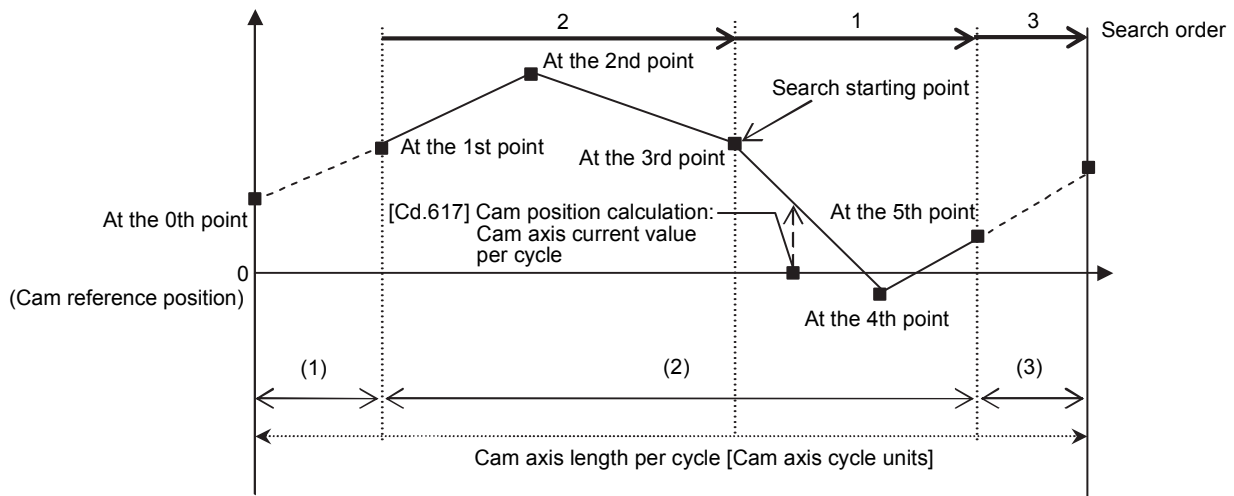

- Searches in order of the cam data between the 3rd point and the 4th point and between the 4th point and the 5th point (last point).
- If the corresponding position is not found until the last point of the cam data, searches from the 1st point of the cam data.
- If the corresponding position is not found in the cam data between the 1st point and the 2nd point and between the 2nd point and the 3rd point, searches from the range of (3).

(3) The range from the last point of cam data to the cam axis length per cycle

When "the last point of cam data  $\leq$  [Cd.617] Cam position calculation: Cam axis current value per cycle  $<$  cam axis length per cycle", the position corresponding to "[Cd.618] Cam position calculation: Cam axis feed current value" is searched from the last point of the cam data or later.

If the corresponding position is not found even though the range of (3) has been searched, the warning "Cam position calculation cam axis 1 cycle current value calculation disable" (warning code: 834) will occur in reciprocated cam pattern. For the feed cam, calculates "[Cd.618] Cam position calculation: Cam axis feed current value" by the stroke difference and searches again from the 0th point to the whole range. If the corresponding position is not found even though the search process starts again, the warning "Cam position calculation cam axis 1 cycle current value calculation disable" (warning code: 834) will occur.

Example) When "[Cd.617] Cam position calculation: Cam axis current value per cycle" is corresponding to the last point of cam data

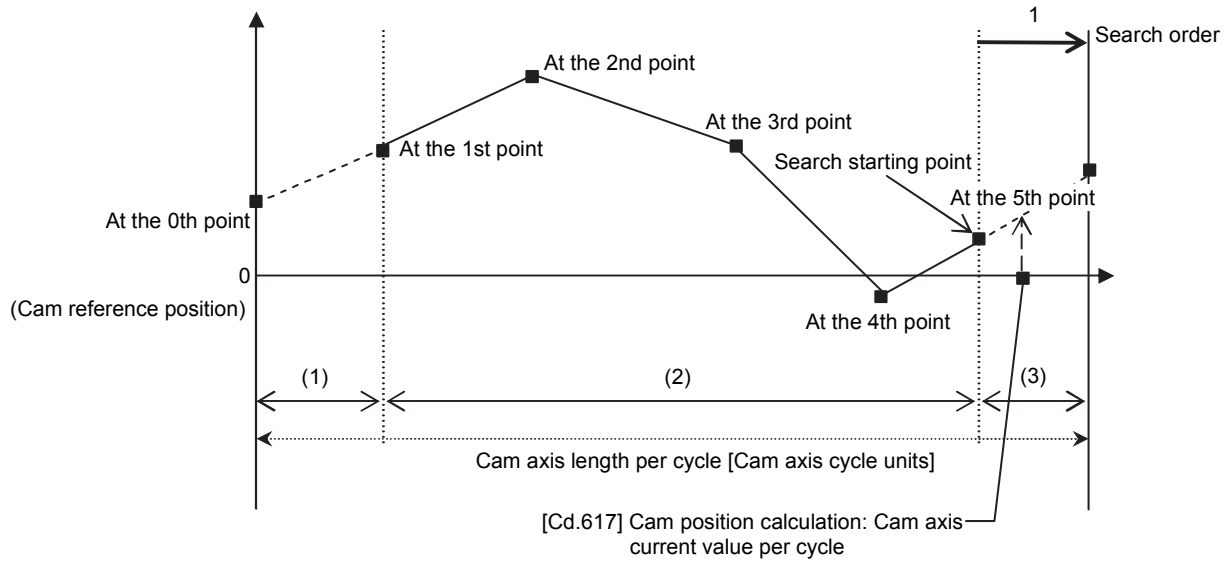

- Searches from the range of (3).

## 5.6 Method to restart synchronous control

The relationship of the synchronous position for synchronous control is always saved in the Simple Motion module. Synchronous control can be restarted without returning all axes to their starting points by restoring the synchronized relationship through the synchronous control initial position parameters (Refer to Section 5.2).

The reference axis used to restart synchronous control is different for each system. The following procedure shows an example of how to restore synchronized values based on the servo input axis as reference position.

### ■ Example

Restoring 2 output axes (axis 2, axis 3) based on the servo input axis (axis 1) as the reference position.

(Press conveyance device)

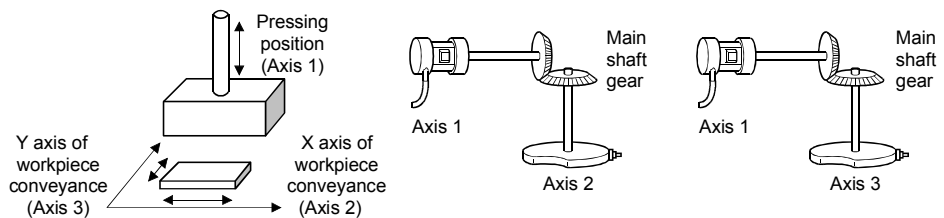

#### (1) Procedure for synchronous control (first time)

- 1) Execute HPR for axis 1, 2 and 3, and position to the synchronization starting point.
- 2) Set the synchronous control initial position parameters for axis 2 and 3 as follows.

Setting item	Setting value
[Pr.460] Setting method of current value per cycle after main shaft gear	2: Calculate from input axis
[Pr.462] Cam axis position restoration object	0: Cam axis current value per cycle restoration
[Pr.463] Setting method of cam reference position	2: Feed current value
[Pr.468] Cam axis current value per cycle (Initial setting)	0

- 3) Turn ON the bits for axis 2 and 3 in "[Cd.380] Synchronous control start" to start synchronous control.

## (2) Procedure for restarting synchronous control

- 1) Set the synchronous control initial position parameters for axis 2 and 3 as follows.

Setting item	Setting value
[Pr.460] Setting method of current value per cycle after main shaft gear	2: Calculate from input axis
[Pr.462] Cam axis position restoration object	2: Cam axis feed current value restoration
[Pr.463] Setting method of cam reference position	0: Previous value
[Pr.464] Setting method of cam axis current value per cycle	2: Current value per cycle after main shaft gear

- 2) Turn ON the bits for axes 2 and 3 in "[Cd.381] Synchronous control analysis mode", and then turn ON the bits for axes 2 and 3 in "[Cd.380] Synchronous control start" to execute the synchronous control analysis. The analyzed result is updated in [Md.400] to [Md.425].
- 3) Position axes 2 and 3 to "[Md.409] Cam axis feed current value" which has been updated in 2).
- 4) Turn OFF the bits for axes 2 and 3 in "[Cd.381] Synchronous control analysis mode", and then turn ON the bits for axes 2 and 3 in "[Cd.380] Synchronous control start" to start synchronous control.

# Chapter 6 Troubleshooting (Synchronous Control)

The "errors" and "warnings" related to synchronous control detected by the Simple Motion module are explained in this chapter.

Errors can be confirmed with the Simple Motion module LED display and GX Works2. When an error or warning is detected, check the status details and then proceed with the countermeasures.

6.1	Error and warning details .....	6- 2
6.2	Error and warning of input axis .....	6- 3
6.2.1	List of input axis errors .....	6- 4
6.2.2	List of input axis warnings .....	6- 6
6.3	Error and warning of output axis .....	6- 7
6.3.1	List of output axis errors .....	6- 7
6.3.2	List of output axis warnings .....	6-11
6.4	Warning of cam operation .....	6-12
6.4.1	List of cam data operation warnings .....	6-12
6.4.2	List of cam auto-generation warnings .....	6-14
6.4.3	List of cam position calculation warnings .....	6-15

## 6.1 Error and warning details

### [1] Error

Errors related to synchronous control are shown below. Refer to the "User's Manual (Positioning Control)" of each Simple Motion module for other errors.

Errors can be confirmed with the LED display of Simple Motion module or GX Works2. Refer to the "Simple Motion Module Setting Tool Help" of GX Works2 for details.

Error code	Classification of errors	Description
600 to 699	Synchronous control input axis errors	Section 6.2.1
700 to 799	Synchronous control output axis errors	Section 6.3.1

### [2] Warning

Warnings related to synchronous control are shown below. Refer to the "User's Manual (Positioning Control)" of each Simple Motion module for other warnings.

The warning definitions can be found from the warning codes. Confirming them requires GX Works2.

Refer to the "Simple Motion Module Setting Tool Help" of GX Works2 for details.

Warning code	Classification of warnings	Description
600 to 699	Synchronous control input axis warnings	Section 6.2.2
700 to 799	Synchronous control output axis warnings	Section 6.3.2
800 to 899	Cam operation warnings	Section 6.4



## 6.2 Error and warning of input axis

The detection processing and reset method for error and warning of input axis are different in the servo input axis and synchronous encoder axis.

### ■ Error and warning of servo input axis

#### (1) Error detection

The error detection signal for target axis turns ON, and the input axis error number is stored in "[Md.23] Axis error No."

#### (2) Warning detection

"b9: Axis warning detection" of "[Md.31] Status" turns ON, and the input axis warning number is stored in "[Md.24] Axis warning No."

#### (3) Resetting errors and warnings

Remove the cause of error or warning following the actions described in Section 6.2.1 and 6.2.2, before canceling an error or warning state through resetting the error.

An error or warning state is canceled after the following processing is carried out by setting "1" in "[Cd.5] Axis error reset" for target axis.

- Axis error detection signal is turned OFF
- "[Md.23] Axis error No." is cleared
- "[Md.24] Axis warning No." is cleared
- Changing of "[Md.26] Axis operation status" from "Error" to "Standby"
- "Axis warning detection ([Md.31] Status: b9)" is turned OFF

### ■ Error and warning of synchronous encoder axis

#### (1) Error detection

"b4: Error detection flag" of "[Md.325] Synchronous encoder axis status" for target axis turns ON, and the input axis error number is stored in "[Md.326] Synchronous encoder axis error No."

#### (2) Warning detection

"b5: Warning detection flag" of "[Md.325] Synchronous encoder axis status" for target axis turns ON, and the input axis warning number is stored in "[Md.327] Synchronous encoder axis warning No."

#### (3) Resetting errors and warnings

Remove the cause of error or warning following the actions described in Section 6.2.1 and 6.2.2, before canceling an error or warning state through resetting the error.

An error or warning state is canceled after the following processing is carried out by setting "1" in "[Cd.323] Synchronous encoder axis error reset" for target axis.



- " b4: Error detection flag" of "[Md.325] Synchronous encoder axis status" is turned OFF.
- "[Md.326] Synchronous encoder axis error No." is cleared.
- " b5: Warning detection flag" of "[Md.325] Synchronous encoder axis status" is turned OFF.
- "[Md.327] Synchronous encoder axis warning No." is cleared.

## 6.2.1 List of input axis errors

Error No.	Error name	Error	Operation status at error occurrence	Corrective action		
600 (258h)	Outside input axis type setting range	Setting values of input axis parameters "[Pr.300] Servo input axis type" and "[Pr.320] Synchronous encoder axis type" are outside the setting range.	The setting becomes invalid for input axis.	Set a value within the setting range.		
601 (259h)	Outside input axis unit setting range	Setting value of the input axis parameter "[Pr.321] Synchronous encoder axis unit setting" is outside the setting range.				
602 (25Ah)	Outside input axis unit conversion denominator range	The input axis parameter "[Pr.323] Synchronous encoder axis unit conversion: Denominator" is set to 0 or lower.				
603 (25Bh)	Outside input axis length per cycle range	The input axis parameter "[Pr.324] Synchronous encoder axis length per cycle" is set to 0 or lower.				
604 (25Ch)	Outside input axis smoothing time constant range	The input axis parameters "[Pr.301] Servo input axis smoothing time constant" and "[Pr.325] Synchronous encoder axis smoothing time constant" are set other than 0 to 5000.				
605 (25Dh)	Outside input axis rotation direction restriction setting range	The input axis parameters "[Pr.304] Servo input axis rotation direction restriction" and "[Pr.328] Synchronous encoder axis rotation direction restriction" are set other than 0 to 2.	The input axis operation is immediately stopped, and a connection becomes invalid.	Set a value within the range of 1 to 2147483647.		
608 (260h)	Input axis unit conversion overflow	Internal operation overflow occurred because the unit conversion ratio (unit conversion: Numerator / unit conversion: Denominator) of the input axis is too large.				
609 (261h)	Speed-position switching control start in servo input axis not possible	When the input axis parameter "[Pr.300] Servo input axis type" is feed current value or read current value, the speed-position switching control is started with the detailed parameter 1 "[Pr.21] Feed current value during speed control" set to other than "1:Update of feed current value".				
610 (262h)	Synchronous encoder via servo amplifier communication error QD77MS LD77MS QD77GF [CiA402 mode]	<ul style="list-style-type: none"> <li>The hardware of the synchronous encoder or the servo amplifier is faulty.</li> <li>The synchronous encoder cable is disconnected.</li> <li>Communication to the synchronous encoder cannot be established.</li> </ul>			The connection of synchronous encoder axis becomes invalid.	Set a value within the range of 0 to 5000.
						Set a value within the range of 0 to 2.
				<ul style="list-style-type: none"> <li>Set a smaller unit conversion ratio (unit conversion: Numerator / unit conversion: Denominator) of the input axis.</li> <li>Decrease the input axis speed.</li> </ul>		
				<ul style="list-style-type: none"> <li>Set "[Pr.300] Servo input axis type" to "Servo command value" or "Feedback value".</li> <li>Set "[Pr.21] Feed current value during speed control" to "1:Update of feed current value".</li> </ul>		
				<ul style="list-style-type: none"> <li>Replace the synchronous encoder or the servo amplifier.</li> <li>Check the synchronous encoder cable.</li> <li>Check the connected synchronous encoder.</li> <li>Check whether the synchronous encoder cable is faulty.</li> </ul>		

Error No.	Error name	Error	Operation status at error occurrence	Corrective action
611 (263h)	Synchronous encoder via servo amplifier battery error <span style="background-color: black; color: white; padding: 2px;">QD77MS</span> <span style="background-color: black; color: white; padding: 2px;">LD77MS</span> <span style="background-color: black; color: white; padding: 2px;">QD77GF</span> [CiA402 mode]	The battery which the servo amplifier connected synchronous encoder is empty or the battery is disconnected.	The synchronous encoder control continues.	Replace the battery or check the battery connection of the servo amplifier.
613 (265h)	Outside command generation axis length per cycle setting error <span style="background-color: black; color: white; padding: 2px;">QD77MS</span> <span style="background-color: black; color: white; padding: 2px;">LD77MS</span>	"[Pr.346] Command generation axis length per cycle" is outside the setting range of 0 to 2147483647.	"[Pr.346] Command generation axis length per cycle" operates regarded as the setting value "0".	Set a value within the range of 1 to 2147483647 for "[Pr.346] Command generation axis length per cycle"

## 6.2.2 List of input axis warnings

Warning No.	Warning name	Warning	Operation status at warning occurrence	Corrective action
680 (2A8h)	Input axis phase compensation amount over	Phase compensation amount of input axis is equal or lower than the minimum value (-2147483648), or exceeding the maximum value (2147483647).	The input axis operation continues. It is controlled with the minimum or maximum value.	<ul style="list-style-type: none"> <li>Set a smaller phase compensation advance time.</li> <li>Decrease the input axis speed.</li> </ul>
681 (2A9h)	Input axis rotation direction restriction amount over	Rotation direction restriction amount of input axis is equal or lower than the minimum value (-2147483648), or exceeding the maximum value (2147483647).		<ul style="list-style-type: none"> <li>Confirm the enabled direction of the rotation direction restriction setting. (The setting may be reversed.)</li> <li>Check if the input axis moves to the reverse direction of the enabled direction.</li> </ul>
682 (2AAh)	Input axis speed display over	Monitor speed display of input axis is equal or lower than the minimum value (-2147483648), or exceeding the maximum value (2147483647).	The input axis operation continues. The minimum or maximum value is displayed as the speed display of monitor data.	<ul style="list-style-type: none"> <li>Set a lower value if the number of decimal places for speed command setting is available in the input axis setting.</li> <li>Switch the units from minute to second if the speed command time unit setting is available in the input axis setting.</li> <li>Decrease the input axis speed.</li> </ul>
683 (2ABh)	Synchronous encoder via servo amplifier battery warning    [CiA402 mode]	Voltage of the servo amplifier battery connected with a synchronous encoder decreased to 3.2V or less.	The synchronous encoder control continues.	Replace the battery.

### 6.3 Error and warning of output axis

The detection processing and reset method for error and warning of output axis are similar to normal positioning control.

#### ■ Error and warning of output axis

##### (1) Error detection

The error detection signal turns ON, and the output axis error number is stored in "[Md.23] Axis error No."

##### (2) Warning detection

"b9: Axis warning detection" of "[Md.31] Status" turns ON, and the output axis warning number is stored in "[Md.24] Axis warning No."

##### (3) Resetting errors and warnings

Remove the cause of error or warning following the actions described in Section 6.3.1 and 6.3.2, before canceling an error or warning state through resetting the error.

An error or warning state is canceled after the following processing is carried out by setting "1" in "[Cd.5] Axis error reset" for target axis.

- Axis error detection signal is turned OFF
- "[Md.23] Axis error No." is cleared
- "[Md.24] Axis warning No." is cleared
- Changing of "[Md.26] Axis operation status" from "Error" to "Standby".
- "Axis warning detection ([Md.31] Status: b9)" is turned OFF

#### 6.3.1 List of output axis errors

Error No.	Error name	Error	Operation status at error occurrence	Corrective action
700 (2BCh)	Outside main input axis No. range	<ul style="list-style-type: none"> <li>• Setting value of the synchronous parameter "[Pr.400] Main input axis No." is outside the setting range.</li> <li>• The same servo input axis No. as the output axis is set in the synchronous parameter "[Pr.400] Main input axis No."</li> </ul>	Synchronous control does not start.	<ul style="list-style-type: none"> <li>• Set within the range.</li> <li>• Do not set up the same servo input axis number as the output axis.</li> </ul>
701 (2BDh)	Outside sub input axis No. range	<ul style="list-style-type: none"> <li>• Setting value of the synchronous parameter "[Pr.401] Sub input axis No." is outside the setting range.</li> <li>• The same servo input axis No. as the output axis is set in the synchronous parameter "[Pr.401] Sub input axis No."</li> </ul>		
702 (2BEh)	Outside main shaft gear: denominator range	The synchronous parameter "[Pr.404] Main shaft gear: Denominator" is set to 0 or lower.		Set a value within the range of 1 to 2147483647.
703 (2BFh)	Main shaft gear operation overflow	Overflow (sign reversion) occurred in input values, because the main shaft gear ratio is too large.	Synchronous control is immediately stopped.	<ul style="list-style-type: none"> <li>• Set a smaller absolute value for the synchronous parameter "[Pr.403] Main shaft gear: Numerator".</li> <li>• Set a larger value for the synchronous parameter "[Pr.404] Main shaft gear: Denominator".</li> <li>• Decrease the input axis speed.</li> </ul>

Error No.	Error name	Error	Operation status at error occurrence	Corrective action
704 (2C0h)	Outside main shaft clutch control setting range	Setting value of the synchronous parameter "[Pr.405] Main shaft clutch control setting" is outside the setting range.	Synchronous control does not start.	Set within the range.
705 (2C1h)	Outside main shaft clutch reference address setting range	Setting value of the synchronous parameter "[Pr.406] Main shaft clutch reference address setting" is outside the setting range.		
706 (2C2h)	Outside main shaft clutch smoothing method range	Setting value of the synchronous parameter "[Pr.411] Main shaft clutch smoothing method" is outside the setting range.		
707 (2C3h)	Outside main shaft clutch smoothing time constant range	Setting value of the synchronous parameter "[Pr.412] Main shaft clutch smoothing time constant" is outside the setting range.		
720 (2D0h)	Outside auxiliary shaft axis No. range	<ul style="list-style-type: none"> <li>• Setting value of the synchronous parameter "[Pr.418] Auxiliary shaft axis No." is outside the setting range.</li> <li>• The same servo input axis No. as the output axis is set in the synchronous parameter "[Pr.418] Auxiliary shaft axis No."</li> </ul>	Synchronous control does not start.	<ul style="list-style-type: none"> <li>• Set within the range.</li> <li>• Do not set the same servo input axis number of the output axis.</li> </ul>
722 (2D2h)	Outside auxiliary shaft gear: denominator range	The synchronous parameter "[Pr.421] Auxiliary shaft gear: Denominator" is set to 0 or lower.		Set a value within the range of 1 to 2147483647.
723 (2D3h)	Auxiliary shaft gear operation overflow	Overflow (sign reversion) occurred in input values, because the auxiliary shaft gear ratio is too large.	Synchronous control is immediately stopped.	<ul style="list-style-type: none"> <li>• Set a smaller absolute value for the synchronous parameter "[Pr.420] Auxiliary shaft gear: Numerator".</li> <li>• Set a larger value for the synchronous parameter "[Pr.421] Auxiliary shaft gear: Denominator".</li> <li>• Decrease the input axis speed.</li> </ul>
724 (2D4h)	Outside auxiliary shaft clutch control setting range	Setting value of the synchronous parameter "[Pr.422] Auxiliary shaft clutch control setting" is outside the setting range.	Synchronous control does not start.	Set within the range.
725 (2D5h)	Outside auxiliary shaft clutch reference address setting range	Setting value of the synchronous parameter "[Pr.423] Auxiliary shaft clutch reference address setting" is outside the setting range.		
726 (2D6h)	Outside auxiliary shaft clutch smoothing method range	Setting value of the synchronous parameter "[Pr.428] Auxiliary shaft clutch smoothing method" is outside the setting range.		
727 (2D7h)	Outside auxiliary shaft clutch smoothing time constant range	Setting value of the synchronous parameter "[Pr.429] Auxiliary shaft clutch smoothing time constant" is outside the setting range.		
740 (2E4h)	Outside speed change gear range	Setting value of the synchronous parameter "[Pr.434] Speed change gear" is outside the setting range.		

Error No.	Error name	Error	Operation status at error occurrence	Corrective action
741 (2E5h)	Outside speed change ratio denominator range	The synchronous parameter "[Pr.437] Speed change ratio: Denominator" is set to 0 or lower"	Synchronous control does not start.	Set a value within the range of 1 to 2147483647.
742 (2E6h)	Outside speed change gear smoothing time constant range	The synchronous parameter "[Pr.435] Speed change gear smoothing time constant" is set other than 0 to 5000.	Synchronous control does not start.	Set a value within the range of 0 to 5000.
743 (2E7h)	Speed change gear overflow	Overflow (sign reversion) occurred in input values, because the speed change ratio of speed change gear is too large.	Synchronous control is immediately stopped.	<ul style="list-style-type: none"> <li>Set a smaller absolute value for the synchronous parameter "[Pr.436] Speed change ratio: Numerator".</li> <li>Set a larger value for the synchronous parameter "[Pr.437] Speed change ratio: Denominator".</li> <li>Decrease the input axis speed.</li> </ul>
750 (2EEh)	Outside cam No. range	The synchronous parameter "[Pr.440] Cam No." is set to other than 0 to 256.	Synchronous control does not start.	Set a value within the range of 0 to 256.
751 (2EFh)	Cam not registered	Cam data specified in the synchronous parameter "[Pr.440] Cam No." does not exist on the cam open area.		Specify the cam No. of an existing cam data.
752 (2F0h)	Outside cam axis length per cycle range	The synchronous parameter "[Pr.439] Cam axis length per cycle" is set to 0 or lower.		Set a value within the range of 1 to 2147483647.
753 (2F1h)	Outside output axis smoothing time constant range	The synchronous parameter "[Pr.447] Output axis smoothing time constant" is set to other than 0 to 5000.		Set a value within the range of 0 to 5000.
760 (2F8h)	Outside setting method of current value per cycle after main shaft gear range	The synchronous parameter "[Pr.460] Setting method of current value per cycle after main shaft gear" is set to other than 0 to 2.		Set a value within the range of 0 to 2.
761 (2F9h)	Outside current value per cycle after main shaft gear (Initial setting) range	The synchronous parameter "[Pr.465] Current value per cycle after main shaft gear (Initial setting)" is other than 0 to (Cam axis length per cycle - 1).		Set within the range of 0 to (Cam axis length per cycle - 1).
762 (2FAh)	Outside setting method of current value per cycle after auxiliary shaft gear range	The synchronous parameter "[Pr.461] Setting method of current value per cycle after auxiliary shaft gear" is set to other than 0 to 2.		Set a value within the range of 0 to 2.
763 (2FBh)	Outside current value per cycle after auxiliary shaft gear (Initial setting) range	The synchronous parameter "[Pr.466] Current value per cycle after auxiliary shaft gear (Initial setting)" is other than 0 to (Cam axis length per cycle - 1).		Set within the range of 0 to (Cam axis length per cycle - 1).
764 (2FCh)	Outside cam axis position restoration object range	The synchronous parameter "[Pr.462] Cam axis position restoration object" is set to other than 0 to 2.		Set a value within the range of 0 to 2.
765 (2FDh)	Outside setting method of cam reference position range	The synchronous parameter "[Pr.463] Setting method of cam reference position " is set to other than 0 to 2.		
766 (2FEh)	Outside setting method of cam axis current value per cycle range	<ul style="list-style-type: none"> <li>The synchronous parameter "[Pr.464] Setting method of cam axis current value per cycle" is set to other than 0 to 3.</li> <li>"3: Current value per cycle after auxiliary shaft gear" is established when the auxiliary shaft does not exist.</li> </ul>	<ul style="list-style-type: none"> <li>Set a value within the range of 0 to 3.</li> <li>Set other than "3: Current value per cycle after auxiliary shaft gear" when the auxiliary shaft does not exist.</li> </ul>	

Error No.	Error name	Error	Operation status at error occurrence	Corrective action
767 (2FFh)	Outside cam axis current value per cycle (Initial setting) range	The synchronous parameter "[Pr.468] Cam axis current value per cycle (Initial setting)" is set other than 0 to (Cam axis length per cycle - 1).	Synchronous control does not start.	Set within the range of 0 to (Cam axis length per cycle - 1).
768 (300h)	Cam axis current value per cycle restoration disable	Cam axis current value per cycle corresponding to the feed current value at synchronous control start could not be restored when the synchronous parameter "[Pr.462] Cam axis position restoration object" was "0: Cam axis current value per cycle restoration". (Occurs in reciprocated cam pattern)		<ul style="list-style-type: none"> <li>• Start synchronous control after moving the feed current value as to fit within the stroke of two-way operation cam pattern.</li> <li>• Set the cam reference position as to fit within the stroke of two-way operation cam pattern.</li> </ul>
769 (301h)	Cam axis feed current value restoration disable	Restoration could not be completed when the synchronous parameter "[Pr.462] Cam axis position restoration object" was "2: Cam axis feed current value restoration", because the difference between the restored cam axis feed current value and the feed current value at synchronous control start (pulse command unit) was larger than the servo parameter "In-position range".		<ul style="list-style-type: none"> <li>• Start synchronous control after calculating the cam axis feed current value to be restored, using the cam position calculation function, and moving the feed current value.</li> <li>• Set a larger setting value for the servo parameter "In-position range", if the current value is extremely small (such as 0).</li> </ul>



## 6.3.2 List of output axis warnings

Warning No.	Warning name	Warning	Operation status at warning occurrence	Corrective action
704 (2C0h)	Outside main shaft clutch control setting range	<ul style="list-style-type: none"> <li>The synchronous parameter "[Pr.405] Main shaft clutch control setting" was set to outside the setting range during the synchronous control.</li> <li>The synchronous parameter "[Pr.405] Main shaft clutch control setting" was set from a setting other than "No Clutch" to "No Clutch" during the synchronous control.</li> </ul>	Synchronous control continues by the previous main shaft clutch control setting.	<ul style="list-style-type: none"> <li>Set a value within the range.</li> <li>Do not change the settings other than "No Clutch" to "No Clutch".</li> </ul>
724 (2D4h)	Outside auxiliary shaft clutch control setting range	<ul style="list-style-type: none"> <li>The synchronous parameter "[Pr.422] Auxiliary shaft clutch control setting" was set to outside the setting range during the synchronous control.</li> <li>The synchronous parameter "[Pr.422] Auxiliary shaft clutch control setting" was set from a setting other than "No Clutch" to "No Clutch" during the synchronous control.</li> </ul>	Synchronous control continues by the previous auxiliary shaft clutch control setting.	
741 (2E5h)	Outside speed change ratio denominator range	The synchronous parameter "[Pr.437] Speed change ratio: Denominator" is set to 0 or lower during synchronous control.	Synchronous control continues by the previous speed change ratio (Denominator).	Set a value within the range of 1 to 2147483647.
750 (2EEh)	Outside cam No. range	The synchronous parameter "[Pr.440] Cam No." is set to other than 0 to 256 during synchronous control.		Set a value within the range of 0 to 256.
751 (2EFh)	Cam not registered	When changing the synchronous parameter "[Pr.440] Cam No.", the cam data of the changed cam No. does not exist on the Cam open area during synchronous control.	Synchronous control continues by the previous cam No.	Specify the cam No. of an existing cam data.
754 (2F2h)	Cam axis phase compensation amount over	Phase compensation amount of cam axis is equal or lower than the minimum value (-2147483648), or exceeding the maximum value (2147483647).	Synchronous control continues. The operation is controlled with the minimum or maximum value.	<ul style="list-style-type: none"> <li>Set a smaller cam axis phase compensation advance time.</li> <li>Decrease the cam axis input value speed.</li> </ul>

## 6.4 Warning of cam operation

A warning is detected for an axis 1 when in the cam operation (cam data operation/cam auto-generation/cam position calculation) is incorrect.

### ■ Warning of cam operation

#### (1) Warning detection

"b9: Axis warning detection of "[Md.31] Status" for axis 1 " turns ON, and the cam data operation warning number/cam auto-generation warning number/cam position calculation warning number is stored in "[Md.24] Axis warning No."

#### (2) Resetting warnings

Remove the cause of warning following the actions described in Section 6.4.1, 6.4.2 and 6.4.3, before canceling a warning state through resetting the error of axis 1.

A warning state is canceled after the following processing is carried out by setting "1" in "[Cd.5] Axis error reset" for axis 1.

- Axis error detection signal is turned OFF
- "[Md.23] Axis error No." is cleared
- "[Md.24] Axis warning No." is cleared
- Changing of "[Md.26] Axis operation status" from "Error" to "Standby".
- "Axis warning detection ([Md.31] Status: b9)" is turned OFF

#### POINT

A warning of cam operation occurs for an axis 1 without any condition. Judge whether it was completed normally by confirming a warning state of axis after the completion of cam operation.

### 6.4.1 List of cam data operation warnings

Warning No.	Warning name	Warning	Operation status at warning occurrence	Corrective action
810 (32Ah)	Outside operation cam No. range	"[Cd.601] Operation cam No." is other than 1 to 256.	Cam data writing/reading is not executed.	Set a value within the range of 1 to 256.
811 (32Bh)	Read cam not registered	Cam data of the specified cam No. does not exist on the cam open area during the cam data reading operation.		<ul style="list-style-type: none"> <li>• Specify the cam No. of an existing cam data.</li> <li>• When writing the cam data from a programming tool, turn the PLC ready signal from OFF to ON and open the cam data on the cam open area.</li> </ul>
812 (32Ch)	Outside cam data first position range	<ul style="list-style-type: none"> <li>• "[Cd.602] Cam data first position" is outside the range of "1 to Cam resolution" for the stroke ratio data format cam.</li> <li>• "[Cd.602] Cam data first position" is outside the range of "0 to (Coordinate number - 1)" for the coordinate data format cam.</li> </ul>		<ul style="list-style-type: none"> <li>• Set a value within the range of "1 to Cam resolution" for the stroke ratio data format cam.</li> <li>• Set a value within the range of "0 to (Coordinate number - 1)" for the coordinate data format cam.</li> </ul>

Warning No.	Warning name	Warning	Operation status at warning occurrence	Corrective action
813 (32Dh)	Outside number of cam data operation points range	<ul style="list-style-type: none"> <li>• "[Cd.603] Number of cam data operation points" is outside the range of 1 to 4096 for the stroke ratio data format cam.</li> <li>• "[Cd.603] Number of cam data operation points" is outside the range of 1 to 2048 for the coordinate data format cam.</li> <li>• First position and number of operation points which exceed the cam resolution or coordinate number are set during the cam data writing operation.</li> </ul>	Cam data writing/reading is not executed.	<ul style="list-style-type: none"> <li>• Set a value within the range of 1 to 4096 for the stroke ratio data format cam.</li> <li>• Set a value within the range of 1 to 2048 for the coordinate data format cam.</li> <li>• Set "Cam data first position + (Number of cam data operation points - 1)" not to exceed the cam resolution.</li> <li>• Set "Cam data first position + (Number of cam data operation points - 1)" not to exceed the number of coordinates.</li> </ul>
814 (32Eh)	Outside cam data format range	"[Cd.604] Cam data format" is other than 1 or 2 during the cam data writing operation.		Set 1 or 2.cam during
815 (32Fh)	Outside cam resolution/coordinate number range	<ul style="list-style-type: none"> <li>• "[Cd.605] Cam resolution/coordinate number" is other than "256/512/1024/2048/4096/8192/16384/32768" for the stroke ratio data format cam during the cam data writing operation.</li> <li>• "[Cd.605] Cam resolution/coordinate number" is outside the range of "2 to 16384" for the coordinate data format cam during the cam data writing operation.</li> </ul>		<ul style="list-style-type: none"> <li>• Set a value within the range of "256/512/1024/2048/4096/8192/16384 /32768" for the stroke ratio data format cam.</li> <li>• Set a value within the range of 2 to 16384 for the coordinate data format cam.</li> </ul>
816 (330h)	Outside cam data starting position range	"[Cd.606] Cam data starting point" is outside the range of "0 to (Cam resolution - 1)" during the cam data writing operation.		Set a value within the range of "0 to (Cam resolution - 1)".
817 (331h)	Cam storage area capacity over	<ul style="list-style-type: none"> <li>• The free area in the cam storage area is insufficient during the cam data writing operation.</li> <li>• The writable area is insufficient due to the decoupling of free area.</li> </ul>		<ul style="list-style-type: none"> <li>• Decrease the number of cam data (number of cams, cam resolution, and coordinate number).</li> <li>• Erase the cam data and rewrite it.</li> </ul>
818 (332h)	Cam open area capacity over	<ul style="list-style-type: none"> <li>• The free area in the cam open area is insufficient during the cam data writing operation.</li> <li>• The writable area is insufficient due to the decoupling of free area.</li> </ul>		
819 (333h)	Coordinate data error	<ul style="list-style-type: none"> <li>• Input value of coordinate data is a negative value during the cam data writing operation.</li> <li>• Input value of coordinate data is not "<math>X_n &lt; X_{n+1}</math>" during the cam data writing operation.</li> </ul>		<ul style="list-style-type: none"> <li>• Set the Input value of coordinate data to 0 or more.</li> <li>• Set the Input value of coordinate data to "<math>X_n &lt; X_{n+1}</math>".</li> </ul>
827 (33Bh)	Cam data reading operation inhibit	Cam data reading operation is executed with the cam data read password set.		Delete the cam data read password with a programming tool.
828 (33Ch)	Cam data writing operation inhibit	Cam data writing operation is executed with the cam data write password set.		Delete the cam data write password with a programming tool.

## 6.4.2 List of cam auto-generation warnings

Warning No.	Warning name	Warning	Operation status at warning occurrence	Corrective action
820 (334h)	Outside cam auto-generation cam No. range	"[Cd.609] Cam auto-generation cam No." is outside the range of 1 to 256.	Cam auto-generation is not executed.	Set a value within the range of 1 to 256.
821 (335h)	Outside cam auto-generation type range	"[Cd.610] Cam auto-generation type" is other than 1.		Set 1.
822 (336h)	Cam auto-generation cam storage area capacity over	<ul style="list-style-type: none"> <li>The free area in the cam storage area is insufficient.</li> <li>The writable area is insufficient due to the decoupling of free area.</li> </ul>		<ul style="list-style-type: none"> <li>Decrease the number of cam data (number of cams, cam resolution, and coordinate number).</li> <li>Erase the cam data and rewrite it.</li> </ul>
823 (337h)	Cam auto-generation cam open area capacity over	<ul style="list-style-type: none"> <li>The free area in the cam open area is insufficient.</li> <li>The writable area is insufficient due to the decoupling of free area.</li> </ul>		
824 (338h)	Outside cam auto-generation data range	"[Cd.611] Cam auto-generation data" is outside the setting range.		Set a value within the setting range for the cam auto-generation.
825 (339h)	Cam auto-generation calculation disable	"[Cd.611] Cam auto-generation data" is set to the value that the cam pattern cannot be generated. (Such as when the sheet synchronization width is larger than the sheet length in the cam for a rotary cutter)		Review the setting value of the cam auto-generation data.
826 (33Ah)	Cam auto-generation data write inhibit	Cam auto-generation is executed with the cam data write password set.		Delete the cam data write password with a programming tool.

## 6.4.3 List of cam position calculation warnings

Warning No.	Warning name	Warning	Operation status at warning occurrence	Corrective action
830 (33Eh)	Outside cam position calculation cam No. range	"[Cd.613] Cam position calculation: Cam No." is outside the range of 0 to 256.	Cam position calculation is not executed.	Set a value within the range of 0 to 256.
831 (33Fh)	Cam position calculation cam not registered	Cam data of the specified cam No. does not exist on the cam open area during the cam position calculation.		<ul style="list-style-type: none"> <li>• Specify the cam No. of an existing cam data.</li> <li>• When writing the cam data from a peripheral software, turn the PLC ready signal from OFF to ON and open the cam data ON the cam open area.</li> </ul>
832 (340h)	Outside cam position calculation cam axis length per cycle range	"[Cd.615] Cam position calculation: Cam axis length per cycle" is set to 0 or lower.		Set a value within the range of 1 to 2147483647.
833 (341h)	Outside cam position calculation cam axis current value per cycle range	"[Cd.617] Cam position calculation: Cam axis current value per cycle" is outside the range of 0 to "Cam axis length per cycle".		Set a value within the range of 0 to "Cam axis length per cycle".
834 (342h)	Cam position calculation cam axis 1 cycle current value calculation disable	Corresponding cam axis current value per cycle could not be calculated during cam axis current value per cycle calculation. (Occurs in reciprocated cam pattern)		Set "[Cd.614] Cam position calculation: Stroke amount", "[Cd.616] Cam position calculation: Cam reference position", and "[Cd.618] Cam position calculation: Cam axis feed current value" within the range of reciprocated cam pattern stroke.



# Appendices

Appendix 1 Comparisons with the Motion controller SV22.....Appendix- 2  
Appendix 2 Sample program of synchronous control .....Appendix- 6  
Appendix 3 Lists of buffer memory addresses for synchronous control .....Appendix-10

Appendix 1 Comparisons with the Motion controller SV22

The following shows the differences in synchronous control functions between the Motion controller Q172DCPU (SV22) and Simple Motion module QD77MS/QD77GF/LD77MS/LD77MH.

Item		Q172DCPU	QD77MS/QD77GF/LD77MS/LD77MH
General	Starting method	The whole system is switched to the virtual mode by turning ON the real/virtual mode switching request bit.	The control is started for each axis by turning ON the synchronous control start bit for each axis.
	Stopping method	The whole system is switched to the real mode by turning OFF the real/virtual mode switching request bit.	The control is stopped for each axis by turning OFF the synchronous control start bit of each axis.
Drive module	Number of settings per output axis	Total 3 axes of main shaft (2 axes) and auxiliary input (1 axis)	Total 3 axes of main shaft (2 axes) and auxiliary input (1 axis)
	Virtual servo motor axis	8 axes Command unit: PLS	None (It can be substituted by the servo input axis setting to the virtual servo amplifier.)
	Servo input axis	None	Use the servo amplifier as the drive module (input axis). (It is possible to use without connecting the servo amplifier by setting to the virtual servo amplifier.) Command units: mm, inch, degree, PLS
	Synchronous encoder axis	Incremental/Absolute synchronous encoder (8 axes) Input speed (Q173DPX): 200kPLS/s Command unit: PLS	Incremental/Via servo amplifier/Via CPU synchronous encoder (4 axes) 1) Incremental synchronous encoder 1 connectable axis with a built-in module Input speed: 4MPLS/s 2) Synchronous encoder via servo amplifier Up to 4 connectable axes via the servo amplifier 3) Synchronous encoder via CPU Up to 4 connectable axes via the PLC CPU Command units: mm, inch, degree, PLS The current value per cycle: Provided Smoothing: Provided Phase compensation: Provided Rotation direction restriction: Provided



Item		Q172DCPU	QD77MS/QD77GF/LD77MS/LD77MH
Transmission module	Gear	Number of input side teeth: 1 to 65535 Number of output side teeth: 1 to 65535 Rotation direction: Forward/Reverse	Numerator of gear: -2147483648 to 2147483647 Denominator of gear: 1 to 2147483647 Rotation direction: Set by a sign of the numerator of gear
	Clutch <sup>(Note)</sup>	Clutch mode: ON/OFF, Address 1, Address 2, One-shot, External input Smoothing: Time constant (Exponential system), Slippage amount (Exponential system / Linear system)	Clutch mode: Clutch command ON/OFF, Clutch command leading edge, Clutch command trailing edge, One-shot OFF, Address mode, High speed input request. (Set mode for ON condition and OFF condition individually.) Smoothing: Time constant (Exponential system / Linear system), Slippage (Exponential system / Linear system)
	Speed change gear	Speed change ratio: 0 to 655.35% Smoothing: Exponential system	Numerator of speed change ratio: -2147483648 to 2147483647 Denominator of speed change ratio: 1 to 2147483647 Smoothing: Linear system
	Differential gear	Use main shaft and auxiliary input. (Main shaft side: +, Auxiliary shaft side: -)	Use composite main shaft gear and composite auxiliary shaft gear. (Select a composite method for each input from "Input+/Input-/No input (0)".)

(Note): Clutch compatibility

The following shows the control methods for the clutch setting in the Simple Motion module QD77MS/QD77GF/LD77MS/LD77MH compared with those in the Motion controller Q173DCPU/Q172DCPU (SV22).

Q173DCPU/Q172DCPU (SV22)	QD77MS/QD77GF/LD77MS/LD77MH	
Clutch mode	ON control mode	OFF control mode
ON/OFF mode	1: Clutch command ON/OFF	—
Address mode	4: Address mode	4: Address mode
One-shot mode	2: Clutch command leading edge	1: One-shot OFF
External input mode	5: High speed input request	3: Clutch command trailing edge

Item		Q172DCPU	QD77MS/QD77GF/LD77MS/LD77MH
Output module	Type	Roller shaft, Ball screw shaft, Rotary table shaft, Cam shaft (It is impossible to use "degree" as the unit of cam shaft.)	Cam shaft only. (The linear cam can be controlled as same as the ball screw shaft etc. It is possible to use as "degree" the unit of cam shaft.)
	Phase compensation	Advance time: -2147483648 to 2147483647 $\mu$ s Time constant: 0 to 32767 [Number of operation cycle]	Advance time: -2147483648 to 2147483647 $\mu$ s Time constant: 0 to 65535 ms
	Stroke limit operation	An error is detected by stroke limit. However, the operation is continued.	An error is detected by stroke limit and the operation is stopped.
	Stop command	Invalid	Valid
	Cam/ball screw switching	Provided (Operate the ball screw by inputting the command pulse from the drive axis.)	None (Operate the ball screw by the positioning control after the synchronous control stop of each axis.)
	Cam axis starting point	1) Cam reference position setting ON: Start from the point corresponding to "current value within 1 cam shaft revolution is 0". 2) Cam reference position setting OFF: Restore the current value within 1 cam shaft revolution based on the feed current value.	Select the one which is restored, from "cam axis current value per cycle", "cam reference position" or "cam axis feed current value", in the parameter. (The initial setting is same as 1) in Q172DCPU.)

Item		Q172DCPU	QD77MS/QD77GF/LD77MS/LD77MH
Cam function	Cam resolution/ Number of coordinate	Cam resolution: 256, 512, 1024, 2048 (Coordinate data format: None)	Stroke ratio data format: 256, 512, 1024, 2048, 4096, 8192, 16384, 32768 Coordinate data format: 2 to 16384
	Number of cam	Up to 256	Up to 256
	Cam No.	1 to 64, 101 to 164, 201 to 264, 301 to 364	0 to 256 (0: Linear cam)
	Stroke ratio	0 to 32767 (32767: 100%)	-214.7483648 to 214.7483647%
	Cam mode	Two-way cam mode (Endpoint: 0% fixed) Feed cam mode (Endpoint: 100% fixed)	None (No restrictions by a cam mode due to the possibility of freely setting the endpoint.)
	Editing method of cam data	Programming software: MT Developer, MT Works2 Motion SFC program: BMOV command (New pattern cannot be added.)	Programming software: GX Works2 Sequence program: Cam data operation by buffer memory. (New pattern can be added.)
	Cam auto- generation	None	Cam pattern for rotary cutter can be generated automatically.
	Cam position calculation	None	Cam axis feed current value and cam axis current value per cycle can be calculated before starting synchronous control.
Others	Mixed function of virtual mode/real mode	Provided	None (Synchronous control can be started and stopped for each axis.)
	Operation status at servo alarm occurrence	It is possible to select to continue the virtual mode at a servo alarm occurrence. (All relevant systems stop even if a continuance is selected.)	No effect on axis operations except the axes where a servo alarm has occurred. (Use the user program to stop axes where a servo alarm has not occurred.)

Appendix 2 Sample program of synchronous control

The following shows a sample program of executing synchronous control on the axis 1 with the axis 4 as an input axis. (The axis 4 is configured as the virtual servo amplifier.)

- 1) Set MR-J4(W)-B(-RJ) on the axis 1 and the virtual servo amplifier on the axis 4 in the system setting.

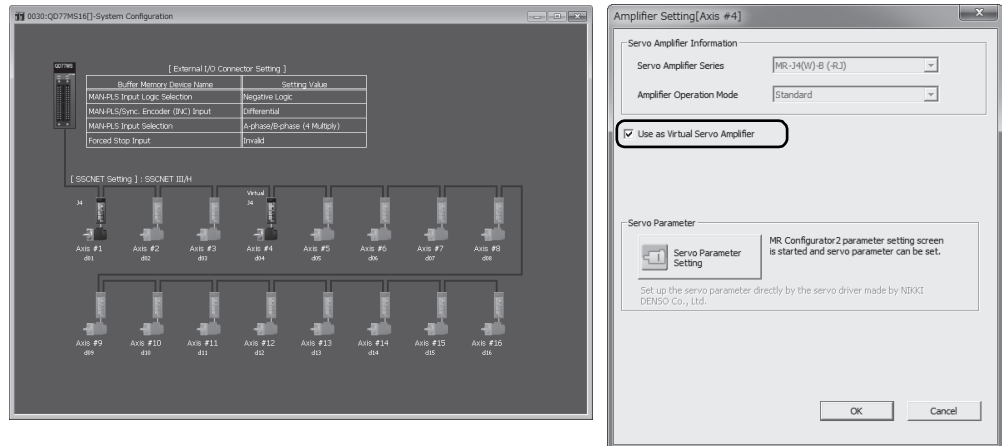

- 2) Set the axis 4 as the servo input axis in the input axis parameter.

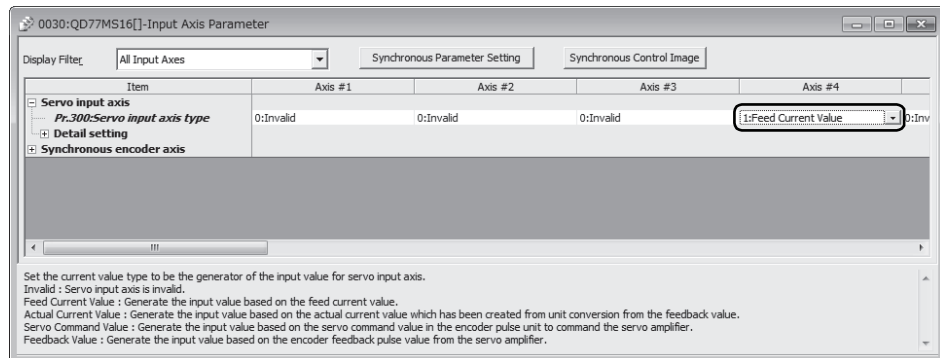

3) Create the cam data (cam No.1).

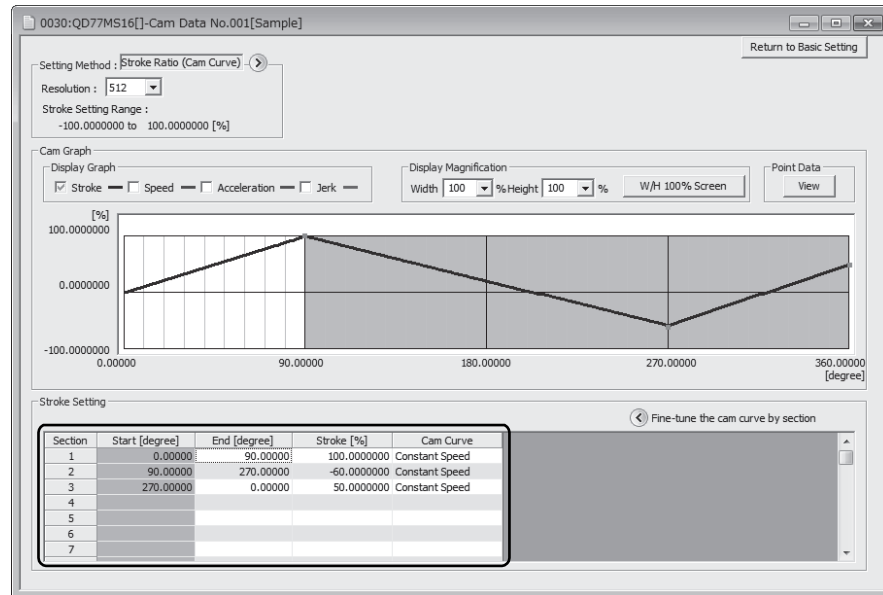

4) Set the synchronous parameter of the axis 1.

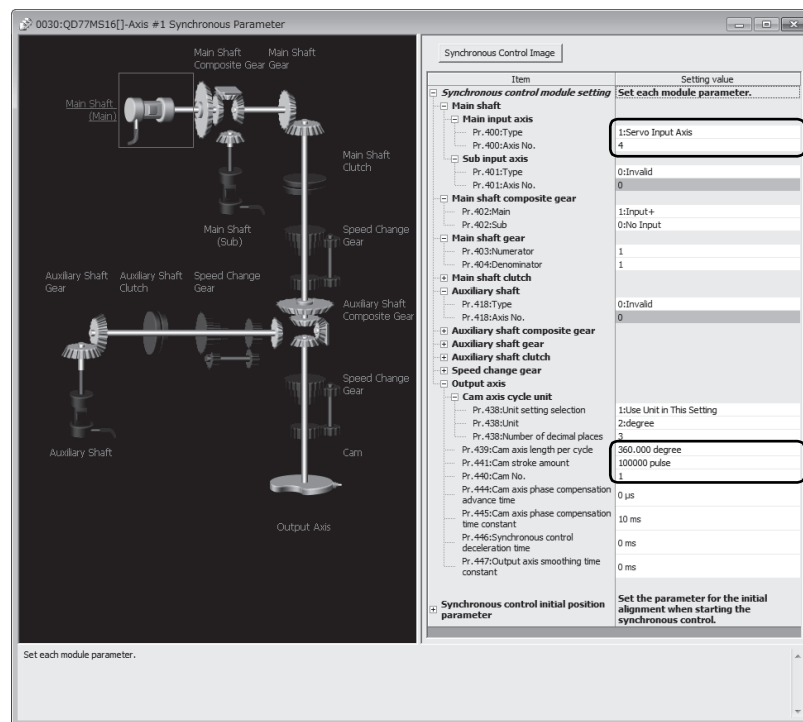

5) Create the program to start synchronous control.

The sample programs when head I/O number of the Simple Motion module is set to "30H" are shown below.

[Operation example for 4-axis module]

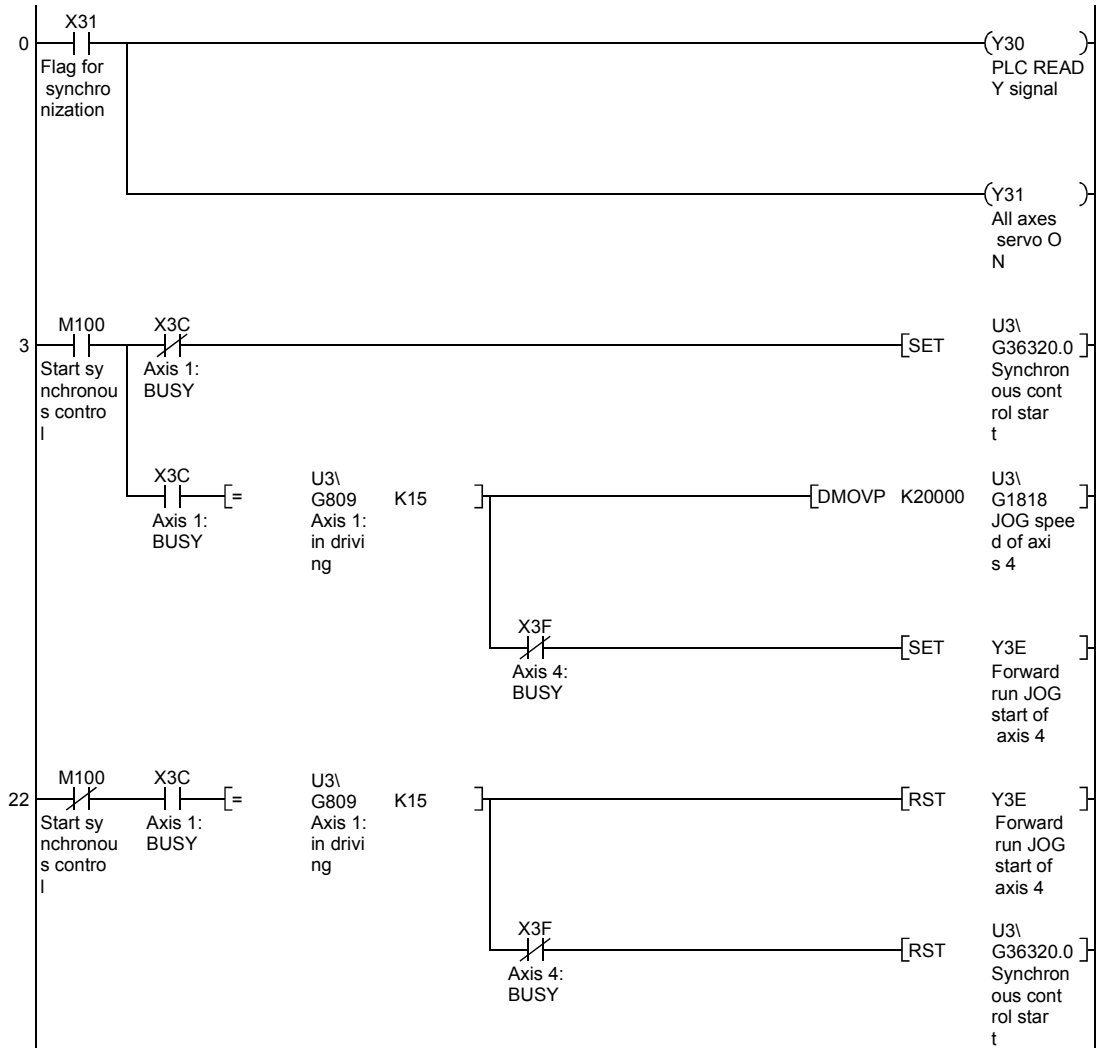

[Operation example for 16-axis module]

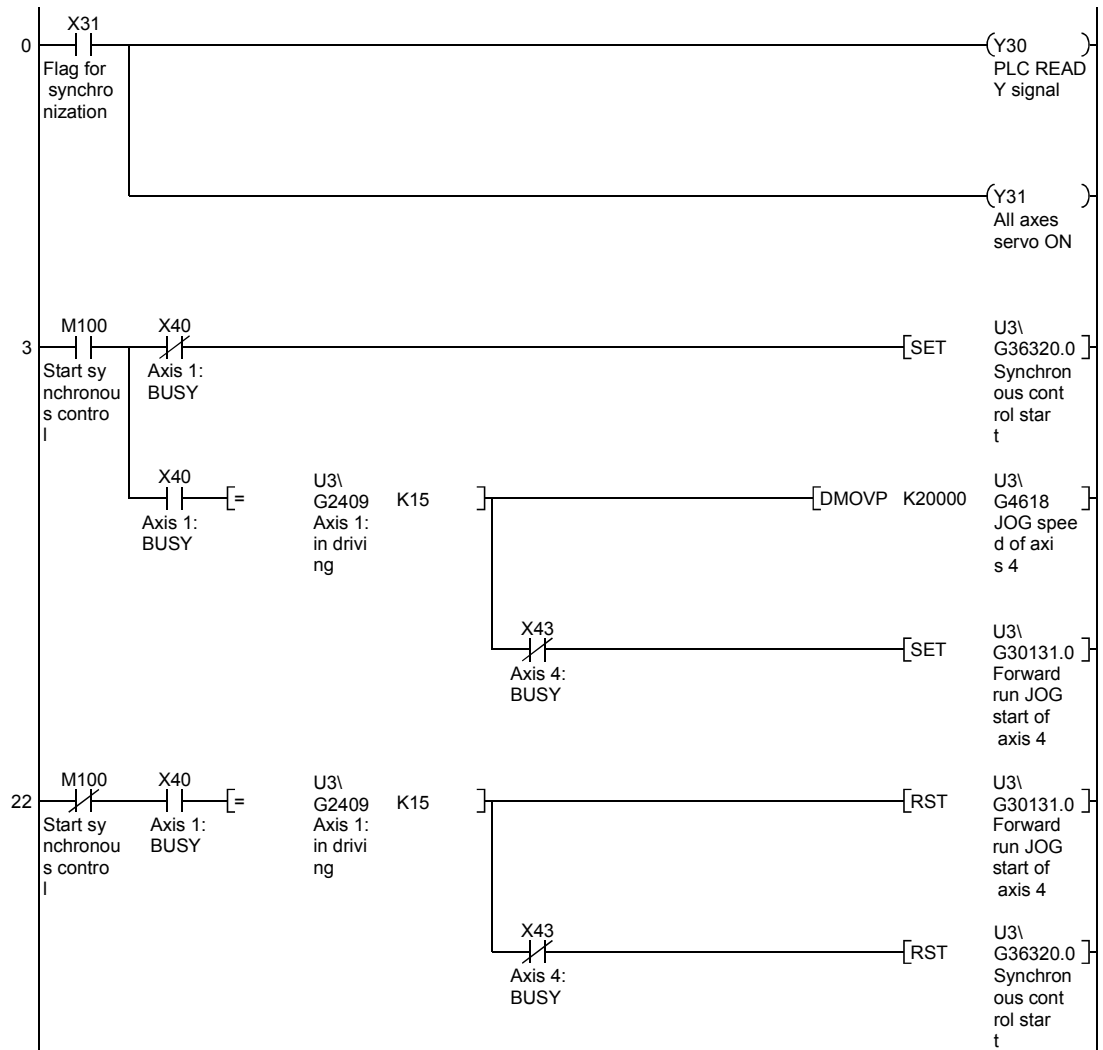

Appendix 3 Lists of buffer memory addresses for synchronous control

Refer to "User's Manual (Positioning Control)" of each Simple Motion module for the list of general buffer memory addresses.

(1) Synchronous control system control data

Item		Buffer memory address	Reference section
[Cd.380]	Synchronous control start	36320	Section 1.4.2
[Cd.381]	Synchronous control analysis mode	36322	Section 5.4

(2) Servo input axis parameter

Item		Buffer memory address	Reference section
[Pr.300]	Servo input axis type	32800+10n	Section 2.1.2
[Pr.301]	Servo input axis smoothing time constant	32801+10n	
[Pr.302]	Servo input axis phase compensation advance time	32802+10n 32803+10n	
[Pr.303]	Servo input axis phase compensation time constant	32804+10n	
[Pr.304]	Servo input axis rotation direction restriction	32805+10n	

n: Axis No.-1

(3) Servo input axis monitor data

Item		Buffer memory address	Reference section
[Md.300]	Servo input axis current value	33120+10n 33121+10n	Section 2.1.3
[Md.301]	Servo input axis speed	33122+10n 33123+10n	
[Md.302]	Servo input axis phase compensation amount	33124+10n 33125+10n	
[Md.303]	Servo input axis rotation direction restriction amount	33126+10n 33127+10n	

n: Axis No.-1



(4) Synchronous encoder axis parameter

Item		Buffer memory address	Reference section
[Pr.320]	Synchronous encoder axis type	34720+20j	Section 2.3.3
[Pr.321]	Synchronous encoder axis unit setting	34721+20j	
[Pr.322]	Synchronous encoder axis unit conversion: Numerator	34722+20j 34723+20j	
[Pr.323]	Synchronous encoder axis unit conversion: Denominator	34724+20j 34725+20j	
[Pr.324]	Synchronous encoder axis length per cycle	34726+20j 34727+20j	
[Pr.325]	Synchronous encoder axis smoothing time constant	34728+20j	
[Pr.326]	Synchronous encoder axis phase compensation advance time	34730+20j 34731+20j	
[Pr.327]	Synchronous encoder axis phase compensation time constant	34732+20j	
[Pr.328]	Synchronous encoder axis rotation direction restriction	34733+20j	
[Pr.329]	Resolution of synchronous encoder via CPU	34734+20j 34735+20j	

j: Synchronous encoder axis No.-1

(5) Synchronous encoder axis control data

Item		Buffer memory address	Reference section
[Cd.320]	Synchronous encoder axis control start	35040+10j	Section 2.3.4
[Cd.321]	Synchronous encoder axis control method	35041+10j	
[Cd.322]	Synchronous encoder axis current value setting address	35042+10j 35043+10j	
[Cd.323]	Synchronous encoder axis error reset	35044+10j	
[Cd.324]	Connection command of synchronous encoder via CPU	35045+10j	
[Cd.325]	Input value for synchronous encoder via CPU	35046+10j 35047+10j	

j: Synchronous encoder axis No.-1

(6) Synchronous encoder axis monitor data

Item		Buffer memory address	Reference section
[Md.320]	Synchronous encoder axis current value	35200+20j 35201+20j	Section 2.3.5
[Md.321]	Synchronous encoder axis current value per cycle	35202+20j 35203+20j	
[Md.322]	Synchronous encoder axis speed	35204+20j 35205+20j	
[Md.323]	Synchronous encoder axis phase compensation amount	35206+20j 35207+20j	
[Md.324]	Synchronous encoder axis rotation direction restriction amount	35208+20j 35209+20j	
[Md.325]	Synchronous encoder axis status	35210+20j	
[Md.326]	Synchronous encoder axis error No.	35211+20j	
[Md.327]	Synchronous encoder axis warning No.	35212+20j	

j: Synchronous encoder axis No.-1

(7) Synchronous parameter

Item		Buffer memory address	Reference section	
[Pr.400]	Main shaft	Main input axis No.	Section 4.1.2	
[Pr.401]		Sub input axis No.		
[Pr.402]		Composite main shaft gear		
[Pr.403]		Main shaft gear: Numerator		36404+200n 36405+200n
[Pr.404]		Main shaft gear: Denominator		36406+200n 36407+200n

n: Axis No.-1

Item		Buffer memory address	Reference section		
[Pr.405]	Main shaft	Main shaft clutch control setting	Section 4.1.3		
[Pr.406]		Main shaft clutch reference address setting			
[Pr.407]		Main shaft clutch ON address			
[Pr.408]		Travel value before main shaft clutch ON			
[Pr.409]		Main shaft clutch OFF address			
[Pr.410]		Travel value before main shaft clutch OFF			
[Pr.411]		Main shaft clutch smoothing method			
[Pr.412]		Main shaft clutch smoothing time constant			
[Pr.413]		Slippage amount at main shaft clutch ON			
[Pr.414]		Slippage amount at main shaft clutch OFF			
[Pr.418]		Auxiliary shaft		Auxiliary shaft axis No.	Section 4.2.2
[Pr.419]				Composite auxiliary shaft gear	
[Pr.420]	Auxiliary shaft gear: Numerator				
[Pr.421]	Auxiliary shaft gear: Denominator				
[Pr.422]	Auxiliary shaft clutch control setting				
[Pr.423]	Auxiliary shaft clutch reference address setting		Section 4.2.3		
[Pr.424]	Auxiliary shaft clutch ON address				
[Pr.425]	Travel value before auxiliary shaft clutch ON				
[Pr.426]	Auxiliary shaft clutch OFF address				
[Pr.427]	Travel value before auxiliary shaft clutch OFF				
[Pr.428]	Auxiliary shaft clutch smoothing method				
[Pr.429]	Auxiliary shaft clutch smoothing time constant				
[Pr.430]	Slippage amount at auxiliary shaft clutch ON				
[Pr.431]	Slippage amount at auxiliary shaft clutch OFF				

n: Axis No.-1

		Item	Buffer memory address	Reference section
[Pr.434]	Speed change gear	Speed change gear	36460+200n	Section 4.4.2
[Pr.435]		Speed change gear smoothing time constant	36461+200n	
[Pr.436]		Speed change ratio: Numerator	36462+200n 36463+200n	
[Pr.437]		Speed change ratio: Denominator	36464+200n 36465+200n	
[Pr.438]	Output axis	Cam axis cycle unit setting	36470+200n	Section 4.5.2
[Pr.439]		Cam axis length per cycle	36472+200n 36473+200n	
[Pr.440]		Cam No.	36474+200n	
[Pr.441]		Cam stroke amount	36476+200n 36477+200n	
[Pr.444]		Cam axis phase compensation advance time	36482+200n 36483+200n	
[Pr.445]		Cam axis phase compensation time constant	36484+200n	
[Pr.446]		Synchronous control deceleration time	36485+200n	
[Pr.447]		Output axis smoothing time constant	36486+200n	
[Pr.460]	Synchronous control initial position	Setting method of current value per cycle after main shaft gear	36500+200n	Section 5.2
[Pr.461]		Setting method of current value per cycle after auxiliary shaft gear	36501+200n	
[Pr.462]		Cam axis position restoration object	36502+200n	
[Pr.463]		Setting method of cam reference position	36503+200n	
[Pr.464]		Setting method of cam axis current value per cycle	36504+200n	
[Pr.465]		Current value per cycle after main shaft gear (Initial setting)	36506+200n 36507+200n	
[Pr.466]		Current value per cycle after auxiliary shaft gear (Initial setting)	36508+200n 36509+200n	
[Pr.467]		Cam reference position (Initial setting)	36510+200n 36511+200n	
[Pr.468]	Cam axis current value per cycle (Initial setting)	36512+200n 36513+200n		

n: Axis No.-1

(8) Control data for synchronous control

Item		Buffer memory address	Reference section
[Cd.400]	Main shaft clutch command	44080+20n	Section 4.1.4
[Cd.401]	Main shaft clutch control invalid command	44081+20n	
[Cd.402]	Main shaft clutch forced OFF command	44082+20n	
[Cd.403]	Auxiliary shaft clutch command	44083+20n	Section 4.2.4
[Cd.404]	Auxiliary shaft clutch control invalid command	44084+20n	
[Cd.405]	Auxiliary shaft clutch forced OFF command	44085+20n	
[Cd.406]	Synchronous control change request	44086+20n	Section 4.6.2
[Cd.407]	Synchronous control change command	44087+20n	
[Cd.408]	Synchronous control change value	44088+20n 44089+20n	
[Cd.409]	Synchronous control reflection time	44090+20n	

n: Axis No.-1

(9) Synchronous control monitor data

Item		Buffer memory address	Reference section
[Md.400]	Current value after composite main shaft gear	42800+40n 42801+40n	Section 4.7
[Md.401]	Current value per cycle after main shaft gear	42802+40n 42803+40n	
[Md.402]	Current value per cycle after auxiliary shaft gear	42804+40n 42805+40n	
[Md.406]	Cam axis phase compensation amount	42810+40n 42811+40n	
[Md.407]	Cam axis current value per cycle	42812+40n 42813+40n	
[Md.408]	Cam reference position	42814+40n 42815+40n	
[Md.409]	Cam axis feed current value	42816+40n 42817+40n	
[Md.410]	Execute cam No.	42818+40n	
[Md.411]	Execute cam stroke amount	42820+40n 42821+40n	
[Md.420]	Main shaft clutch ON/OFF status	42828+40n	
[Md.421]	Main shaft clutch smoothing status	42829+40n	
[Md.422]	Main shaft clutch slippage (accumulative)	42830+40n 42831+40n	

n: Axis No.-1

Item		Buffer memory address	Reference section
[Md.423]	Auxiliary shaft clutch ON/OFF status	42832+40n	Section 4.7
[Md.424]	Auxiliary shaft clutch smoothing status	42833+40n	
[Md.425]	Auxiliary shaft clutch slippage (accumulative)	42834+40n 42835+40n	

n: Axis No.-1

(10) Cam operation control data

Item		Buffer memory address	Reference section
[Cd.600]	Cam data operation	Cam data operation request	Section 3.2.2
[Cd.601]		Operation cam No.	
[Cd.602]		Cam data first position	
[Cd.603]		Number of cam data operation points	
[Cd.604]		Cam data format	
[Cd.605]		Cam resolution/coordinate number	
[Cd.606]		Cam data starting point	
[Cd.607]		Cam data value	

Item		Buffer memory address	Reference section
[Cd.608]	Cam auto-generation	Cam auto-generation request	Section 3.2.3
[Cd.609]		Cam auto-generation cam No.	
[Cd.610]		Cam auto-generation type	
[Cd.611]		Cam auto-generation data <sup>(Note-1)</sup>	
		53204 to 53779	
[Cd.612]	Cam position calculation	Cam position calculation request	Section 5.5.1
[Cd.613]		Cam position calculation: Cam No.	
[Cd.614]		Cam position calculation: Stroke amount	
[Cd.615]		Cam position calculation: Cam axis length per cycle	
[Cd.616]		Cam position calculation: Cam reference position	
[Cd.617]		Cam position calculation: Cam axis current value per cycle	
[Cd.618]		Cam position calculation: Cam axis feed current value	
		53780 to 53791	

(Note-1): The item details on the cam auto-generation are shown below.

1) Cam auto-generation parameters for rotary cutter

Buffer memory address	Details
53204	Cam resolution
53206	Sheet length
53207	
53208	Sheet synchronous width
53209	
53210	Synchronous axis length
53211	
53212	Synchronization starting point
53213	
53214	Synchronous section acceleration ratio

(11) Cam operation monitor data

Item		Buffer memory address	Reference section
[Md.600]	Cam position calculation	Cam position calculation result	Section 5.5.2
		53800 to 53801	

(12) Command generation axis parameter

Item		Buffer memory address	Reference section
[Pr.340]	Command generation axis valid setting	_ (Note-1)	Section 2.2.2
[Pr.346]	Command generation axis length per cycle	_ (Note-1)	

(Note-1): It is not in the buffer memory. Refer to the following. Refer to Section 2.2.2 for details.

(13) Command generation axis control data

Item		Buffer memory address	Reference section
[Cd.3]	Positioning start No.	61860+128n	Section 2.2.3
[Cd.5]	Axis error reset	61862+128n	
[Cd.6]	Restart command	61863+128n	
[Cd.7]	M code OFF request	61864+128n	
[Cd.9]	New current value	61866+128n 61867+128n	
[Cd.10]	New acceleration time value	61868+128n 61869+128n	
[Cd.11]	New deceleration time value	61870 +128n 61871 +128n	
[Cd.12]	Acceleration/deceleration time change value during speed change, enable/disable	61872 +128n	
[Cd.13]	Positioning operation speed override	61873 +128n	
[Cd.14]	New speed value	61874 +128n 61875 +128n	
[Cd.15]	Speed change request	61876 +128n	
[Cd.17]	JOG speed	61878 +128n 61879 +128n	
[Cd.18]	Interrupt request during continuous operation	61880 +128n	
[Cd.23]	Speed-position switching control movement amount change register	61886 +128n 61887 +128n	
[Cd.24]	Speed-position switching enable flag	61888 +128n	
[Cd.27]	Target position change value (New address)	61894 +128n 61895 +128n	
[Cd.28]	Target position change value (New speed)	61896 +128n 61897 +128n	
[Cd.29]	Target position change request flag	61898 +128n	
[Cd.40]	ABS direction in degrees	61910 +128n	
[Cd.46]	Speed-position switching command	61927 +128n	
[Cd.180]	Axis stop	61960 +128n	
[Cd.181]	Forward run JOG start	61961 +128n	

n: Axis No.-1



Item		Buffer memory address	Reference section
[Cd.182]	Reverse run JOG start	61962 +128n	Section 2.2.3
[Cd.184]	Positioning start	61964 +128n	
[Cd.300]	Command generation axis parameter No. designation	61970+128n	
[Cd.301]	Command generation axis parameter setting value	61972+128n 61973+128n	
[Cd.302]	Command generation axis parameter control request	61971+128n	
[Cd.303]	Command generation axis positioning data No. designation	61974+128n	
[Cd.304]	Command generation axis positioning data designation	61975+128n	
[Cd.305]	Command generation axis positioning data setting value	61976+128n 61977+128n	
[Cd.306]	Command generation axis positioning data control request	61978+128n	

n: Axis No.-1

(14) Command generation axis monitor data

Item		Buffer memory address	Reference section
[Md.20]	Feed current value	60900+120n 60901+120n	Section 2.2.4
[Md.22]	Feedrate	60904+120n 60905+120n	
[Md.23]	Axis error No.	60906+120n	
[Md.24]	Axis warning No.	60907+120n	
[Md.25]	Valid M code	60908+120n	
[Md.26]	Axis operation status	60909+120n	
[Md.27]	Current speed	60910+120n 60911+120n	
[Md.28]	Axis feedrate	60912+120n 60913+120n	
[Md.29]	Speed-position switching control positioning movement amount	60914+120n 60915+120n	
[Md.31]	Status	60917+120n	
[Md.32]	Target value	60918+120n 60919+120n	
[Md.33]	Target speed	60920+120n 60921+120n	
[Md.38]	Start positioning data No. setting value	60929+120n	
[Md.39]	In speed limit flag	60930+120n	
[Md.40]	In speed change processing flag	60931+120n	

n: Axis No.-1

Item		Buffer memory address	Reference section	
[Md.42]	Control system repetition counter	60933+120n	Section 2.2.4	
[Md.44]	Positioning data No. being executed	60935+120n		
[Md.46]	Last executed positioning data No.	60937+120n		
[Md.47]	Positioning data being executed	Positioning identifier		60938+120n
		M code		60939+120n
		Dwell time		60940+120n
		Command speed		60942+120n 60943+120n
		Positioning address		60944+120n 60945+120n
[Md.48]	Deceleration start flag	60999+120n		
[Md.122]	Speed during command	60992+120n 60993+120n		
[Md.141]	BUSY	61004+120n		
[Md.345]	Command generation axis accumulative current value	61000+120n 61001+120n		
[Md.347]	Command generation axis current value per cycle	61002+120n 61003+120n		

n: Axis No.-1

# WARRANTY

---

Please confirm the following product warranty details before using this product.

## **1. Gratis Warranty Term and Gratis Warranty Range**

If any faults or defects (hereinafter "Failure") found to be the responsibility of Mitsubishi occurs during use of the product within the gratis warranty term, the product shall be repaired at no cost via the sales representative or Mitsubishi Service Company.

However, if repairs are required onsite at domestic or overseas location, expenses to send an engineer will be solely at the customer's discretion. Mitsubishi shall not be held responsible for any re-commissioning, maintenance, or testing on-site that involves replacement of the failed module.

[Gratis Warranty Term]

The gratis warranty term of the product shall be for one year after the date of purchase or delivery to a designated place. Note that after manufacture and shipment from Mitsubishi, the maximum distribution period shall be six (6) months, and the longest gratis warranty term after manufacturing shall be eighteen (18) months. The gratis warranty term of repair parts shall not exceed the gratis warranty term before repairs.

[Gratis Warranty Range]

- (1) The range shall be limited to normal use within the usage state, usage methods and usage environment, etc., which follow the conditions and precautions, etc., given in the instruction manual, user's manual and caution labels on the product.
- (2) Even within the gratis warranty term, repairs shall be charged for in the following cases.
  1. Failure occurring from inappropriate storage or handling, carelessness or negligence by the user. Failure caused by the user's hardware or software design.
  2. Failure caused by unapproved modifications, etc., to the product by the user.
  3. When the Mitsubishi product is assembled into a user's device, Failure that could have been avoided if functions or structures, judged as necessary in the legal safety measures the user's device is subject to or as necessary by industry standards, had been provided.
  4. Failure that could have been avoided if consumable parts (battery, backlight, fuse, etc.) designated in the instruction manual had been correctly serviced or replaced.
  5. Failure caused by external irresistible forces such as fires or abnormal voltages, and Failure caused by force majeure such as earthquakes, lightning, wind and water damage.
  6. Failure caused by reasons unpredictable by scientific technology standards at time of shipment from Mitsubishi.
  7. Any other failure found not to be the responsibility of Mitsubishi or that admitted not to be so by the user.

## **2. Onerous repair term after discontinuation of production**

- (1) Mitsubishi shall accept onerous product repairs for seven (7) years after production of the product is discontinued. Discontinuation of production shall be notified with Mitsubishi Technical Bulletins, etc.
- (2) Product supply (including repair parts) is not available after production is discontinued.

## **3. Overseas service**

Overseas, repairs shall be accepted by Mitsubishi's local overseas FA Center. Note that the repair conditions at each FA Center may differ.

## **4. Exclusion of loss in opportunity and secondary loss from warranty liability**

Regardless of the gratis warranty term, Mitsubishi shall not be liable for compensation to:

- (1) Damages caused by any cause found not to be the responsibility of Mitsubishi.
- (2) Loss in opportunity, lost profits incurred to the user by Failures of Mitsubishi products.
- (3) Special damages and secondary damages whether foreseeable or not, compensation for accidents, and compensation for damages to products other than Mitsubishi products.
- (4) Replacement by the user, maintenance of on-site equipment, start-up test run and other tasks.

## **5. Changes in product specifications**

The specifications given in the catalogs, manuals or technical documents are subject to change without prior notice.

# TRADEMARKS

---

Ethernet is a registered trademark of Fuji Xerox Co., Ltd. in Japan.

Microsoft and Windows are either registered trademarks or trademarks of Microsoft Corporation in the United States and/or other countries.

The company names, system names and product names mentioned in this manual are either registered trademarks or trademarks of their respective companies.

In some cases, trademark symbols such as <sup>™</sup> or <sup>®</sup> are not specified in this manual.



IB(NA)-0300174-J(1706)MEE

MODEL: LD77MH-U-SD-E

MODEL CODE: 1XB943

## **MITSUBISHI ELECTRIC CORPORATION**

HEAD OFFICE : TOKYO BUILDING, 2-7-3 MARUNOUCHI, CHIYODA-KU, TOKYO 100-8310, JAPAN  
NAGOYA WORKS : 1-14, YADA-MINAMI 5-CHOME, HIGASHI-KU, NAGOYA, JAPAN

When exported from Japan, this manual does not require application to the  
Ministry of Economy, Trade and Industry for service transaction permission.

Specifications subject to change without notice.